



























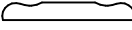











































































































































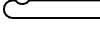













































































































































































# CUSTOM PROFILE TABLE OF CONTENTS Handrail

PROFILE	SIZE	PAGE	PROFILE	SIZE	PAGE	PROFILE	SIZE	PAGE			
KL 902P		3.250 x 2.250	1	KL 938		1.750 x 3.000	6	KL 970		1.25 x 2.25	13
KL 903P		3.250 x 2.250	1	KL 939		3.125 x 3.250	7	KL 971_6000F		.375 x 1.250	10
KL 904P		1.375 x 3.375	1	KL 939P		3.125 x 3.250	7	KL 972		3.000 x 3.000	14
KL 905		.687 x 1.437	1	KL 940B		2.500 x 2.725	7	KL 973P_6000S		.750 x 2.500	14
KL 906		.437 x 1.437	1	KL 941P		3.125 x 4.000	7	KL 974		2.133 x 2.250	14
KL 907		1.250 x 2.248	1	KL 942		1.562 x 7.500	8	KL 975		1.465 x 2.225	14
KL 908		1.500 x 4.250	1	KL 943		1.000 x 7.500	8	KL 976		.768 x 1.049	11
KL 909		1.500 x 5.500	1	KL 944		1.375 x 5.437	7	KL 977		.500 x 1.000	11
KL 910P		2.375 x 2.994	2	KL 945		1.500 x 4.500	9	KL 978P		3.300 x 3.502	14
KL 910B		2.375 x 3.000	2	KL 946		2.125 x 2.375	6	KL 979		2.875 x 1.875	14
KL 911		2.750 x 3.000	2	KL 946P		2.125 x 2.375	8	KL 980P		1.250 x 3.500	15
KL 913P		1.375 x 2.378	2	KL 946B		2.125 x 2.375	8	KL 981_6810		2.250 x 2.625	15
KL 914P		1.375 x 2.375	2	KL 947		1.500 x 3.500	6	KL 981B_6810B		2.250 x 2.625	15
KL 915P		1.375 x 3.375	2	KL 948		2.250 x 7.500	10	KL 982_6600		2.250 x 2.625	16
KL 916		1.375 x 3.375	2	KL 949_6042		1.281 x 2.250	8	KL 982P_6600P		2.250 x 2.625	16
KL 917		1.750 x 5.500	3	KL 950		4.000 x 3.500	9	KL 982B_6600B		2.250 x 2.625	16
KL 918		1.375 x 3.250	3	KL 951P_6005P		2.312 x 2.5	9	KL 983		2.375 x 2.250	16
KL 918P		1.375 x 3.250	3	KL 951_6005		2.312 x 2.5	9	KL 983B		2.375 x 2.250	16
KL 919P		1.375 x 3.250	3	KL 952B		1.625 x 1.749	10	KL 984		3.000 x 2.625	16
KL 920P_KLS 6010P		2.375 x 2.250	3	KL 953		1.5 x 5.5	11	KL 984B		3.000 x 2.625	17
KL 921P_6112P		2.375 x 2.250	3	KL 954P		2.5 x 3.5	11	KL 985_6601		2.250 x 2.250	17
KL 922 B		2.875 x 2.375	4	KL 955P_6900P		2.75 x 2.625	9	KL 985P_6601P		2.250 x 2.250	17
KL 922PO_6109P		2.875 x 2.375	4	KL 955_6900		2.749 x 2.625	10	KL 985B_6601B		2.250 x 2.250	17
KL 922P1_6109P		2.875 x 2.375	4	KL 955B		2.75 x 2.625	10	KL 986		1.750 x 3.000	17
KL 924B_KLS 6519B		3.000 x 2.625	4	KL 956_6109G		2.875 x 2.375	12	KL 987		2.125 x 3.250	17
KL 925B_6400B		2.250 x 3.031	5	KL 957		2.25 x 3	11	KL 987P		2.125 x 3.250	18
KL 926		.437 x 2.250	3	KL 958P		1.375 x 3.375	11	KL 988		2.375 x 3.125	18
KL 927B		1.000 x 3.125	4	KL 960_6003		1.625 x 5.5	12	KL 989		1.500 x 5.500	18
KL 929B		.750 x 2.500	4	KL 961B		2.75 x 2.625		KL 990		5.000 x 2.500	18
KL 931P		1.375 x 3.250	5	KL 961_6710		2.75 x 2.625	12	KL 991		1.750 x 5.500	19
KL 932P		1.375 x 3.250	5	KL 961P_6710P		2.75 x 2.625	12	KL 992		3.375 x 3.468	19
KL 933		2.375 x 2.750	5	KL 962_6203		1.625 x 5.375	13	KL 993		.500 x 1.500	16
KL 933P		2.375 x 2.750	5	KL 963_6203		1.625 x 5.5	13	KL 994		1.210 x 5.000	19
KL 934A		1.000 x 5.125	5	KL 964		2.125 x 2.875	12	KL 995P		4.000 x 3.375	20
KL 934B		1.500 x 6.625	6	KL 965P_6001P		1.625 x 2.75	13	KL 996		4.000 x 1.812	17
KL 935		1.250 x 3.750	5	KL 966P_6001P		.75 x 2.5		KL 997P		2.625 x 3.000	19
KL 936		2.500 x 4.500	6	KL 967		2 x 2.75	13	KL 4907		2.125 x 2.625	65
KL 937		1.500 x 3.500	6	KL 969		1.5 x 3.875	13	KL 4907P		2.125 x 2.625	66



















































































































# CUSTOM PROFILE TABLE OF CONTENTS **Handrail**

PROFILE	SIZE	PAGE	PROFILE	SIZE	PAGE	PROFILE	SIZE	PAGE			
KL 998		1.75 x 2.5	20	KL 1929P_6701P		2.125 x 2.750	28	KL 1965		1.500 x 5.500	35
KL 999		3.625 x 4.000	20	KL 1930P		3.500 x 8.000	28	KL 1966		1.250 x 5.250	36
KL 1900P		3.687 x 2.687	20	KL 1931P		3.500 x 8.000	29	KL 1967		1.750 x 4.500	36
KL 1901		2.000 x 3.000	20	KL 1932		3.250 x 2.625	28	KL 1968		1.250 x 4.500	36
KL 1902		2.375 x 2.875	21	KL 1933		2.094 x 2.750	28	KL 1969		1.750 x 3.250	35
KL 1902B		2.375 x 2.875	21	KL 1934P		2.812 x 4.668	30	KL 1970		1.625 x 3.000	36
KL 1903		.750 x 1.500	18	KL 1935		4.250 x 3.000	29	KL 1971		2.500 x 5.250	37
KL 1904		2.281 x 2.937	21	KL 1936		.750 x 2.500	27	KL 1972		1.500 x 5.500	37
KL 1905		2.375 x 2.875	21	KL 1937P		2.375 x 2.623	29	KL 1973		1.437 x 3.250	36
KL 1906B		1.625 x 2.750	21	KL 1938P		2.625 x 3.250	30	KL 1973P		1.437 x 3.250	37
KL 1906_6002		1.625 x 2.750	21	KL 1939P		1.500 x 2.625	30	KL 1974		1.437 x 2.500	36
KL 1906P		1.625 x 2.750	22	KL 1940P		4.000 x 3.750	31	KL 1975		1.750 x 4.000	38
KL 1907		3.504 x 7.500	22	KL 1941P		2.125 x 1.500	30	KL 1976		1.512 x 2.625	37
KL 1908P		.750 x 3.250	22	KL 1943		1.562 x 5.500	30	KL 1977		2.375 x 2.625	38
KL 1909P		.750 x 3.250	22	KL 1944		4.509 x 10.513	31	KL 1978P		3.500 x 5.000	38
KL 1910P		.750 x 2.500	22	KL 1945		1.000 x 5.500	31	KL 1979P		2.750 x 2.750	39
KL 1911P		3.450 x 3.375	23	KL 1946P		1.750 x 2.750	31	KL 1980P		2.886 x 3.000	39
KL 1912P		1.000 x 3.437	23	KL 1947P		1.750 x 2.750	32	KL 1981		1.375 x 4.375	37
KL 1913		.687 x 1.437	21	KL 1948		3.000 x 3.000	32	KL 1982		2.500 x 7.500	40
KL 1914		5.500 x 7.000	24	KL 1949		1.500 x 5.500	32	KL 1983P		2.625 x 2.000	38
KL 1915		5.500 x 7.000	25	KL 1950P		.687 x 2.000	29	KL 1984P		3.000 x 3.500	39
KL 1916		1.500 x 5.500	23	KL 1951		1.748 x 7.000	33	KL 1985		2.079 x 1.716	37
KL 1917		2.250 x 3.030	23	KL 1952P		1.922 x 2.000	32	KL 1985P		2.079 x 1.730	38
KL 1918		2.650 x 2.325	22	KL 1953P		2.312 x 3.062	32	KL 1986P		.750 x 2.375	37
KL 1919		1.562 x 5.500	24	KL 1954P		1.375 x 1.250	30	KL 1987P		2.500 x 2.500	39
KL 1920		3.200 x 4.421	26	KL 1955P		1.750 x 5.000	34	KL 1988P		1.125 x 3.000	38
KL 1921P		4.000 x 4.125	26	KL 1956		1.500 x 1.500	31	KL 1989		1.750 x 3.375	39
KL 1922		1.500 x 5.437	25	KL 1956B		1.500 x 1.500	31	KL 1990		.875 x 2.500	39
KL 1923A		1.537 x 2.230	23	KL 1957P		2.500 x 2.625	33	KL 1991P		1.500 x 2.500	40
KL 1923B		1.213 x 2.500	23	KL 1958P		1.000 x 2.625	33	KL 1992P		1.500 x 2.750	40
KL 1924		1.250 x 3.250	27	KL 1959		3.375 x 4.562	33	KL 1993P		1.500 x 2.750	40
KL 1925		2.375 x 2.250	26	KL 1960		1.000 x 2.360	34	KL 1994		1.500 x 3.000	41
KL 1926		3.625 x 2.625	26	KL 1961B		2.312 x 2.375	34	KL 1995		2.250 x 3.375	40
KL 1926P		3.625 x 2.625	27	KL 1961P_6B10P		2.312 x 2.374	34	KL 1996		2.000 x 4.000	41
KL 1927P		1.000 x 2.625	27	KL 1961_6B10		2.312 x 2.375	34	KL 1996P		2.000 x 4.000	41
KL 1928		2.750 x 3.250	27	KL 1962P		1.000 x 4.250	35	KL 1997B		1.359 x 1.500	38
KL 1928P		2.750 x 3.250	27	KL 1963P		2.000 x 5.000	35	KL 1997		1.359 x 1.500	41
KL 1929_6701		2.125 x 2.750	27	KL 1964P		1.750 x 2.625	35	KL 1997P		1.359 x 1.500	41



















































































































# CUSTOM PROFILE TABLE OF CONTENTS Handrail

PROFILE	SIZE	PAGE	PROFILE	SIZE	PAGE	PROFILE	SIZE	PAGE			
KL 1998		.312 x 1.750	40	KL3923P		2.750 x 2.651	48	KL 3950P		2.750 x 3.250	53
KL 1999		1.500 x 7.250	42	KL 3923		2.750 x 2.651	48	KL 3951		2.375 x 2.625	53
KL 3900		1.500 x 4.000	41	KL 3923B		2.750 x 2.651	48	KL 3951P		2.375 x 2.625	54
KL 3900P		1.500 x 4.000	42	KL 3924		1.250 x 5.500	47	KL 3952		1.500 x 5.500	54
KL 3901P		.750 x 2.250	41	KL 3925		2.688 x 2.750	48	KL 3953		.875 x 3.156	52
KL 3902		2.250 x 2.875	42	KL 3926		2.125 x 2.625	48	KL 3954		2.625 x 2.625	54
KL 3902B		2.250 x 2.875	42	KL 3926P		2.125 x 2.625	48	KL 3954P		2.625 x 2.625	54
KL 3903P		1.500 x 5.125	43	KL 3927B		2.500 x 3.500	49	KL 3955		1.750 x 2.625	54
KL 3904		2.312 x 3.375	43	KL 3927P		2.500 x 3.500	49	KL 3956		2.750 x 2.750	55
KL 3904B		2.312 x 3.375	43	KL 3928		1.750 x 4.437	49	KL 3956P		2.750 x 2.750	55
KL 3905		1.750 x 3.437	43	KL 3929		1.500 x 4.500	49	KL 3957P		1.375 x 5.375	55
KL 3905B		1.750 x 3.437	43	KL 3930		2.000 x 4.000	50	KL 3958		2.250 x 3.375	55
KL 3906		2.671 x 3.000	44	KL 3931		3.500 x 3.500	50	KL 3959		1.500 x 5.500	56
KL 3907		1.866 x 2.000	42	KL 3932		1.250 x 4.437	49	KL 3960P		2.500 x 3.375	55
KL 3907P		1.866 x 2.000	42	KL 3933		2.375 x 2.750	50	KL 3961		2.125 x 2.750	56
KL 3907B		1.866 x 2.000	44	KL 3933P		2.375 x 2.750	50	KL 3961P		2.125 x 2.750	56
KL 3908B		2.687 x 3.500	44	KL 3934P		1.000 x 3.500	50	KL 3961B		2.125 x 2.750	56
KL 3908		2.687 x 4.500	45	KL 3935		2.375 x 2.375	49	KL 3962B		1.875 x 2.000	56
KL 3908P		2.687 x 4.500	45	KL 3935 P		2.375 x 2.375	49	KL 3963P		1.000 x 1.500	55
KL 3909		2.979 x 3.000	44	KL 3935B		2.375 x 2.375	50	KL 3964		3.750 x 3.500	57
KL 3909B		3.000 x 3.000	46	KL 3936P		2.000 x 3.000	51	KL 3964P		3.750 x 3.500	57
KL 3910		1.000 x 2.250	43	KL 3937		2.625 x 2.875	51	KL 3964B		3.750 x 3.500	57
KL 3911		1.500 x 3.000	44	KL 3937P		2.625 x 2.875	51	KL 3965		1.750 x 3.562	58
KL 3912		2.000 x 2.000	44	KL 3938		2.000 x 2.750	51	KL 3966		1.500 x 2.437	56
KL 3912B		2.000 x 2.000	45	KL 3939P		1.625 x 2.500	51	KL 3967		2.250 x 3.750	58
KL 3913B		1.750 x 1.750	44	KL 3940P		2.625 x 3.250	51	KL 3968		1.515 x 7.250	58
KL 3914		3.500 x 3.437	46	KL 3941P		1.375 x 2.625	52	KL 3969		2.312 x 2.813	57
KL 3915		1.500 x 3.437	45	KL 3942		1.780 x 1.780	52	KL 3970		1.750 x 3.750	59
KL 3916		2.187 x 3.875	46	KL 3942B		1.780 x 1.780	52	KL 3972		1.687 x 6.250	59
KL 3917		1.625 x 2.625	45	KL 3943		1.562 x 2.125	52	KL 3973		2.312 x 3.437	59
KL 3917P		1.625 x 2.625	46	KL 3944		1.812 x 2.750	52	KL 3974		1.500 x 5.500	60
KL 3918		1.500 x 3.437	46	KL 3945		2.250 x 3.000	52	KL 3975		2.687 x 2.875	58
KL 3919		3.500 x 3.437	47	KL 3945P		2.250 x 3.000	52	KL 3976		2.750 x 2.875	59
KL 3920P		3.625 x 3.000	47	KL 3946P		1.125 x 2.750	52	KL 3977		3.000 x 3.000	60
KL 3921B		2.500 x 2.625	46	KL 3947		1.500 x 2.125	53	KL 3978		2.375 x 2.125	60
KL 3921		2.500 x 2.750	47	KL 3948		1.500 x 2.750	53	KL 3978P		2.375 x 2.125	60
KL 3921P		2.500 x 2.750	47	KL 3949		1.625 x 2.500	53	KL 3978B		2.375 x 2.125	60
KL 3922		3.000 x 2.500	45	KL 3949B		1.625 x 2.500	53	KL 3979P		3.000 x 3.500	61



















































































































# CUSTOM PROFILE TABLE OF CONTENTS Handrail

PROFILE	SIZE	PAGE	PROFILE	SIZE	PAGE	PROFILE	SIZE	PAGE			
KL 3980		3.625 x 4.500	61	KL 4914		2.750 x 3.250	68	KL 4948P		2.250 x 5.500	76
KL 3981		2.625 x 2.625	61	KL 4914 P		2.750 x 3.250	69	KL 4950		3.625 x 2.625	76
KL 3981B		2.625 x 2.625	62	KL 4915P		3.500 x 4.000	69	KL 4951		1.625 x 2.750	74
KL 3982P		1.406 x 3.500	62	KL 4916P		1.500 x 4.000	67	KL 4952		2.000 x 2.750	74
KL 3983		2.250 x 3.500	62	KL 4917P		3.000 x 4.000	70	KL 4953		3.218 x 2.625	77
KL 3983B		2.250 x 3.500	62	KL 4918P		2.062 x 2.250	67	KL 4954		1.531 x 2.250	73
KL 3984		1.875 x 2.500	60	KL 4919		1.078 x 3.000	68	KL 4955		1.750 x 2.750	75
KL 3985P		3.062 x 2.750	62	KL 4920		1.812 x 3.250	68	KL 4956		2.500 x 2.750	76
KL 3986		2.500 x 3.500	62	KL 4921		1.562 x 2.750	69	KL 4956P		2.500 x 2.750	76
KL 3988P		2.500 x 3.000	63	KL 4921P		1.687 x 2.750	69	KL 4957		2.623 x 2.875	77
KL 3989		1.250 x 3.000	63	KL 4922P		1.375 x 2.750	69	KL 4958P		2.689 x 2.750	77
KL 3990		4.000 x 2.625	63	KL 4923		2.125 x 2.500	69	KL 4959		2.250 x 2.625	77
KL 3991		1.421 x 2.625	63	KL 4924P		2.250 x 2.750	70	KL 4960P		2.312 x 2.250	74
KL 3991P		1.421 x 2.625	63	KL 4925P		3.750 x 2.688	70	KL 4961		2.000 x 3.500	77
KL 3992P		2.000 x 4.500	63	KL 4926		2.438 x 3.500	71	KL 4961B		2.000 x 3.500	78
KL 3993P		2.000 x 2.250	61	KL 4927P		2.750 x 2.750	71	KL 4962P		3.650 x 3.250	78
KL 3994		1.500 x 5.437	64	KL 4928P		2.750 x 2.750	71	KL 4963P		2.000 x 3.250	78
KL 3995		4.500 x 2.750	64	KL 4930P		2.750 x 3.000	71	KL 4964		1.500 x 5.500	75
KL 3995P		4.500 x 2.750	64	KL 4931P		2.750 x 3.500	72	KL 4965		1.750 x 2.375	78
KL 3996		.875 x 2.250	61	KL4931B		2.750 x 3.500	72	KL 4966		1.500 x 5.500	79
KL 3997		1.500 x 5.500	64	KL 4932P		2.750 x 4.500	72	KL 4967		3.500 x 3.125	78
KL 3998		1.750 x 2.750	65	KL 4932B		2.750 x 4.500	73	KL 4968		1.750 x 2.625	79
KL 3999		1.750 x 2.250	63	KL 4933		1.250 x 2.000	70	KL 4968P		1.750 x 2.625	79
KL 4900		3.500 x 2.625	65	KL 4935		1.750 x 2.750	71	KL 4969		1.562 x 5.437	79
KL 4900P		3.500 x 2.625	65	KL 4936		1.375 x 2.875	70	KL 4970		1.807 x 2.750	79
KL 4901		5.000 x 3.000	66	KL 4937		1.500 x 3.000	70	KL 4971P		1.813 x 2.500	79
KL 4902		1.437 x 2.625	65	KL 4938P		1.500 x 3.500	72	KL 4972P		1.813 x 2.500	80
KL 4903		3.500 x 2.250	65	KL 4939		3.312 x 3.000	73	KL 4973		2.375 x 2.250	80
KL 4904		3.375 x 1.875	66	KL 4940P		1.812 x 3.250	73	KL 4973B		2.375 x 2.250	80
KL 4905P		2.500 x 3.563	66	KL 4941P		2.375 x 4.500	74	KL 4974		1.750 x 2.500	80
KL 4906P		2.625 x 3.187	67	KL 4942		.562 x 2.484	72	KL 4975P		1.000 x 3.000	80
KL 4908		2.375 x 1.750	67	KL 4943P		1.625 x 2.625	73	KL 4976P		1.000 x 2.500	77
KL 4909P		2.500 x 2.500	67	KL 4944		2.250 x 2.625	74	KL 4977		.250 x 1.750	78
KL 4910		2.750 x 3.250	67	KL 4944B		2.250 x 2.625	74	KL 4978		2.625 x 3.062	80
KL 4911P		1.500 x 2.000	66	KL 4945		3.062 x 3.938	75	KL 4978P		2.625 x 3.062	81
KL 4912		2.500 x 3.250	68	KL 4945P		3.062 x 3.938	75	KL 4979P		1.125 x 2.000	78
KL 4913P		2.250 x 2.625	68	KL 4946		2.750 x 3.250	76	KL 4980P		3.125 x 3.688	81
KL 4914B		2.750 x 3.250	68	KL 4947		2.256 x 2.646	75	KL 4981B		1.750 x 2.625	81



















































































































# CUSTOM PROFILE TABLE OF CONTENTS **Handrail**

PROFILE	SIZE	PAGE	PROFILE	SIZE	PAGE	PROFILE	SIZE	PAGE
KL 4983		1.750 x 2.750 81	KL 5917P		1.500 x 2.000 87	KL 5951P		1.563 x 2.750 95
KL 4984		2.203 x 2.453 81	KL 5918		3.750 x 3.500 89	KL 5952P		1.562 x 2.750 95
KL 4985		1.719 x 3.500 81	KL 5919P		1.750 x 2.750 88	KL 5953		1.562 x 2.750 95
KL 4986P		2.250 x 5.250 82	KL 5920		1.500 x 2.250 88	KL 5954P		3.000 x 3.000 95
KL 4987		3.250 x 3.000 82	KL 5921P		4.000 x 5.750 90	KL 5955		2.375 x 3.000 95
KL 4988		2.687 x 3.062 82	KL 5922P		2.000 x 3.250 89	KL 5955P		2.375 x 3.000 95
KL 4989		2.750 x 2.750 83	KL 5923		1.875 x 3.000 89	KL 5956		3.375 x 3.500 96
KL 4989P		2.750 x 2.750 83	KL 5924P		1.563 x 2.750 89	KL 5957		1.875 x 2.750 96
KL 4990		2.250 x 2.531 82	KL 5925P		1.860 x 2.000 90	KL 5957P		1.875 x 2.750 96
KL 4991P		3.343 x 3.500 83	KL 5926		2.765 x 3.015 90	KL 5958P		1.563 x 2.750 96
KL 4992P		1.750 x 2.750 82	KL 5927		1.625 x 2.750 89	KL 5959P		1.500 x 2.250 96
KL 4993P		1.750 x 3.125 83	KL 5928		1.500 x 2.000 89	KL 5960		2.250 x 2.750 96
KL 4994P		1.687 x 2.750 83	KL 5928B		1.875 x 2.000 91	KL 5960P		2.250 x 2.750 97
KL 4994B		1.683 x 2.750 84	KL 5929		3.100 x 2.661 91	KL 5961P		2.000 x 5.000 97
KL 4995		1.500 x 5.062 84	KL 5930		1.437 x 4.000 91	KL 5962P		1.250 x 3.000 96
KL4996		2.250 x 1.500 82	KL 5933P		3.062 x 2.750 91	KL 5963		2.400 x 3.031 97
KL 4997		2.000 x 3.500 84	KL 5934P		1.281 x 2.250 88	KL 5964		3.000 x 3.625 97
KL 4998		1.281 x 2.500 83	KL 5935		1.625 x 2.000 90	KL 5965		1.813 x 2.625 97
KL 4999P		3.125 x 2.500 84	KL 5935P		1.625 x 2.000 91	KL 5966		2.000 x 5.000 98
KL 5900P		2.000 x 3.062 85	KL 5936B		1.187 x 1.125 91	KL 5967P		1.000 x 2.250 98
KL 5901P		2.125 x 2.750 85	KL 5936		2.375 x 2.250 92	KL 5968P		1.750 x 2.640 98
KL 5902		3.125 x 5.000 85	KL 5936P		2.375 x 2.250 92	KL 5969P		1.781 x 3.313 98
KL 5903P		2.625 x 2.500 86	KL 5937P		.812 x 2.687 90	KL 5970		3.437 x 3.688 99
KL 5904B		2.500 x 3.031 86	KL 5938P		.813 x 2.813 91	KL 5970P		3.437 x 3.688 99
KL 5904		2.500 x 3.031 86	KL 5939		2.250 x 4.438 92	KL 5971		2.125 x 2.500 98
KL 5905		2.000 x 5.000 85	KL 5940		2.750 x 4.000 92	KL 5972		2.250 x 3.391 100
KL 5906P		1.625 x 2.750 84	KL 5941P		2.000 x 4.500 93	KL 5973		2.343 x 2.218 99
KL 5907		2.375 x 2.750 86	KL 5942		2.750 x 3.000 93	KL 5974P		1.625 x 2.625 99
KL 5908P		2.200 x 2.980 86	KL 5942P		2.750 x 3.000 93	KL 5975P		2.719 x 2.234 99
KL5909P		1.750 x 4.000 86	KL 5943		2.250 x 2.250 92	KL 5976P		2.400 x 6.500 100
KL 5910		2.750 x 3.750 87	KL 5944		3.750 x 3.500 94	KL 5977		2.750 x 2.500 100
KL 5911		3.625 x 3.690 87	KL 5944P		3.750 x 3.500 94	KL 5977P		2.750 x 2.500 100
KL 5912P		3.937 x 4.187 88	KL 5944B		3.750 x 3.500 94	KL 5978		2.375 x 3.375 101
KL 5913P		2.187 x 3.312 88	KL 5945P		1.625 x 2.625 93	KL 5979		1.500 x 5.500 101
KL 5914		2.375 x 3.500 88	KL 5946P		1.333 x 1.562 92	KL 5980		2.000 x 3.500 101
KL 5914P		2.375 x 3.500 89	KL 5948		1.375 x 2.750 93	KL 5981P		3.312 x 3.250 101
KL 5915P		2.375 x 2.250 87	KL5949P		1.000 x 2.125 93	KL 5982		3.850 x 2.850 102
KL 5916P		2.500 x 2.875 87	KL 5950		3.375 x 2.375 94	KL 5983P		2.500 x 3.250 101



















































































































# CUSTOM PROFILE TABLE OF CONTENTS **Handrail**

PROFILE	SIZE	PAGE	PROFILE	SIZE	PAGE	PROFILE	SIZE	PAGE
KL 5984		2.687 x 2.250 102	KL 6914P		.875 x 2.250 107	KL 6945		3.438 x 2.562 113
KL 5985		1.750 x 4.000 102	KL 6915P		1.562 x 2.750 107	KL 6946P		1.914 x 2.000 110
KL 5986B		2.500 x 3.500 102	KL 6916		2.157 x 2.716 107	KL 6947P		1.754 x 2.000 113
KL 5987P		3.000 x 1.750 103	KL 6916P		2.157 x 2.716 107	KL 6949B		2.000 x 5.500 114
KL 5988		2.000 x 2.750 100	KL 6917		1.281 x 2.250 108	KL 6951P		2.312 x 2.750 113
KL 5988P		2.000 x 2.750 102	KL 6918		1.832 x 2.250 108	KL 6952-2		2.439 x 2.000 114
KL 5989		1.500 x 5.500 103	KL 6919		2.750 x 2.750 108	KL 6952-1		2.561 x 2.750 114
KL 5990		2.000 x 2.500 102	KL 6919B		2.750 x 2.750 108	KL 6952B		2.750 x 4.250 115
KL 5991		1.750 x 2.625 103	KL 6920		1.562 x 1.687 106	KL 6953P		1.692 x 1.750 113
KL 5992		2.250 x 3.000 103	KL 6921		2.250 x 4.125 108	KL 6954P		1.563 x 2.875 115
KL 5992P		2.250 x 3.000 103	KL 6922		2.265 x 2.375 108	KL 6955		2.250 x 2.250 114
KL 5993		2.250 x 2.250 103	KL 6923P		1.500 x 2.000 108	KL 6956		1.438 x 2.312 113
KL 5993P		2.250 x 2.250 104	KL 6924P		3.312 x 5.000 109	KL 6957		1.250 x 2.250 114
KL 5994		.875 x 2.250 104	KL 6925		1.500 x 3.500 109	KL 6958		2.500 x 2.625 115
KL 5994B		.875 x 2.250 104	KL 6926		1.750 x 2.750 109	KL 6959P		2.000 x 4.500 115
KL 5995P		1.000 x 1.750 104	KL 6926P		1.750 x 2.750 109	KL 6960P		1.750 x 2.750 116
KL 5996		.750 x 2.500 104	KL 6927P		1.687 x 3.500 109	KL 6961		1.625 x 2.250 114
KL 5997		1.750 x 2.750 104	KL 6928		2.250 x 2.250 110	KL 6963		1.750 x 2.250 115
KL 5998		2.750 x 2.750 104	KL 6928P		2.250 x 2.250 110	KL 6964P		2.312 x 2.750 116
KL 5998P		2.750 x 2.750 104	KL 6929P		3.000 x 3.000 110	KL 6965		1.500 x 2.500 116
KL 5998B		2.750 x 2.750 105	KL 6930		2.000 x 2.000 109	KL 6966P		1.375 x 3.188 116
KL 5999		1.375 x 1.875 104	KL 6931		2.344 x 4.000 110	KL 6967		1.875 x 2.875 116
KL6900		1.500 x 3.000 105	KL 6932		2.000 x 3.500 110	KL 6968P		3.687 x 2.562 116
KL6900P		1.375 x 3.000 105	KL 6933P		2.500 x 2.750 110	KL 6969P		2.500 x 3.500 117
KL6901		1.750 x 2.750 105	KL 6934		2.375 x 2.625 111	KL 6970		2.250 x 2.500 117
KL 6902P		2.250 x 3.000 105	KL 6934P		2.375 x 2.625 111	KL 6971		3.500 x 3.500 117
KL6903		1.000 x 2.000 104	KL 6935		2.000 x 3.000 111	KL 6972P		2.750 x 7.250 118
KL 6904P		1.437 x 3.500 105	KL 6935B		2.000 x 3.000 111	KL 6973P		2.375 x 3.250 117
KL6905		2.000 x 3.500 106	KL 6936P		1.563 x 2.750 111	KL 6974		1.750 x 2.500 117
KL 6906		1.500 x 2.750 105	KL 6937		1.750 x 2.500 111	KL 6975P		2.750 x 2.875 118
KL 6906P		1.500 x 2.750 106	KL 6938		2.500 x 2.750 112	KL 6976		2.500 x 2.813 118
KL 6907P		1.500 x 3.563 106	KL 6939		2.482 x 2.836 112	KL 6976P		2.500 x 2.813 119
KL 6908		3.000 x 2.875 106	KL 6940P		1.500 x 3.000 112	KL 6977		2.312 x 3.875 118
KL 6909P		1.156 x 2.250 106	KL 6941P		1.125 x 3.000 112	KL 6978		3.594 x 2.500 119
KL 6910		2.250 x 2.250 106	KL 6942		2.375 x 3.000 112	KL 6979		1.750 x 2.500 118
KL 6911		1.500 x 5.500 107	KL 6943		2.512 x 2.656 112	KL 6979P		1.592 x 2.500 117
KL 6912		2.250 x 2.500 106	KL 6943P		2.512 x 2.656 113	KL 6980		1.875 x 3.500 119
KL 6913P		3.625 x 3.313 107	KL 6944P		2.000 x 4.000 113	KL 6981P		3.000 x 2.312 119

# CUSTOM PROFILE TABLE OF CONTENTS Handrail









































































PROFILE	SIZE	PAGE	PROFILE	SIZE	PAGE	PROFILE	SIZE	PAGE			
KL 6982P		2.451 x 2.625	120	KL 7917		1.250 x 4.500	124	KL 7947		1.500 x 2.000	130
KL 6983		2.125 x 3.375	119	KL 7918P		2.750 x 3.437	124	KL 7948P		2.125 x 2.750	130
KL 6984P		1.563 x 2.250	120	KL 7920		2.500 x 2.500	124	KL 7949		1.625 x 2.000	130
KL 6985		1.500 x 3.000	120	KL 7921P		1.250 x 3.500	124	KL 7950		2.250 x 3.750	130
KL 6986B		1.062 x 1.250	119	KL 7922		1.750 x 2.500	125	KL 7951		1.750 x 3.750	130
KL 6987		1.250 x 1.250	119	KL 7923P		1.187 x 2.188	125	KL 7952		1.750 x 3.750	131
KL 6987B		1.250 x 1.250	120	KL 7924		2.000 x 2.625	125	KL 7953P		1.562 x 3.000	130
KL 6988		1.687 x 2.625	120	KL 7924P		2.000 x 2.625	125	KL 7954P		1.625 x 1.750	130
KL 6989		1.562 x 2.250	120	KL 7926		.625 x 1.500	122	KL 7955P		2.000 x 3.500	131
KL 6990		2.281 x 3.343	120	KL 7927		2.000 x 3.156	125	KL 7956P		2.375 x 2.250	131
KL 6991		1.281 x 2.375	121	KL 7928		3.094 x 3.059	125	KL 7957P		2.093 x 2.500	131
KL 6991P		1.281 x 2.375	121	KL 7929		1.500 x 5.500	126	KL 7958		1.625 x 2.625	130
KL 6992P		2.250 x 2.250	121	KL 7930		3.000 x 2.250	126	KL 7959		2.875 x 2.750	131
KL 6993P		1.937 x 3.000	121	KL 7930P		3.000 x 2.250	126	KL 7960P		2.375 x 2.220	131
KL 6994		.313 x .937	118	KL 7931		1.625 x 2.625	126	KL 7961		2.500 x 2.750	132
KL 6995		1.625 x 2.500	121	KL 7931P		1.625 x 2.625	126	KL 7962		3.532 x 2.762	132
KL 6996		1.093 x 1.500	120	KL 7932		1.562 x 2.875	127	KL 7963P		1.500 x 3.250	132
KL 6997		1.750 x 4.000	121	KL 7933BR		2.375 x 2.250	127	KL 7964		1.500 x 2.000	132
KL 6998P		1.000 x 2.000	121	KL 7933		1.969 x 3.750	127	KL 7965P		1.500 x 4.500	132
KL 6999P		1.500 x 4.000	121	KL 7934		2.125 x 1.750	127	KL 7966		2.250 x 4.500	133
KL 7900		1.250 x 2.250	121	KL 7934P		2.125 x 1.750	127	KL 7967P		2.000 x 2.250	132
KL 7901P		1.719 x 2.750	122	KL 7935		2.812 x 3.944	127	KL 7968		2.875 x 2.750	133
KL 7902		1.375 x 2.625	122	KL 7935BR		2.812 x 3.944	128	KL 7969P		1.281 x 2.250	133
KL 7903		1.000 x 2.000	122	KL 7936BR		1.875 x 1.875	128	KL 7970		2.750 x 3.125	133
KL 7904		2.250 x 3.593	122	KL 7937		2.250 x 3.000	128	KL 7971		2.375 x 2.375	133
KL 7905P		1.728 x 1.750	122	KL 7937P		2.250 x 3.000	128	KL 7972		2.500 x 2.500	133
KL 7906		1.312 x 2.250	122	KL 7938		2.500 x 3.500	128	KL 7973		1.625 x 2.625	134
KL 7907B		2.375 x 3.125	123	KL 7939		1.750 x 2.750	128	KL 7974P		2.375 x 3.250	134
KL 7907P		2.375 x 3.125	123	KL 7939P		1.750 x 2.750	129	KL 7975		1.625 x 2.625	134
KL 7908		2.000 x 2.125	122	KL 7940P		1.687 x 3.688	129	KL 7976		2.375 x 2.625	134
KL 7909P		3.438 x 2.469	123	KL 7941		2.250 x 2.375	129	KL 7977P		3.250 x 2.500	134
KL 7910		1.344 x 2.406	122	KL 7941BR		2.250 x 2.375	129	KL 7978P		1.125 x 1.750	131
KL 7911		.781 x 2.438	122	KL 7942		1.000 x 2.125	126	KL 7979		1.750 x 2.625	134
KL 7912		3.000 x 3.562	123	KL 7942P		1.000 x 2.125	126	KL 7980P		1.500 x 3.000	135
KL 7913P		2.250 x 3.250	123	KL 7943P		1.562 x 3.000	129	KL 7981		1.945 x 3.407	135
KL 7914P		1.125 x 2.250	123	KL 7944		1.625 x 2.375	126	KL 7982		2.375 x 3.500	135
KL 7915		1.750 x 2.750	124	KL 7945P		2.375 x 2.250	129	KL 7983P		1.562 x 2.750	135
KL 7916		2.250 x 2.625	124	KL 7946		1.500 x 2.000	129	KL 7984		4.000 x 3.000	135

# CUSTOM PROFILE TABLE OF CONTENTS Handrail

PROFILE	SIZE	PAGE	PROFILE	SIZE	PAGE	PROFILE	SIZE	PAGE			
KL 7984P		4.000 x 3.000	136	KL 9917		2.688 x 4.437	142	KL 9952P		2.250 x 2.625	149
KL 7985P		1.875 x 2.500	135	KL 9918		2.750 x 3.000	143	KL 9953		1.875 x 2.750	149
KL 7986P		3.500 x 3.500	136	KL 9919 P		3.562 x 3.313	143	KL 9954P		1.500 x 2.250	149
KL 7987P		1.625 x 2.750	136	KL 9919B		2.500 x 3.500	143	KL 9955		1.562 x 2.750	149
KL 7988		1.750 x 1.500	133	KL 9920 P		1.125 x 1.750	142	KL 9956		2.625 x 2.625	149
KL 7988P		1.750 x 1.500	134	KL 9921		1.750 x 2.500	142	KL 9957		1.500 x 2.250	150
KL 7989		2.250 x 2.750	136	KL 9921B		1.750 x 2.500	143	KL 9958		2.140 x 4.475	150
KL 7990		2.312 x 2.625	137	KL 9922		1.250 x 4.750	144	KL 9959		1.500 x 2.250	150
KL 7991		2.750 x 6.250	137	KL 9923P		1.625 x 2.500	144	KL 9960P		3.000 x 7.000	150
KL 7991P		2.750 x 6.250	138	KL 9924P		1.469 x 2.250	142	KL 9961P		4.000 x 4.750	151
KL 7992		1.718 x 2.625	136	KL 9925		3.437 x 2.406	144	KL 9962P		2.125 x 2.750	151
KL 7993		2.250 x 3.250	137	KL 9926P		3.000 x 2.375	144	KL 9963		2.750 x 3.500	151
KL 7994 P		2.125 x 2.250	137	KL 9927		2.281 x 4.219	144	KL 9964		1.750 x 4.380	152
KL 7995P		2.687 x 3.500	138	KL 9928P		2.101 x 2.500	145	KL 9965P		1.624 x 2.625	152
KL 7996P		1.938 x 2.750	137	KL 9929P		2.500 x 4.000	145	KL 9966		2.062 x 4.500	152
KL 7997		2.500 x 2.750	138	KL 9930		.813 x 3.000	143	KL 9967		1.875 x 2.625	153
KL 7997P		2.500 x 2.750	139	KL 9931		1.625 x 2.500	145	KL 9968P		2.000 x 2.000	151
KL 7998		2.250 x 2.250	138	KL 9932		2.750 x 3.750	145	KL 9970		2.500 x 2.750	153
KL 7999		1.875 x 2.625	138	KL 9932P		2.750 x 3.750	146	KL 9971		2.313 x 2.750	153
KL 9900P		3.250 x 4.625	139	KL 9933		2.500 x 5.625	146	KL 9972		2.269 x 3.188	153
KL 9901		2.750 x 4.500	140	KL 9934		2.500 x 3.625	147	KL 9973P		2.563 x 2.937	153
KL 9902		3.000 x 2.750	140	KL 9935		1.844 x 2.469	145	KL 9974P		1.500 x 2.500	151
KL 9903		2.187 x 2.750	139	KL 9936		1.875 x 3.250	145	KL 9975P		3.250 x 3.125	154
KL 9904		2.875 x 2.250	139	KL 9937P		2.500 x 3.500	147	KL 9976		1.500 x 3.000	152
KL 9905		1.875 x 3.188	139	KL 9938		1.938 x 3.250	146	KL 9977P		2.250 x 2.375	152
KL 9905B		2.500 x 3.500	140	KL 9939		2.125 x 2.938	146	KL 9978		1.625 x 2.625	153
KL 9906		2.250 x 3.750	140	KL 9940		1.438 x 2.625	146	KL 9979P		2.243 x 2.500	154
KL 9907		1.625 x 4.500	141	KL 9941		2.750 x 2.750	147	KL 9980P		1.875 x 2.813	154
KL 9908		2.562 x 2.625	141	KL 9942		2.300 x 2.250	147	KL 9981		2.031 x 3.000	154
KL 9909		3.125 x 6.000	141	KL 9943P		2.125 x 4.125	147	KL 9982		2.125 x 2.625	154
KL 9910P		1.562 x 2.250	140	KL 9944		1.688 x 3.500	148	KL 9983		2.385 x 5.056	155
KL 9910		1.562 x 2.250	139	KL 9945		1.250 x 2.250	145	KL 9984		1.563 x 3.500	152
KL 9911		2.250 x 5.000	142	KL 9946P		2.375 x 3.844	148	KL 9985		1.779 x 8.236	156
KL 9912		2.625 x 4.031	142	KL 9947		1.687 x 2.000	148	KL 9986		2.438 x 2.229	155
KL 9913		1.375 x 3.500	141	KL 9948		3.250 x 2.625	148	KL 9987		2.375 x 3.438	155
KL 9914		1.328 x 2.750	140	KL 9949		2.500 x 2.750	148	KL 9988		2.563 x 2.688	155
KL 9915		1.500 x 2.750	142	KL 9950		2.250 x 2.250	148	KL 9989		2.125 x 2.625	154
KL 9916		1.500 x 2.250	141	KL 9951P		2.500 x 2.750	149	KL 9990		1.476 x 1.500	154



# CUSTOM PROFILE TABLE OF CONTENTS Handrail

PROFILE	SIZE	PAGE	PROFILE	SIZE	PAGE	PROFILE	SIZE	PAGE
KL 9991P		1.750 x 2.750	155	KL 11933 P		2.500 x 2.399	162	
KL 9992		2.000 x 3.500	156	KL 11934		2.750 x 2.750	162	
KL 9993		4.000 x 2.875	156	KL 11935		3.000 x 2.000	161	
KL 9995P		3.063 x 2.887	157	KL 11936P		2.250 x 2.250	162	
KL 9996P		1.900 x 2.463	157	KL 11937		2.375 x 2.875	163	
KL 9997		2.875 x 2.250	157	KL 11939		2.125 x 2.499	163	
KL 9998P		.875 x 2.250	156	KL 11941		3.125 x 3.500	164	
KL 9999		1.784 x 5.906	158	KL 11942 P		1.500 x 2.500	164	
KL 11900		2.688 x 4.500	157	KL 11944 P		4.000 x 4.159	164	
KL 11901P		2.750 x 2.750	158	KL 11945		1.484 x 3.500	165	
KL 11902		3.000 x 3.000	158	KL 11946 P		2.875 x 2.750	164	
KL 11903P		1.812 x 2.625	157	KL 11947 P		1.897 x 5.750	165	
KL 11904		1.750 x 5.500	158	KL 11948 P		.813 x 3.000	163	
KL 11905		2.125 x 2.625	159	KL 11949		1.969 x 3.781	165	
KL 11906		2.375 x 2.625	159	KL 11950		1.750 x 2.250	164	
KL 11907		1.313 x 2.250	156	KL 11951 P		2.000 x 2.375	165	
KL 11908		2.250 x 2.500	159	KL 11952		2.375 x 2.250	166	
KL 11909		2.250 x 2.500	159	KL 11953 P		2.000 x 2.000	166	
KL 11910		1.532 x 2.250	157	KL 11954 P		1.280 x 2.242	163	
KL 11912P		1.750 x 2.609	159	KL 11956		2.250 x 3.634	166	
KL 11913		3.000 x 2.719	159	KL 11958		2.875 x 2.629	166	
KL 11915		1.375 x 2.625	160	KL 11960 P		3.131 x 3.961	167	
KL 11916P		1.208 x 2.250	160	KL 11961		1.750 x 2.500	166	
KL 11917P		1.063 x 2.250	160	KL 11962 P		3.500 x 3.000	167	
KL 11918P		2.312 x 2.625	160	KL 11963 P		1.481 x 2.625	165	
KL 11919P		3.625 x 3.750	161	KL 11964		3.125 x 2.875	167	
KL 11921 P		2.500 x 3.875	161	KL 11965		1.250 x 3.000	165	
KL 11922		1.531 x 3.516	162	KL 11966		2.808 x 2.653	166	
KL 11923		2.235 x 2.938	161	KL 11967		1.750 x 2.750	166	
KL 11924		1.640 x 2.625	161	KL 11968		1.281 x 2.527	165	
KL 11925P		1.500 x 5.000	161	KL 11969		1.625 x 3.000	167	
KL 11926P		1.750 x 2.500	162	KL 11970P		2.500 x 3.250	167	
KL 11927		1.019 x 1.734	159	KL 11971		.875 x 2.250	164	
KL 11928		2.250 x 2.750	162	KL 11972		1.893 x 2.632	168	
KL 11929		4.125 x 6.500	163					
KL 11930 P		1.500 x 1.750	160					
KL 11931 P		1.250 x 2.750	160					
KL 11932 P		1.593 x 1.750	160					

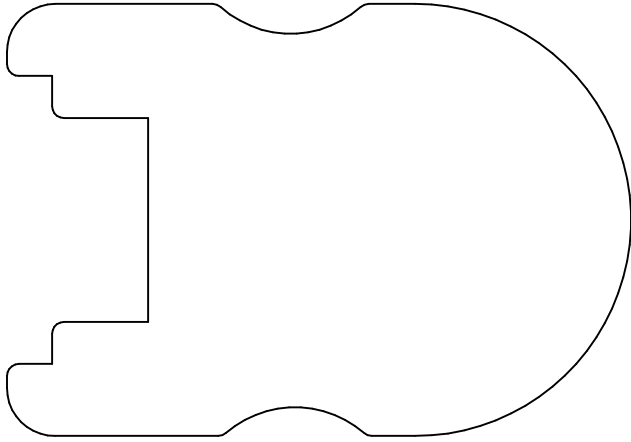

**KL 902P**  
3.250 x 2.250

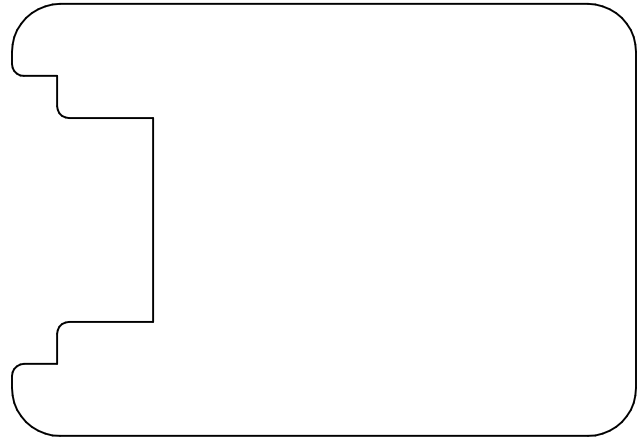

**KL 903P**  
3.250 x 2.250

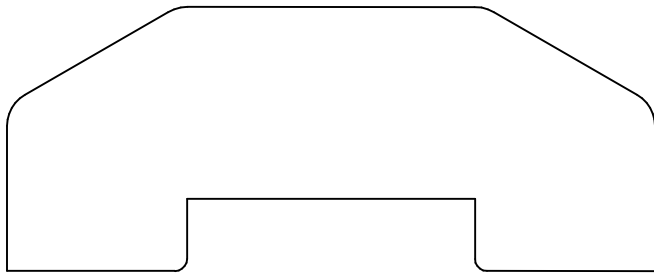

**KL 904P**  
1.375 x 3.375



**KL 905**  
.687 x 1.437

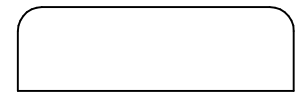

**KL 906**  
.437 x 1.437

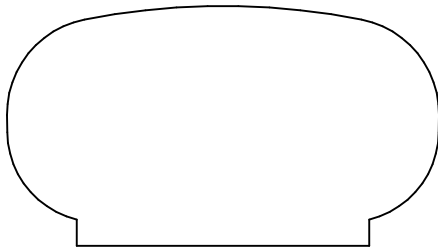

**KL 907**  
1.250 x 2.248

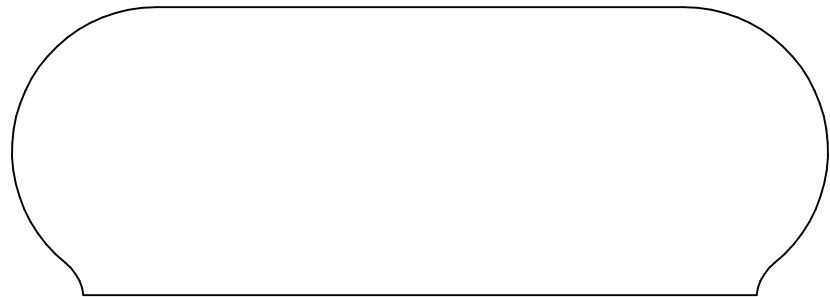

**KL 908**  
1.500 x 4.250

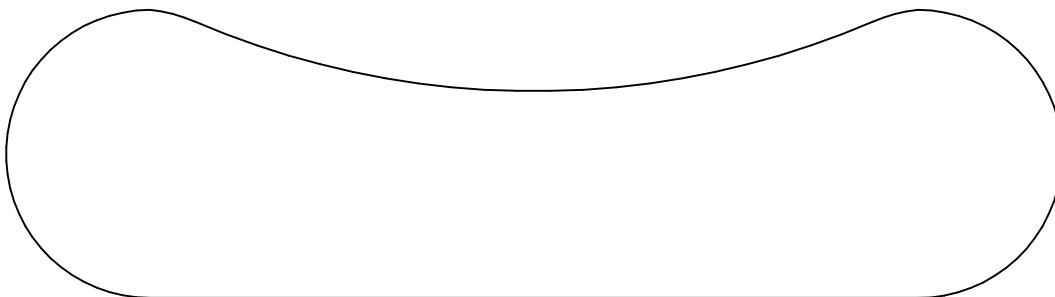

**KL 909**  
1.500 x 5.500

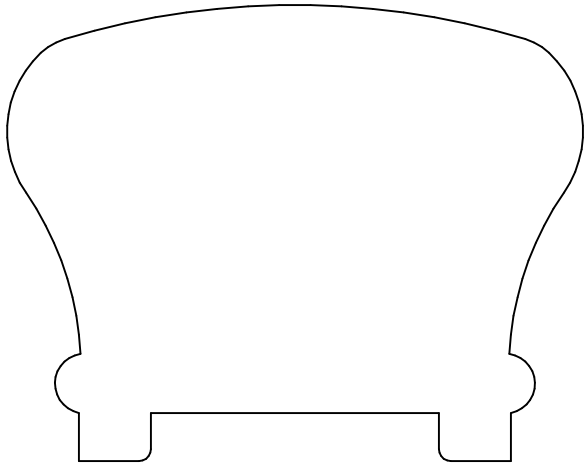

**KL 910P**  
2.375 x 2.994

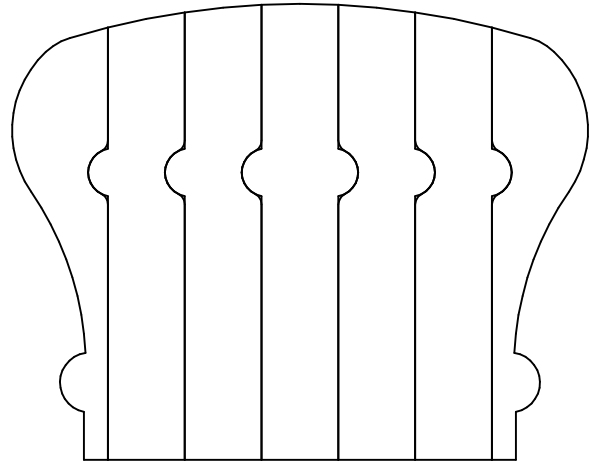

**KL 910B**  
2.375 x 3.000

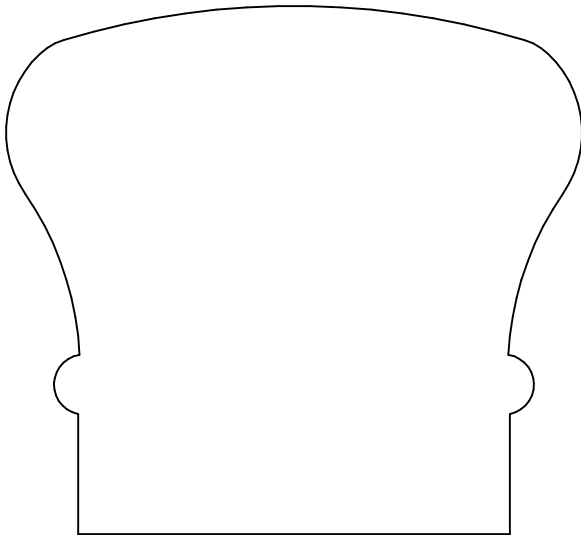

**KL 911**  
2.750 x 3.000

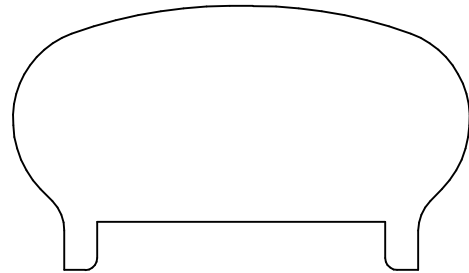

**KL 913P**  
1.375 x 2.378

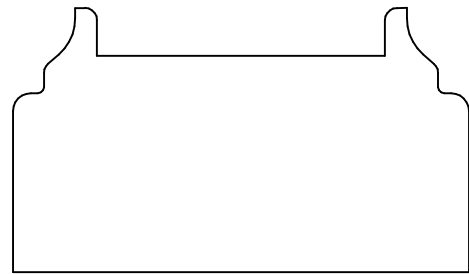

**KL 914P**  
1.375 x 2.375

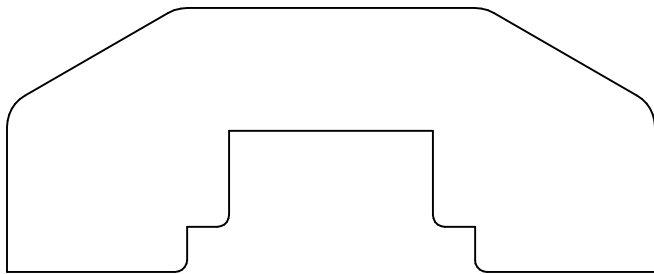

**KL 915P**  
1.375 x 3.375

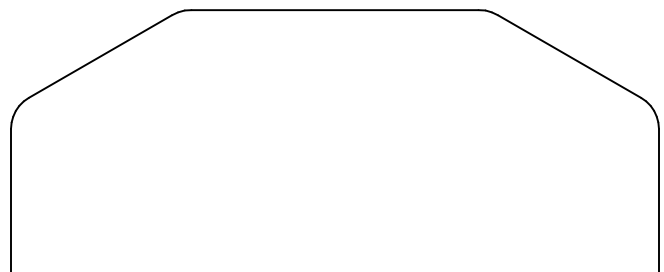

**KL 916**  
1.375 x 3.375

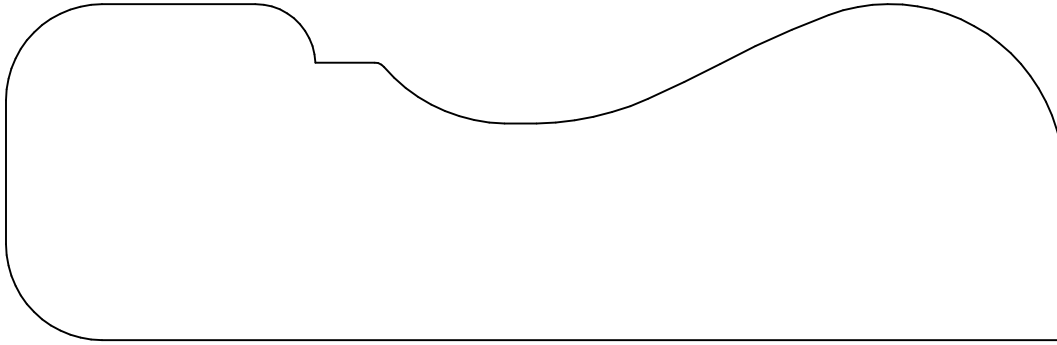

**KL 917**  
1.750 x 5.500

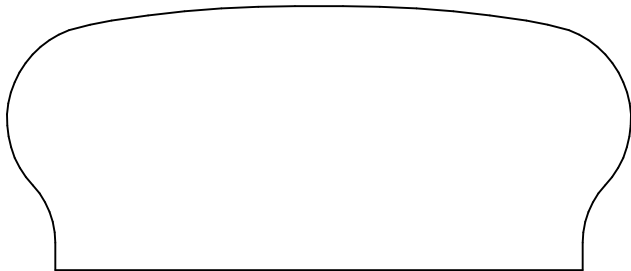

**KL 918**  
1.375 x 3.250

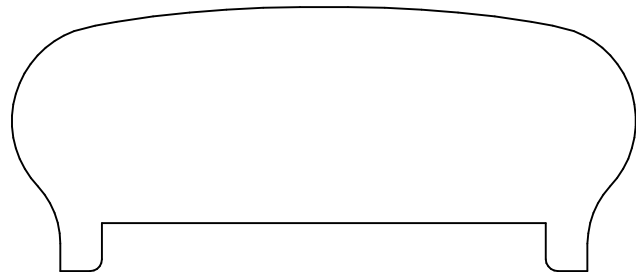

**KL 918P**  
1.375 x 3.250

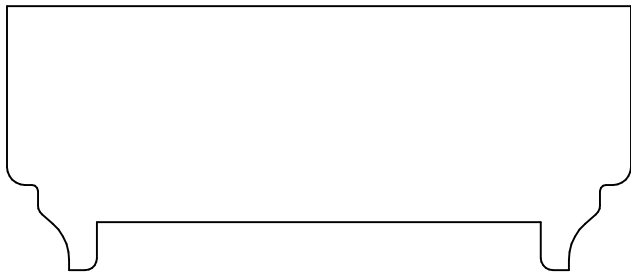

**KL 919P**  
1.375 x 3.250

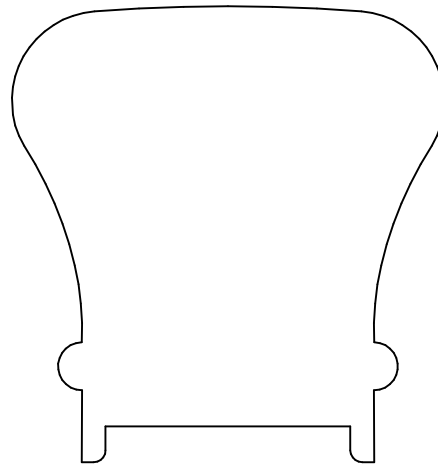

**KL 920P\_KLS 6010P**  
2.375 x 2.250

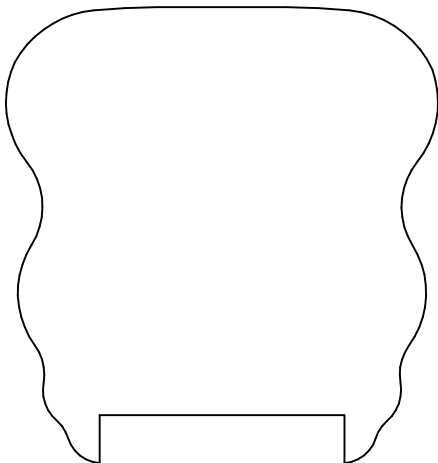

**KL 921P\_6112P**  
2.375 x 2.250



**KL 926**  
.437 x 2.250

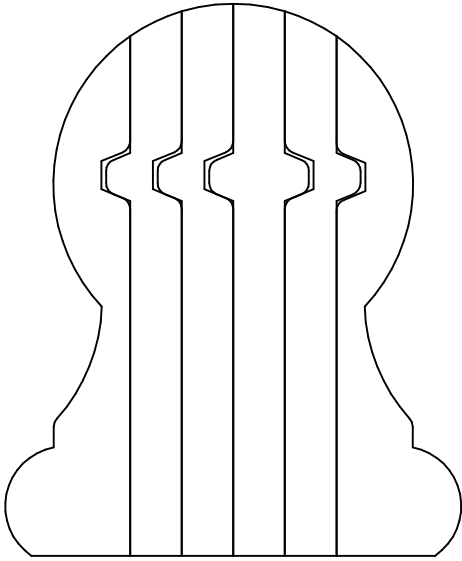

**KL 922 B**  
2.875 x 2.375

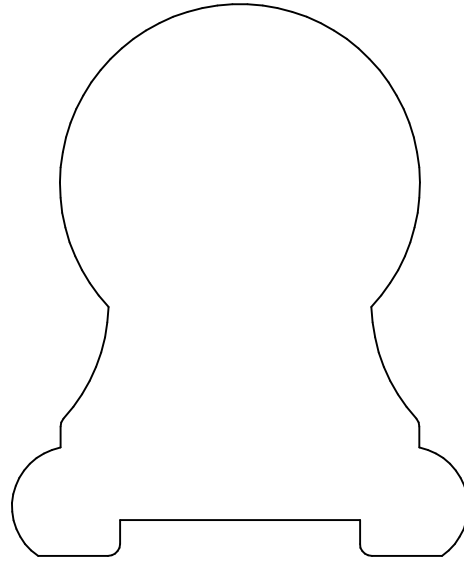

**KL 922PO\_6109P**  
2.875 x 2.375

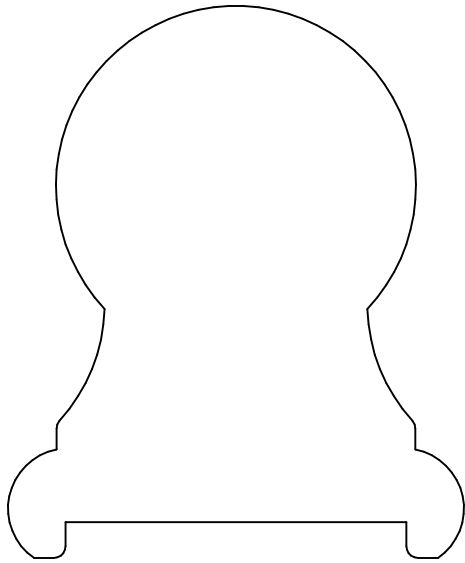

**KL 922P1\_6109P**  
2.875 x 2.375

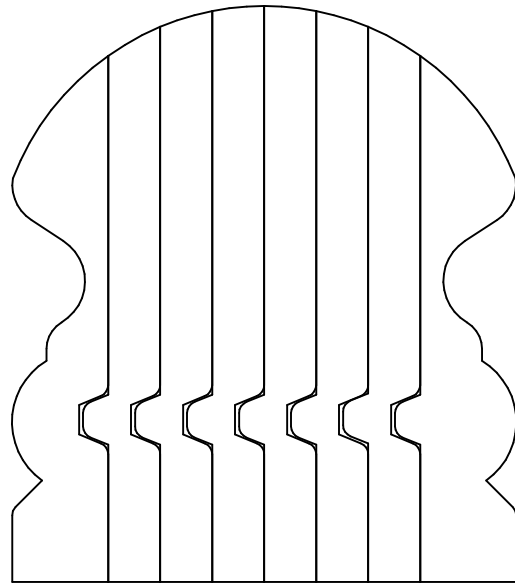

**KL 924B\_KLS 6519B**  
3.000 x 2.625

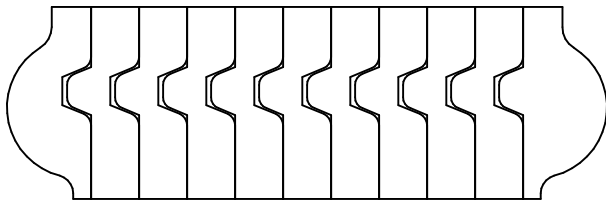

**KL 927B**  
1.000 x 3.125

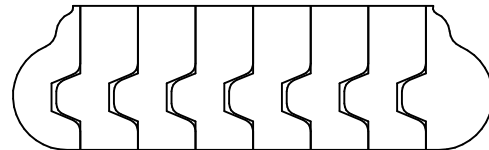

**KL 929B**  
.750 x 2.500

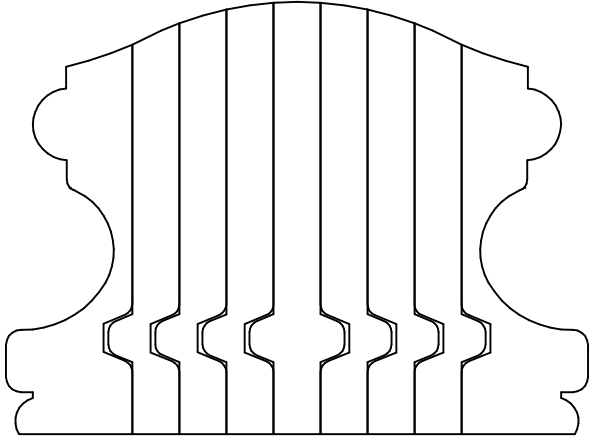

**KL 925B\_6400B**  
2.250 x 3.031

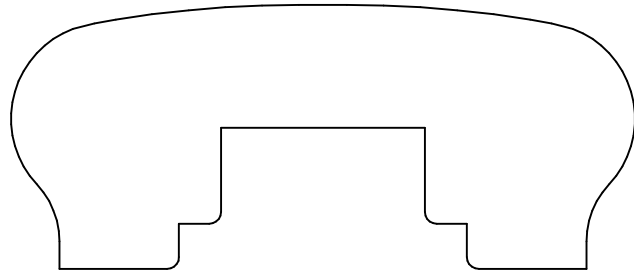

**KL 931P**  
1.375 x 3.250

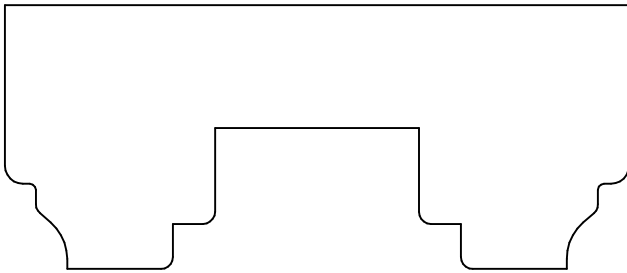

**KL 932P**  
1.375 x 3.250

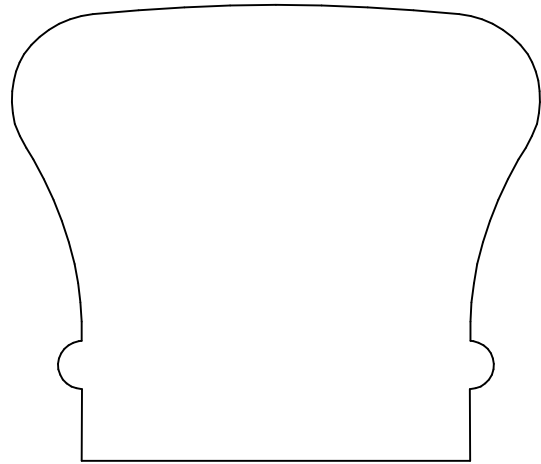

**KL 933**  
2.375 x 2.750

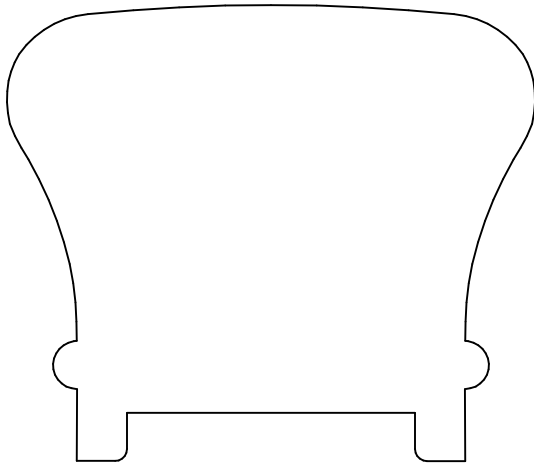

**KL 933P**  
2.375 x 2.750

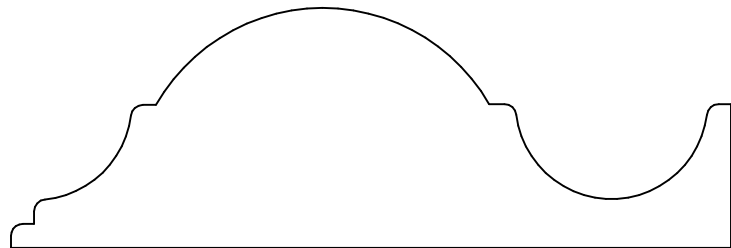

**KL 935**  
1.250 x 3.750

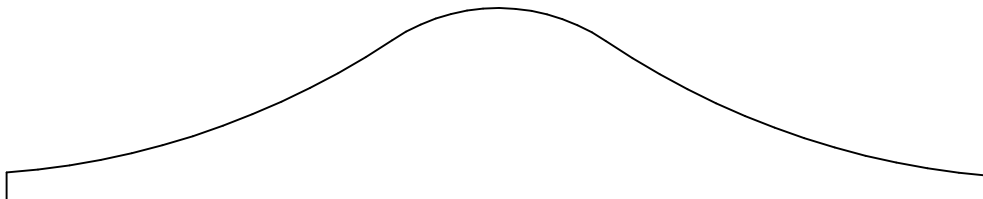

**KL 934A**  
1.000 x 5.125

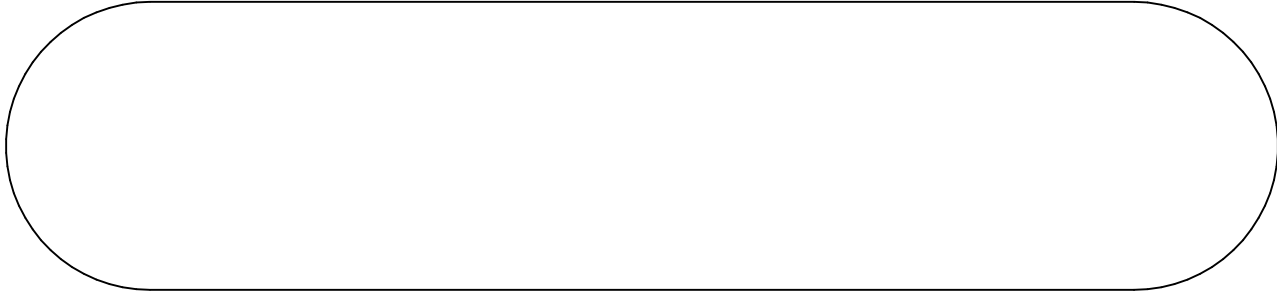

**KL 934B**  
1.500 x 6.625

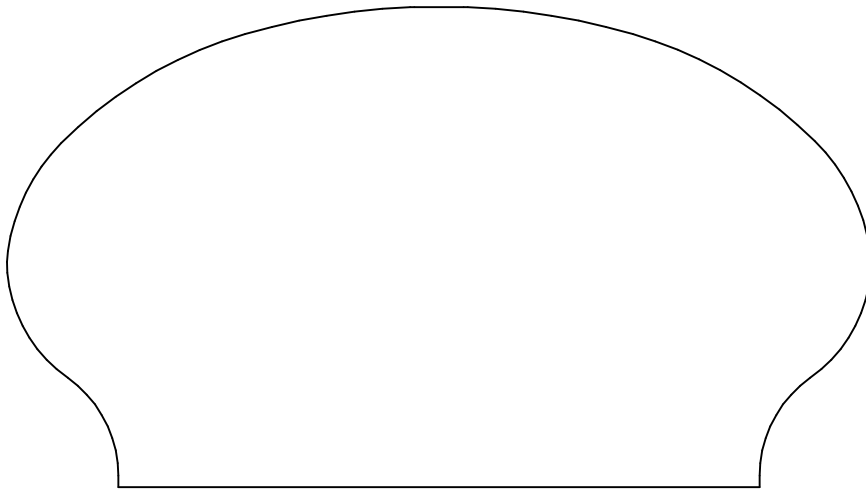

**KL 936**  
2.500 x 4.500

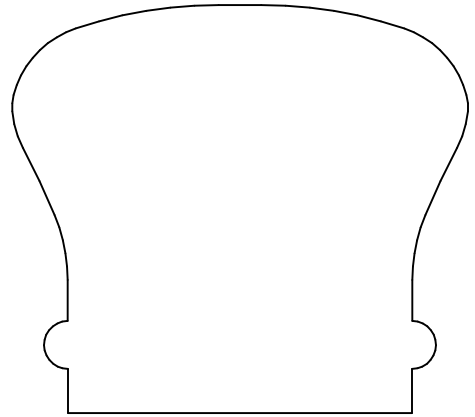

**KL 946**  
2.125 x 2.375

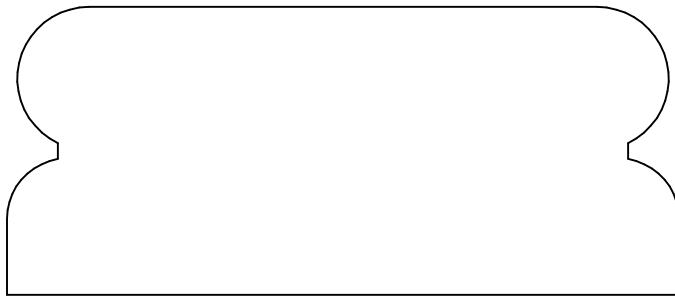

**KL 937**  
1.500 x 3.500

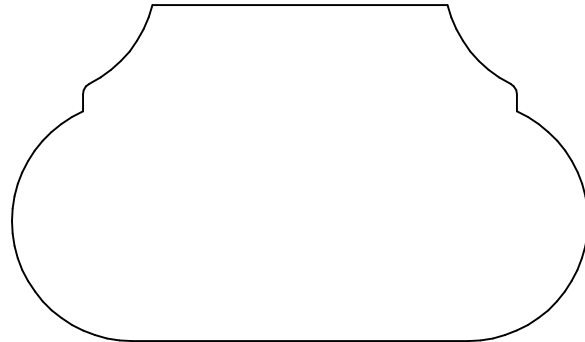

**KL 938**  
1.750 x 3.000

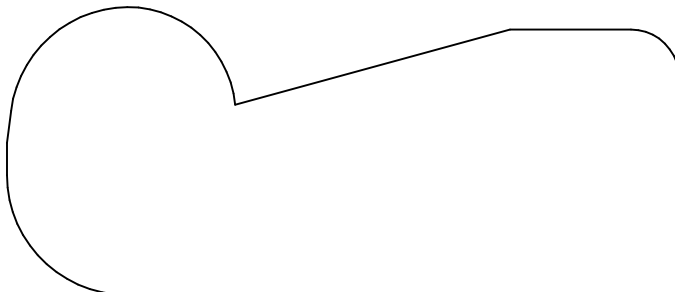

**KL 947**  
1.500 x 3.500

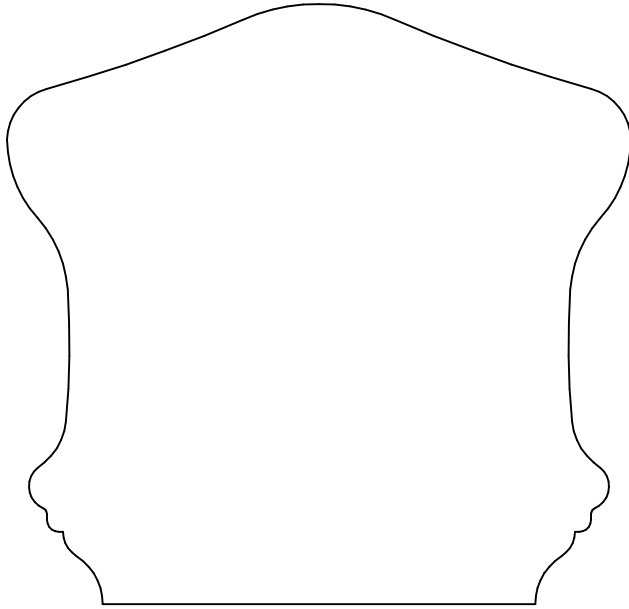

**KL 939**  
3.125 x 3.250

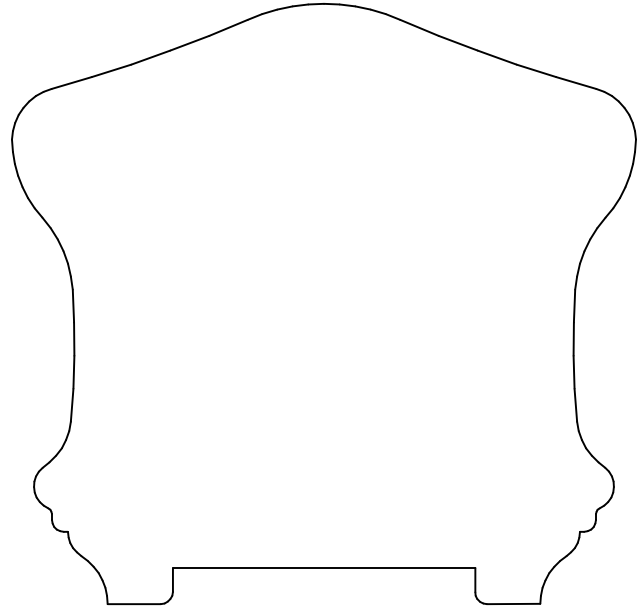

**KL 939P**  
3.125 x 3.250

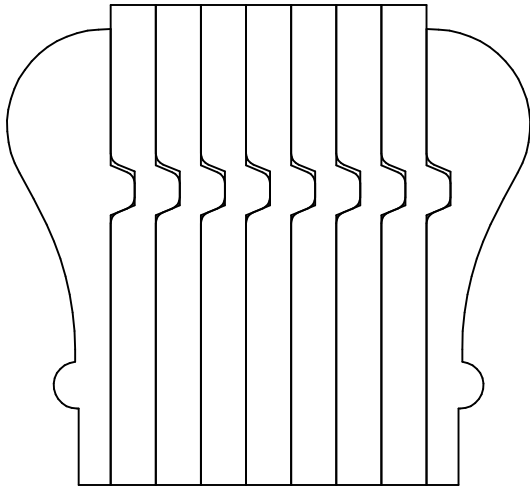

**KL 940B**  
2.500 x 2.725

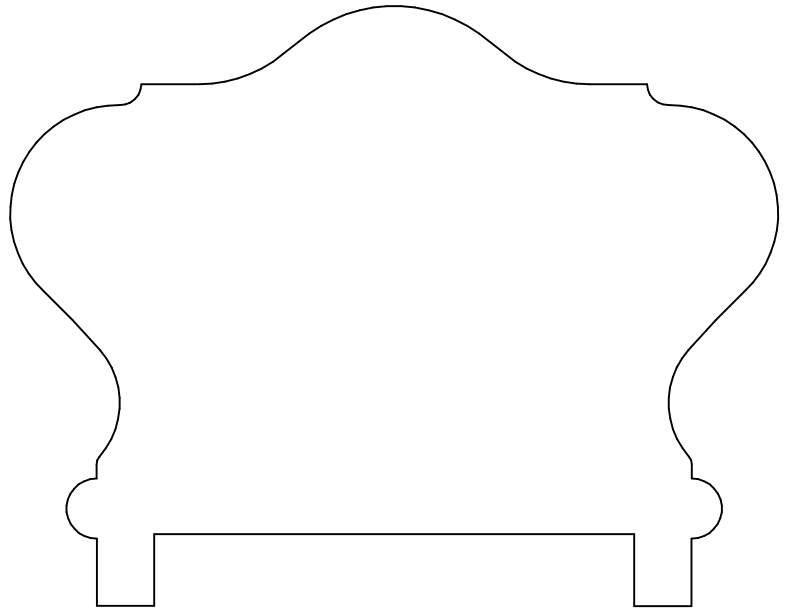

**KL 941P**  
3.125 x 4.000

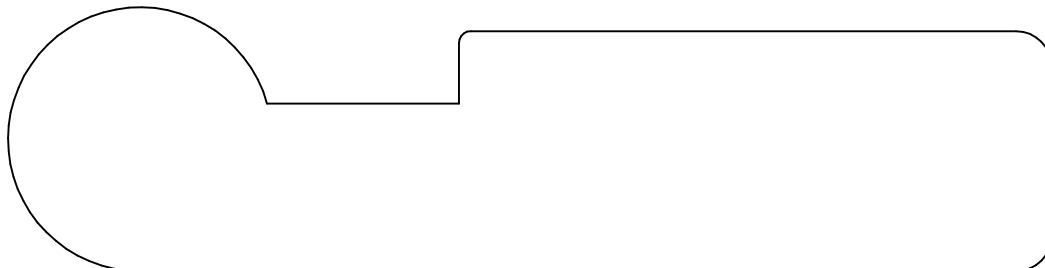

**KL 944**  
1.375 x 5.437



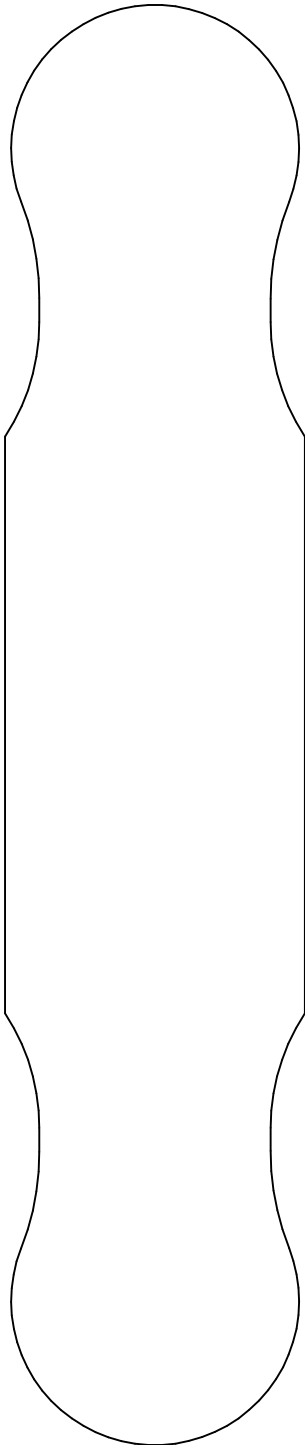

**KL 942**  
1.562 x 7.500



**KL 943**  
1.000 x 7.500

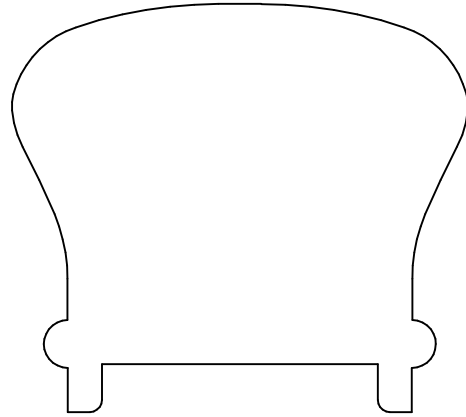

**KL 946P**  
2.125 x 2.375

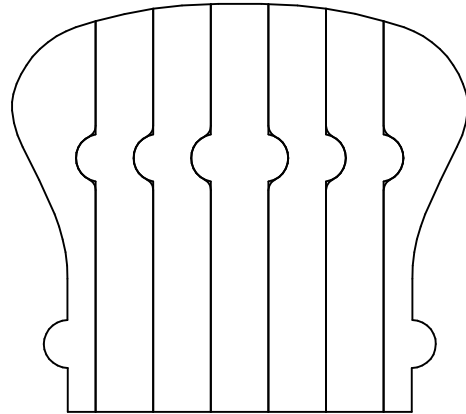

**KL 946B**  
2.125 x 2.375

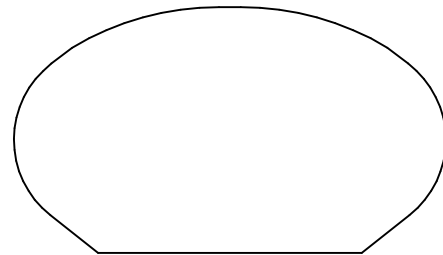

**KL 949\_6042**  
1.281 x 2.250

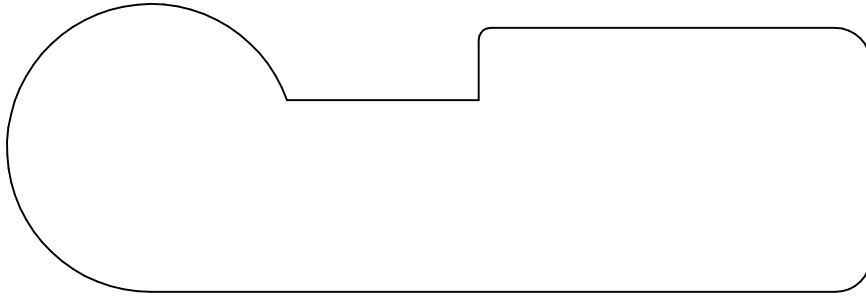

**KL 945**  
1.500 x 4.500

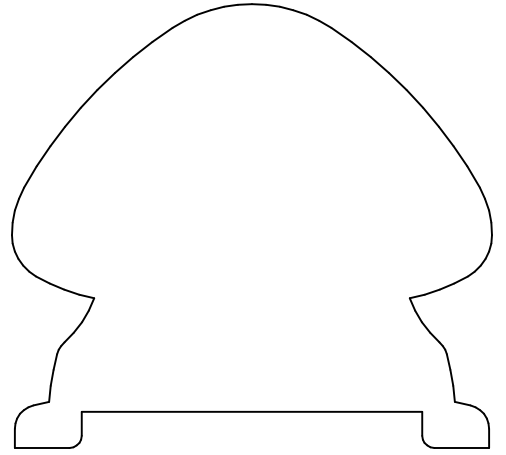

**KL 951P\_6005P**  
2.312 x 2.500

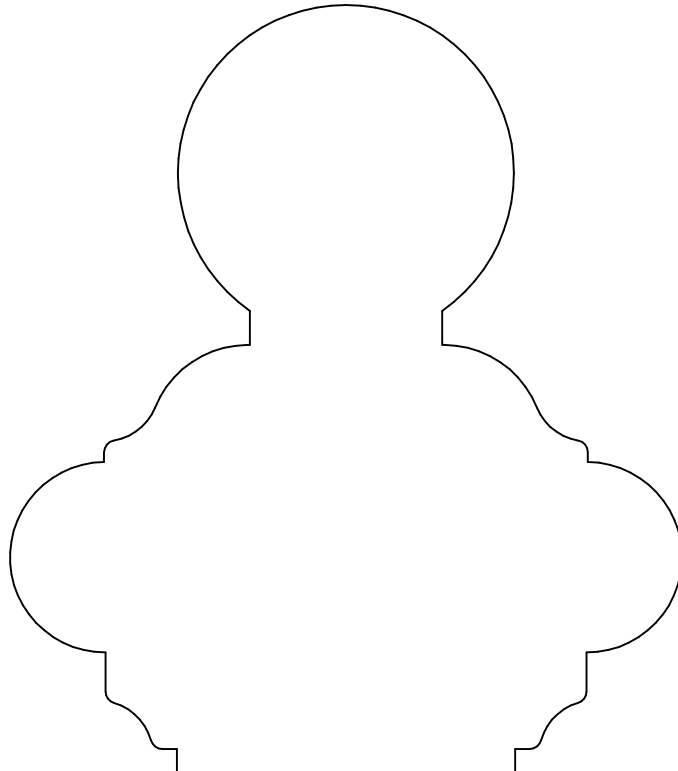

**KL 950**  
4.000 x 3.500

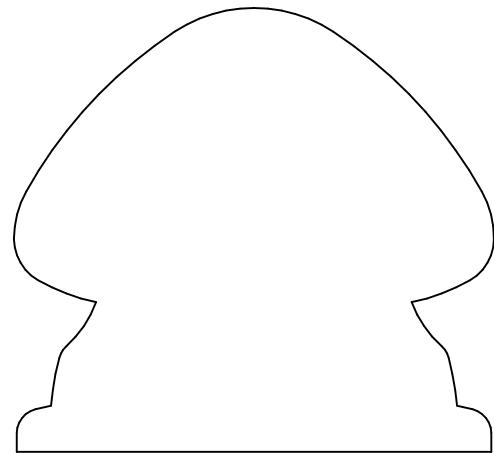

**KL 951\_6005**  
2.312 x 2.500

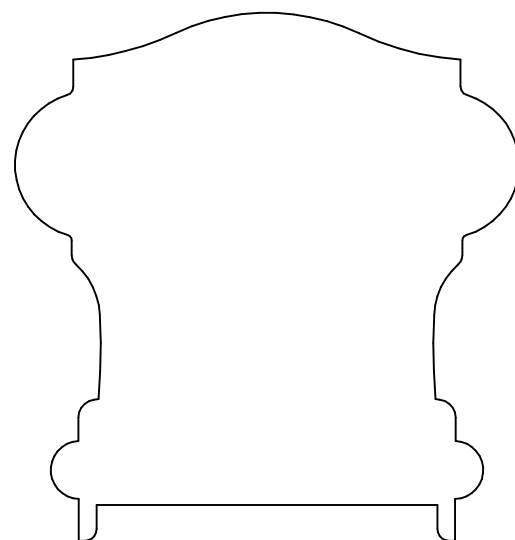

**KL 955P\_6900P**  
2.750 x 2.625

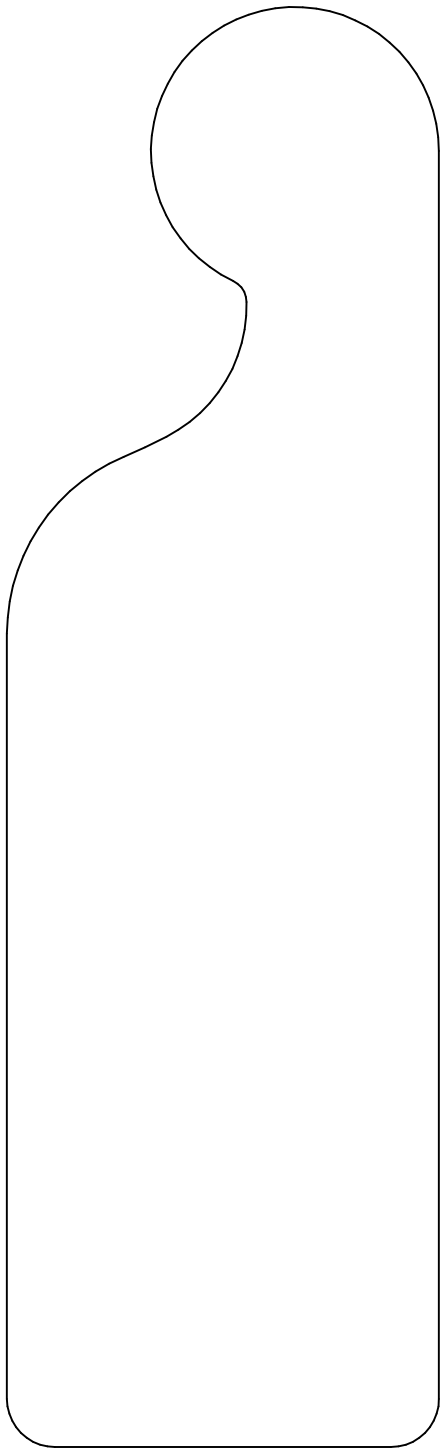

**KL 948**  
2.250 x 7.500

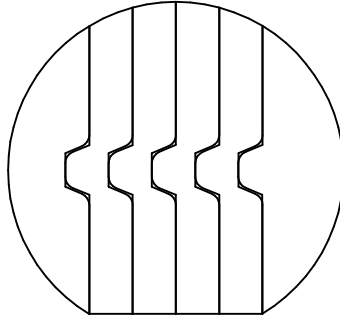

**KL 952B**  
1.625 x 1.749



**KL 971\_6000F**  
.375 x 1.250

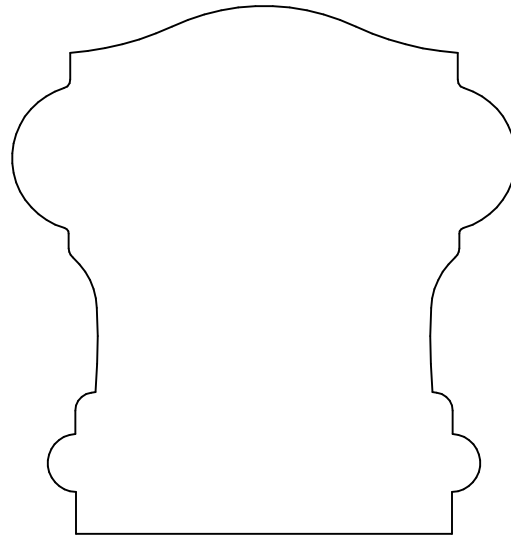

**KL 955\_6900**  
2.749 x 2.625



**KL 966P\_6001P**  
.750 x 2.500

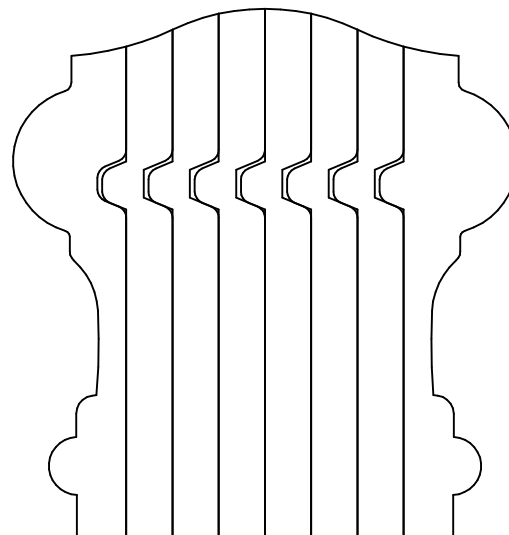

**KL 955B**  
2.750 x 2.625

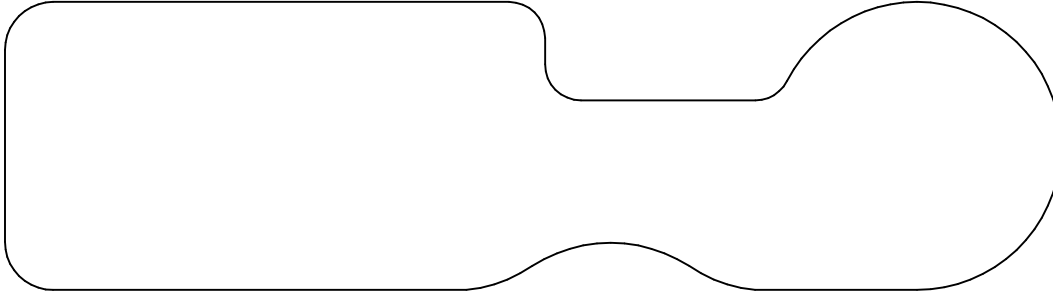

**KL 953**  
1.500 x 5.500

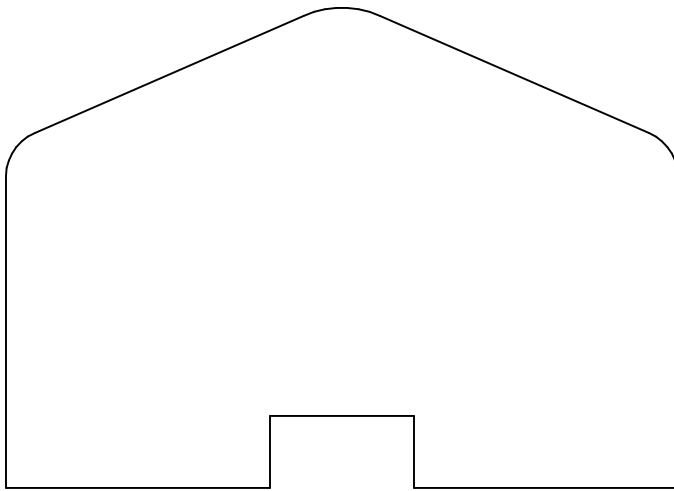

**KL 954P**  
2.500 x 3.500

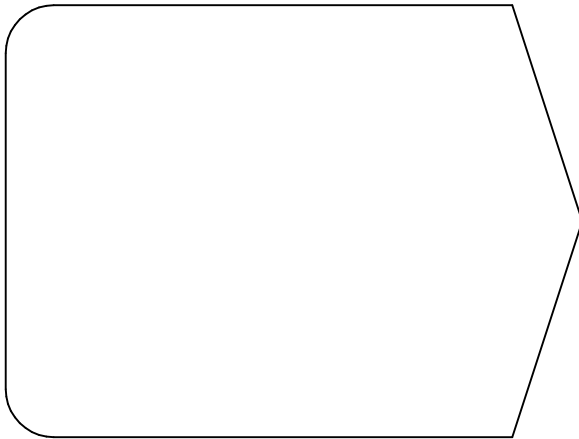

**KL 957**  
2.250 x 3.000



**KL 977**  
.500 x 1.000

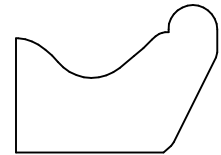

**KL 976**  
.768 x 1.049

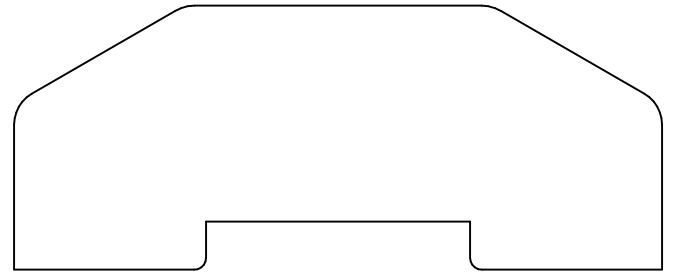

**KL 958P**  
1.375 x 3.375

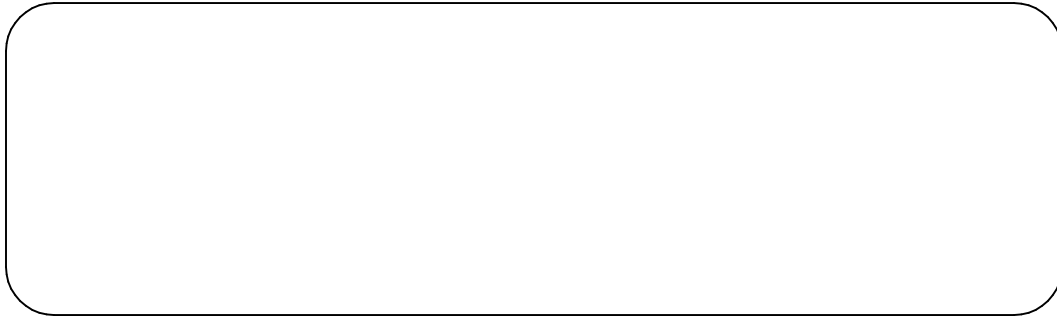

**KL 960\_6003**  
1.625 x 5.500

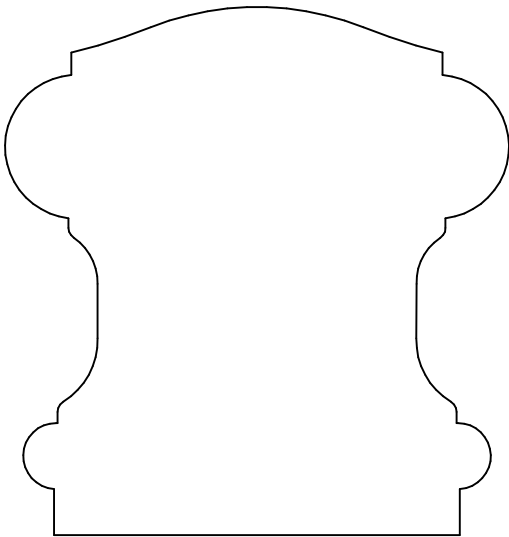

**KL 961\_6710**  
2.750 x 2.625

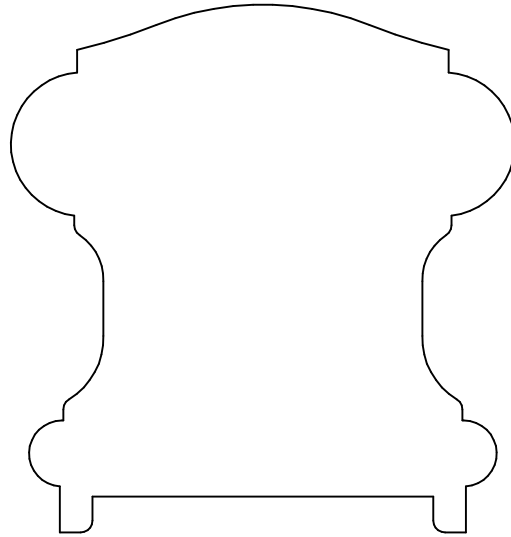

**KL 961P\_6710P**  
2.750 x 2.625

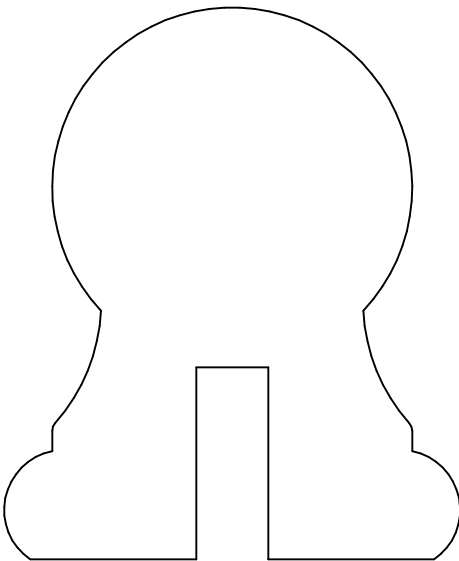

**KL 956\_6109G**  
2.875 x 2.375

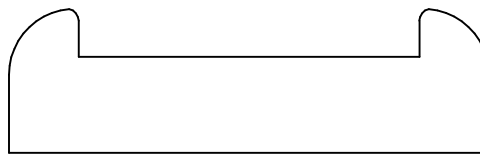

**KL 966P\_6001P**  
.750 x 2.500

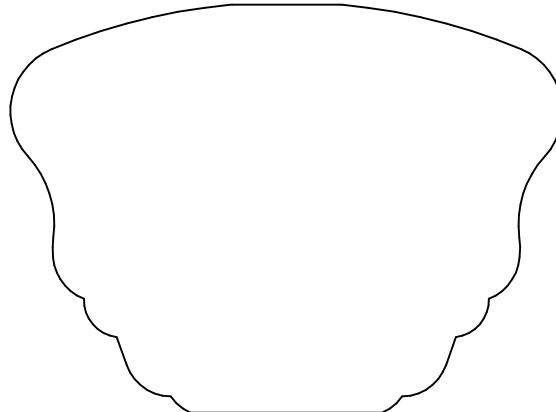

**KL 964**  
2.125 x 2.875

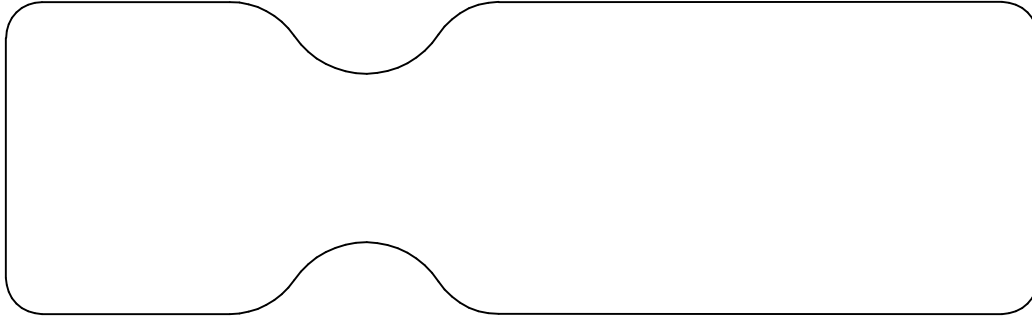

**KL 962\_6203**  
1.625 x 5.375

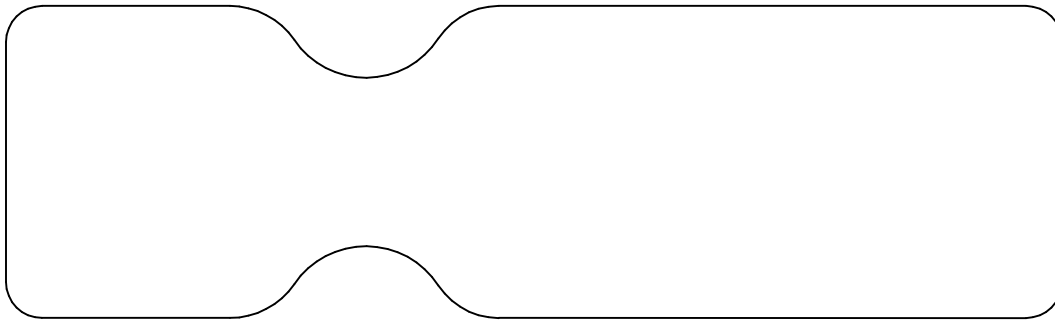

**KL 963\_6203**  
1.625 x 5.500

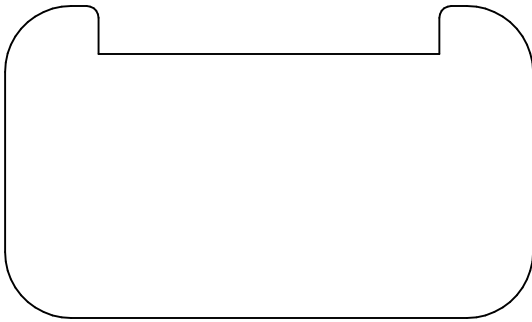

**KL 965P\_6001P**  
1.625 x 2.750

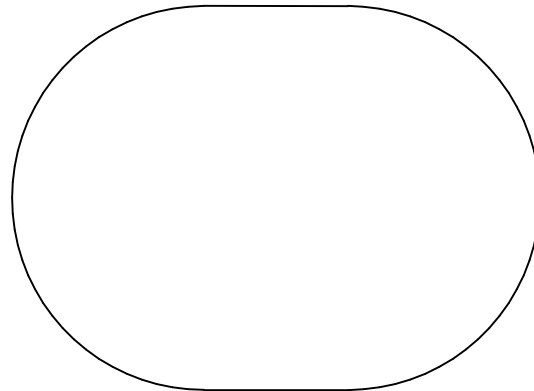

**KL 967**  
2.000 x 2.750

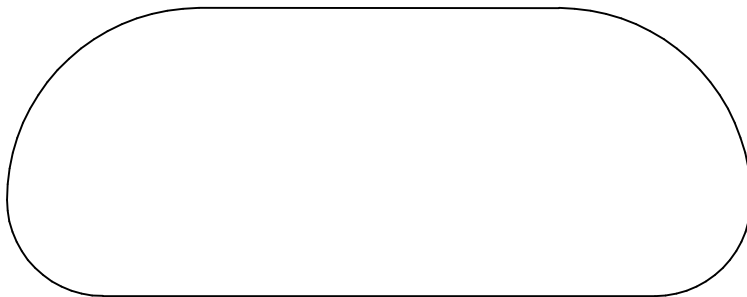

**KL 969**  
1.500 x 3.875

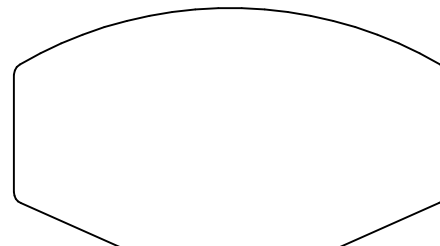

**KL 970**  
1.250 x 2.250

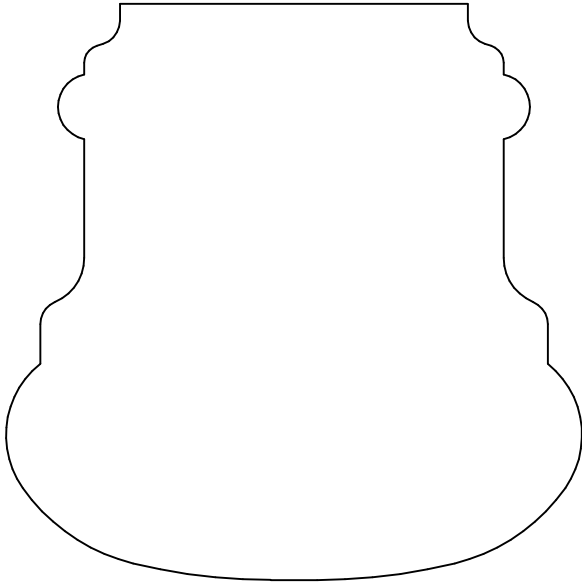

**KL 972**  
3.000 x 3.000

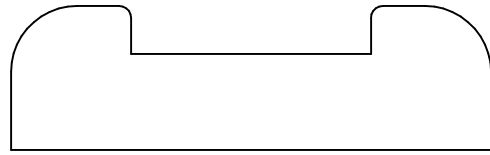

**KL 973P\_6000S**  
.750 x 2.500

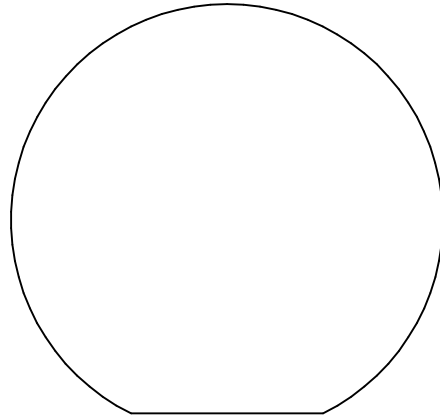

**KL 974**  
2.133 x 2.250

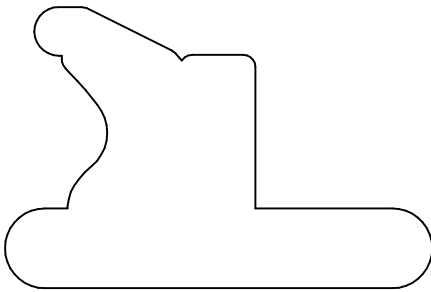

**KL 975**  
1.465 x 2.225

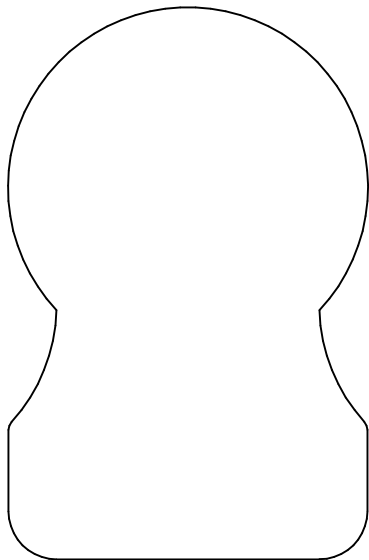

**KL 979**  
2.875 x 1.875

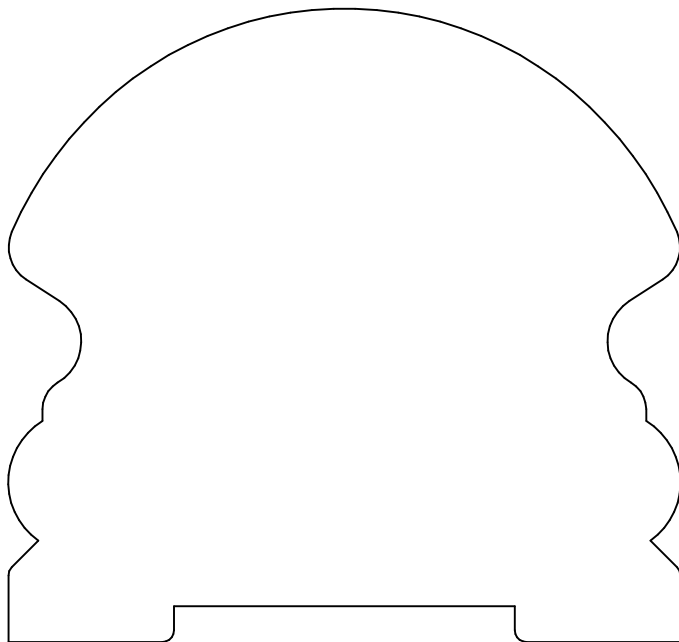

**KL 978P**  
3.300 x 3.502

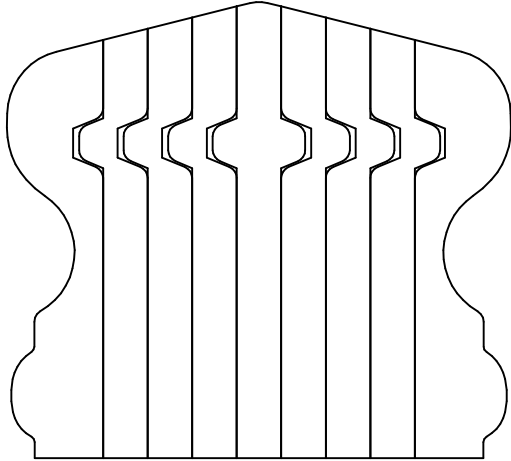

**KL 968B\_KLS 6910B**  
2.375 x 2.625

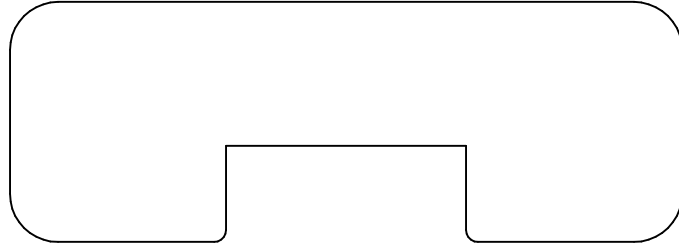

**KL 980P**  
1.250 x 3.500

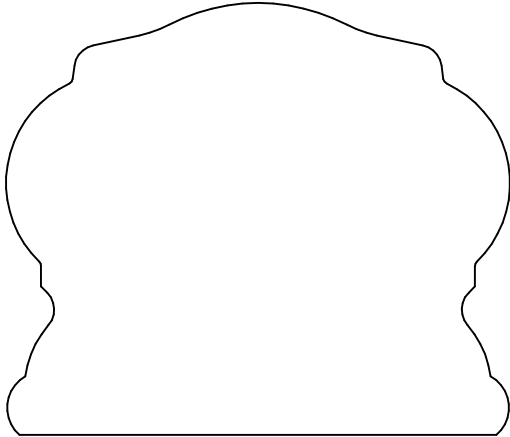

**KL 981\_6810**  
2.250 x 2.625

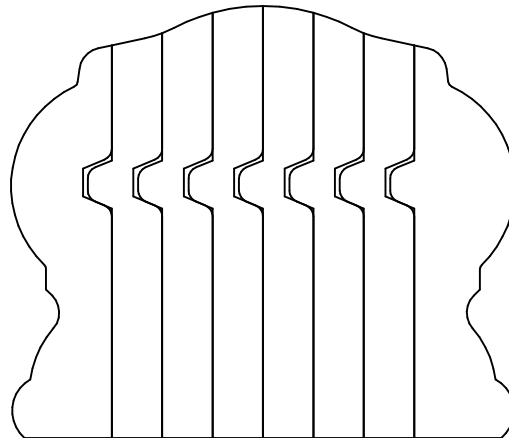

**KL 981B\_6810B**  
2.250 x 2.625



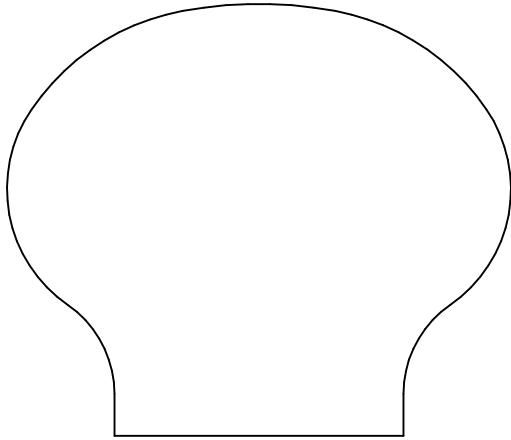

**KL 982\_6600**  
2.250 x 2.625

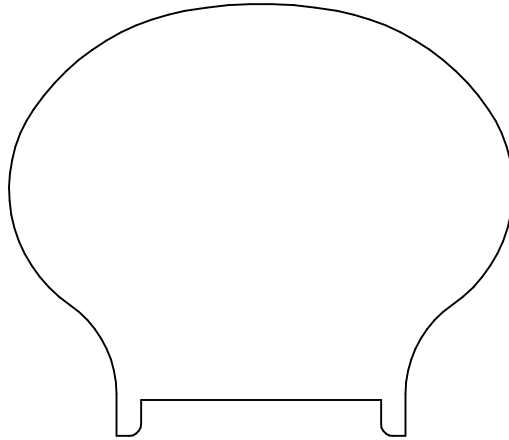

**KL 982P\_6600P**  
2.250 x 2.625

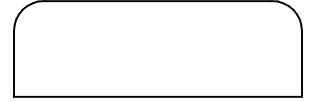

**KL 993**  
.500 x 1.500

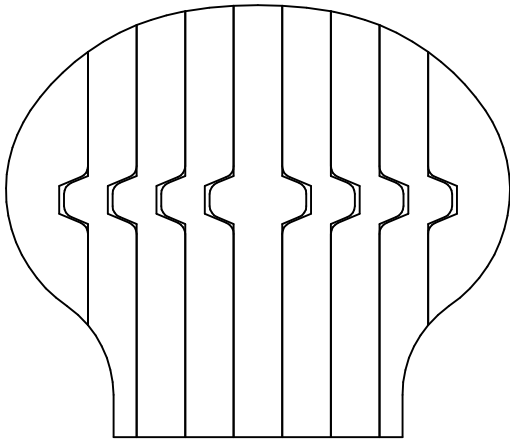

**KL 982B\_6600B**  
2.250 x 2.625

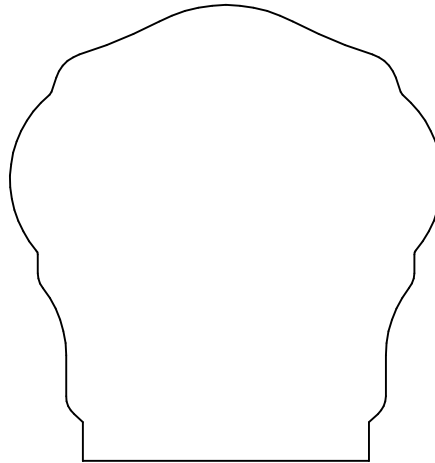

**KL 983**  
2.375 x 2.250

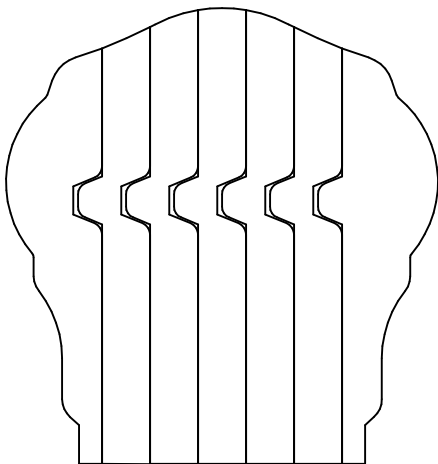

**KL 983B**  
2.375 x 2.250

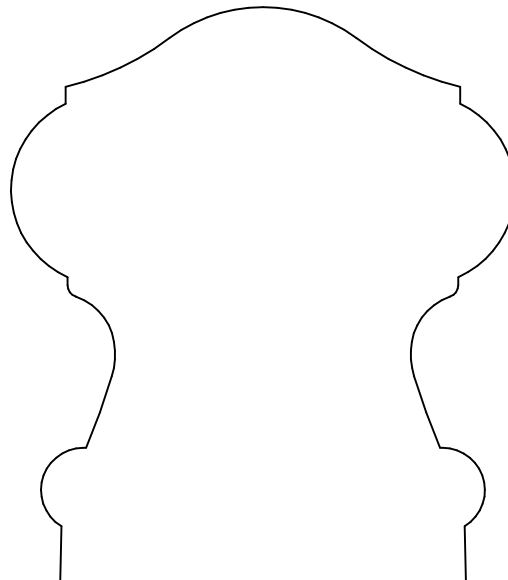

**KL 984**  
3.000 x 2.625

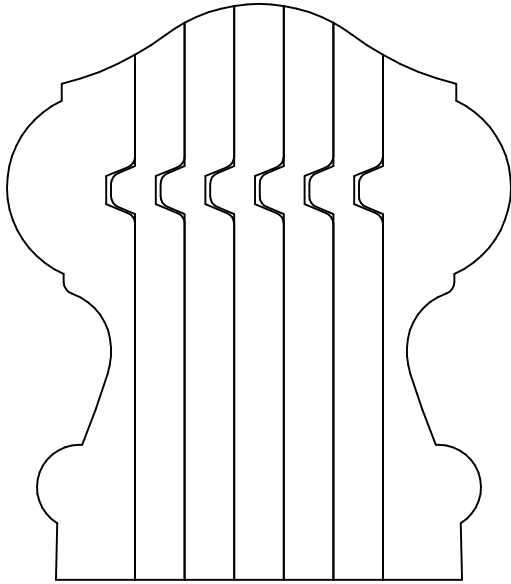

**KL 984B**  
3.000 x 2.625

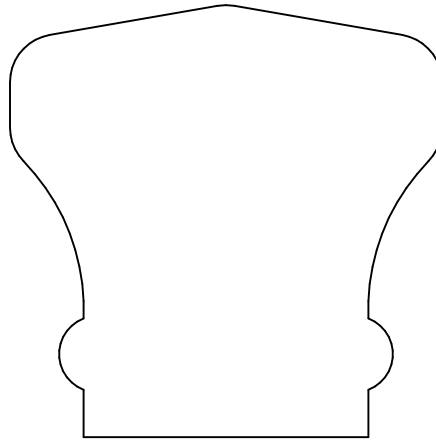

**KL 985\_6601**  
2.250 x 2.250

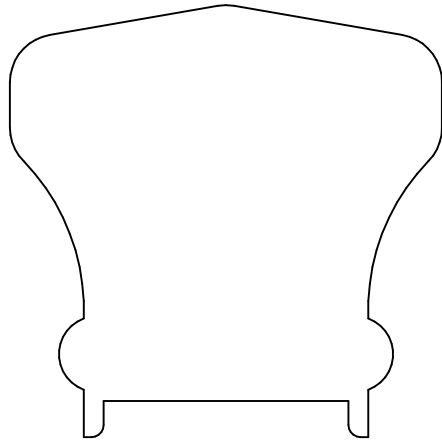

**KL 985P\_6601P**  
2.250 x 2.250

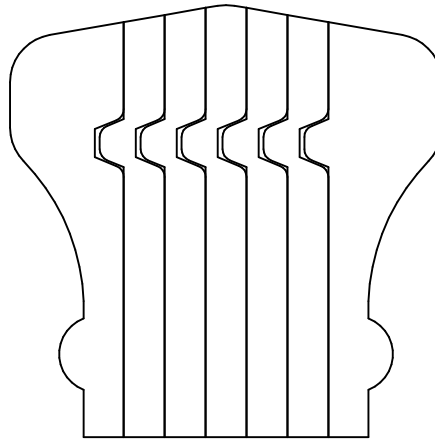

**KL 985B\_6601B**  
2.250 x 2.250

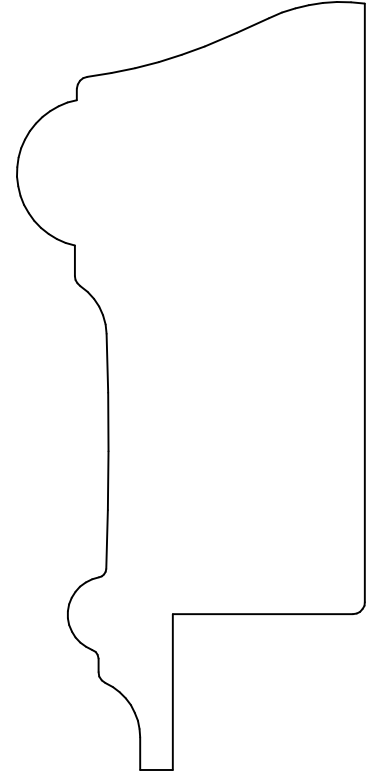

**KL 996**  
4.000 x 1.812

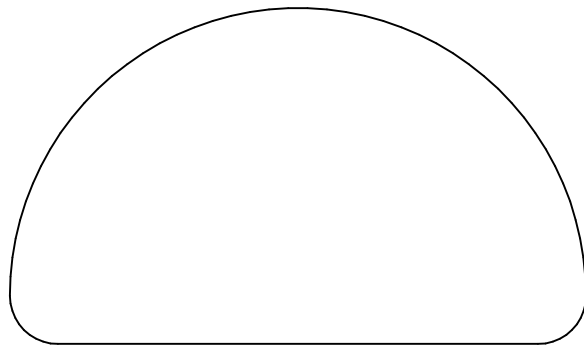

**KL 986**  
1.750 x 3.000

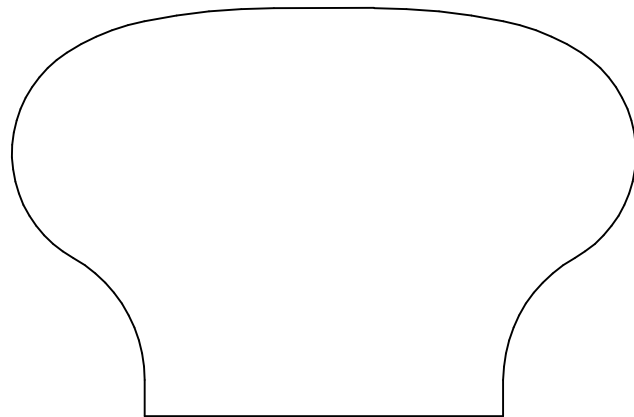

**KL 987**  
2.125 x 3.250

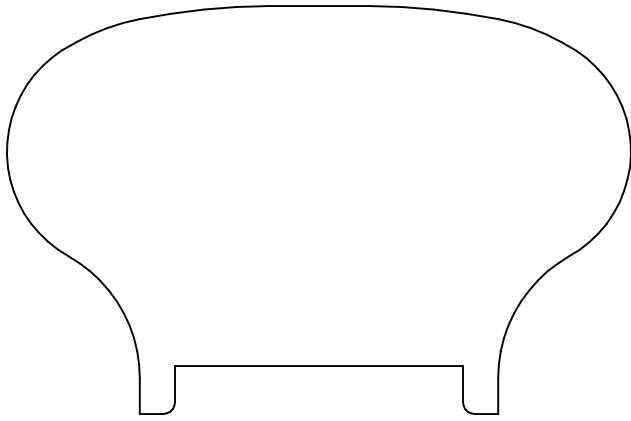

**KL 987P**  
2.125 x 3.250

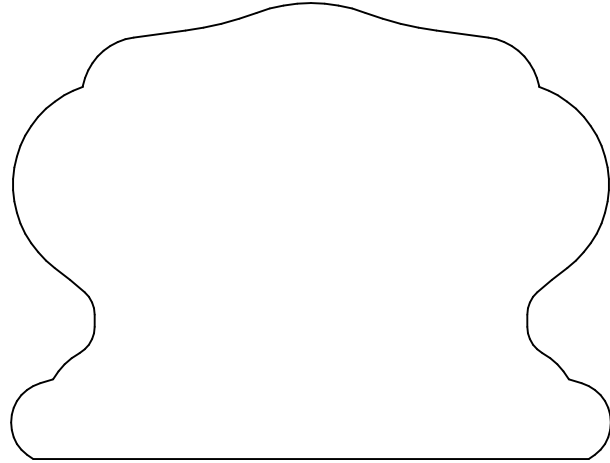

**KL 988**  
2.375 x 3.125

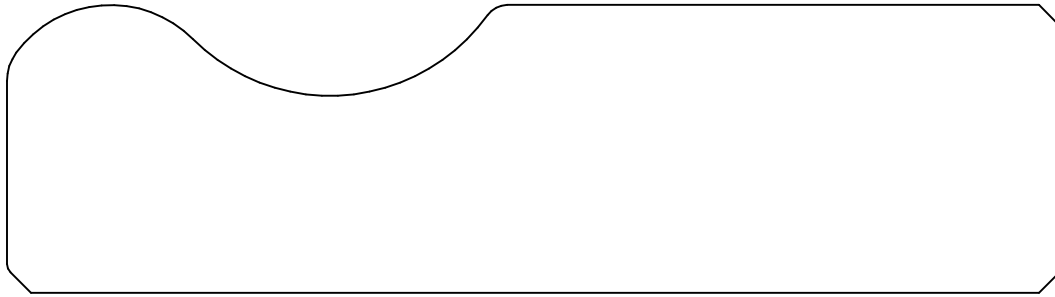

**KL 989**  
1.500 x 5.500

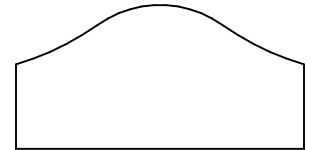

**KL 1903**  
.750 x 1.500

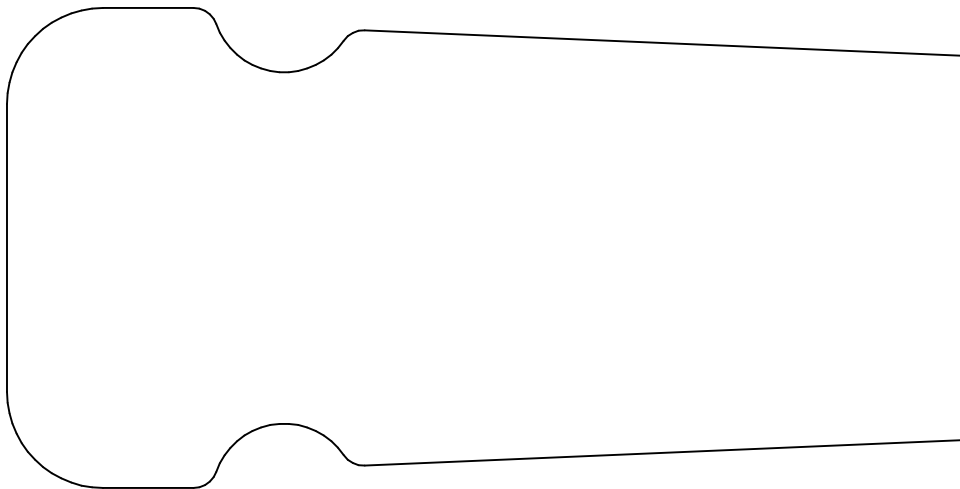

**KL 990**  
5.000 x 2.500

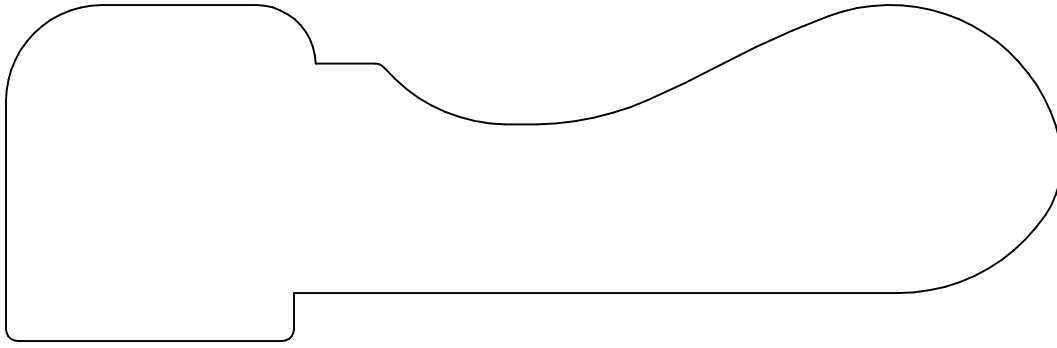

**KL 991**  
1.750 x 5.500

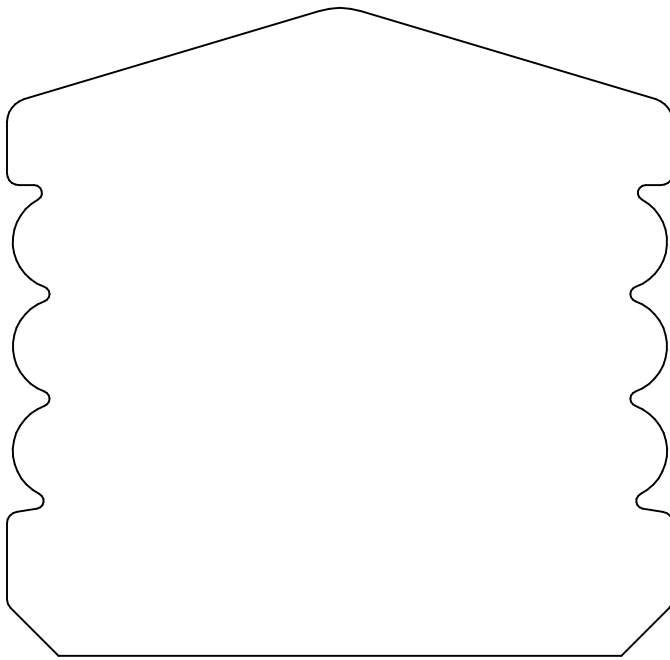

**KL 992**  
3.375 x 3.468

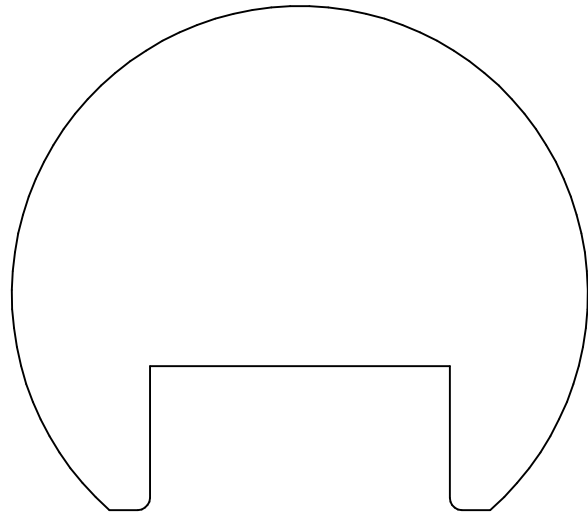

**KL 997P**  
2.625 x 3.000

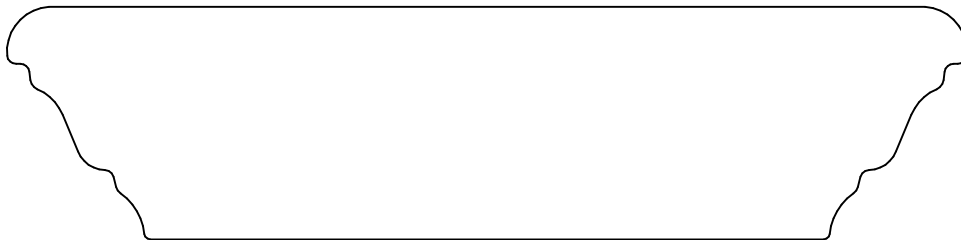

**KL 994**  
1.210 x 5.000

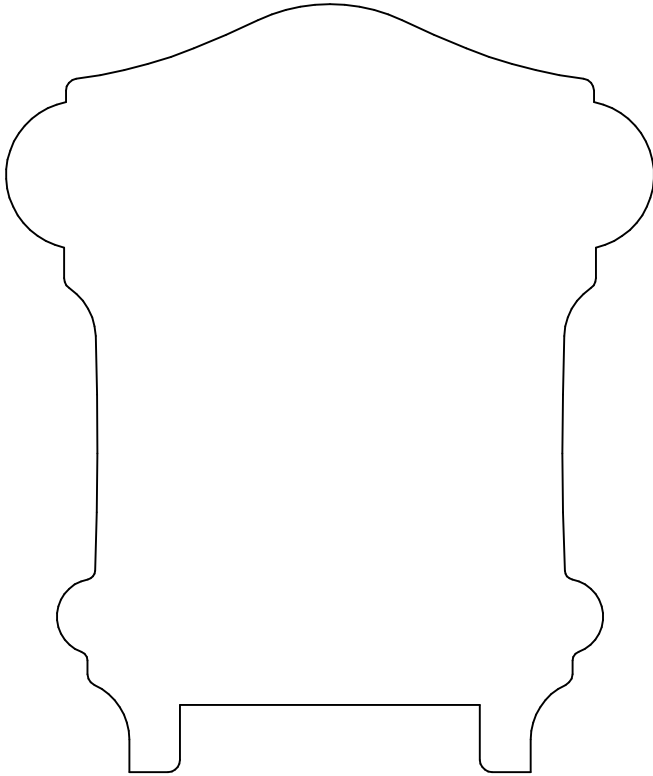

**KL 995P**  
4.000 x 3.375

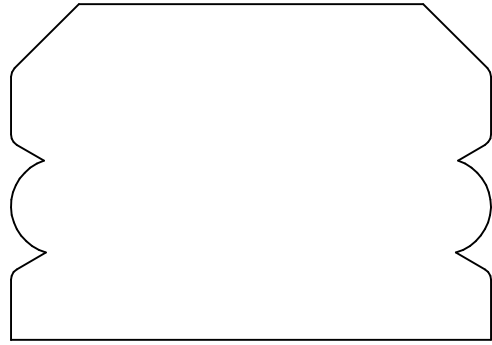

**KL 998**  
1.750 x 2.500

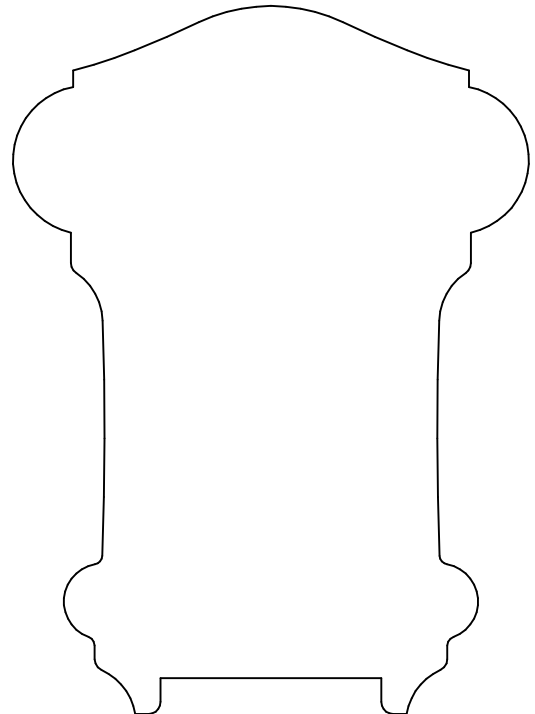

**KL 1900P**  
3.687 x 2.687

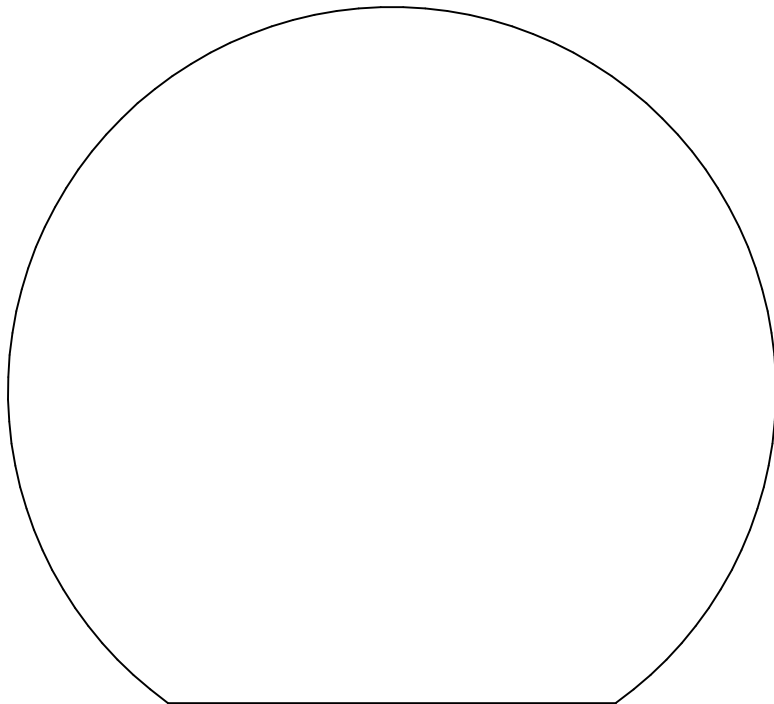

**KL 999**  
3.625 x 4.000

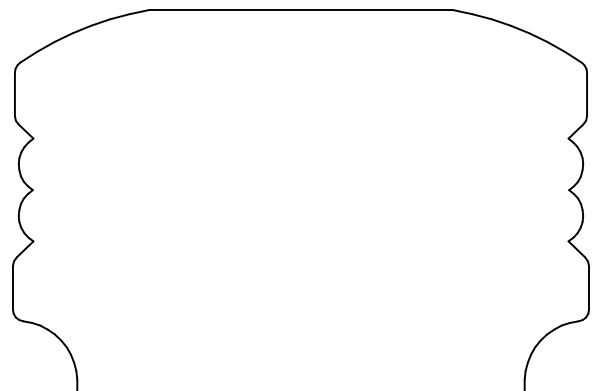

**KL 1901**  
2.000 x 3.000

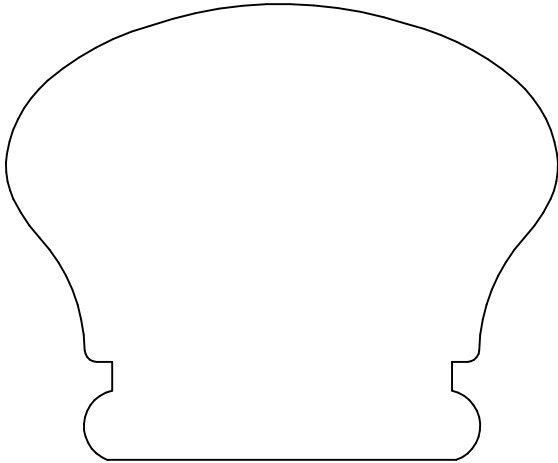

**KL 1902**  
2.375 x 2.875

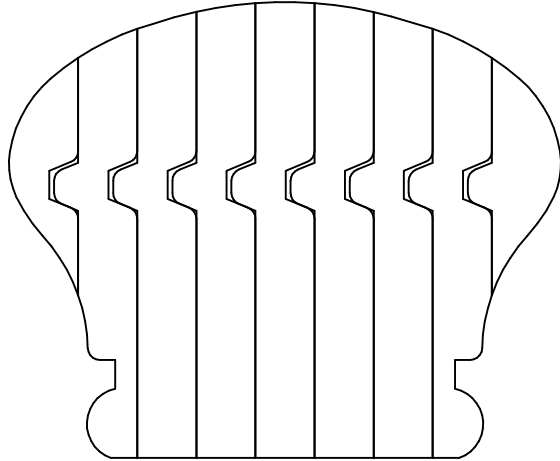

**KL 1902B**  
2.375 x 2.875

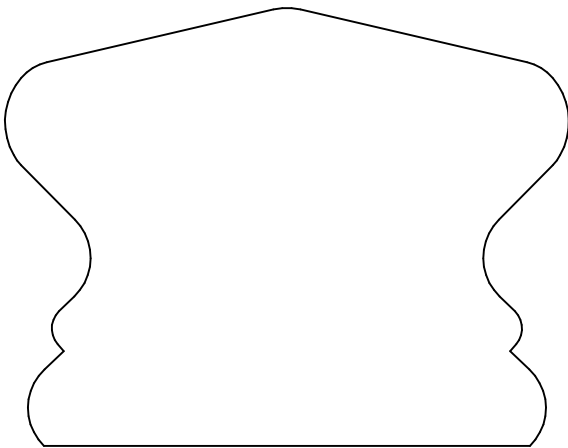

**KL 1904**  
2.281 x 2.937

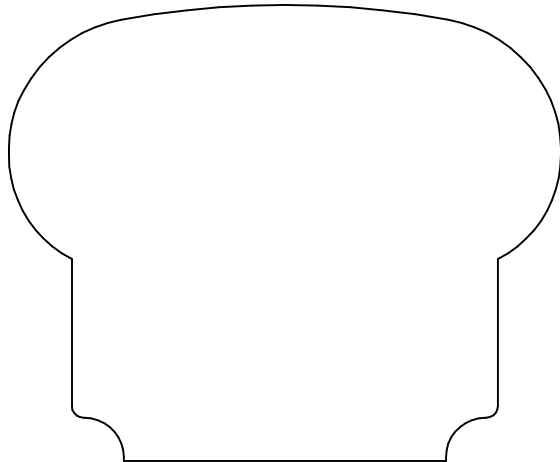

**KL 1905**  
2.375 x 2.875

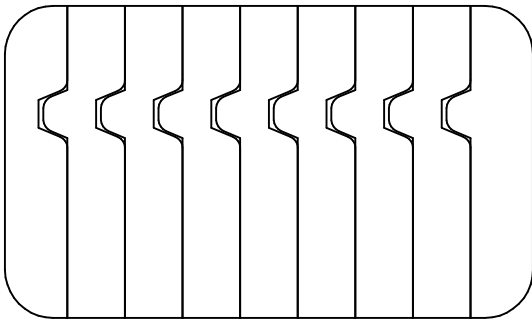

**KL 1906B**  
1.625 x 2.750



**KL 1906\_6002**  
1.625 x 2.750



**KL 1913**  
.687 x 1.437

# CUSTOM PROFILES

# Handrail

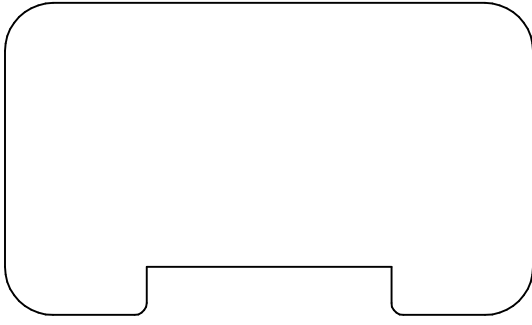

**KL 1906P**  
1.625 x 2.750

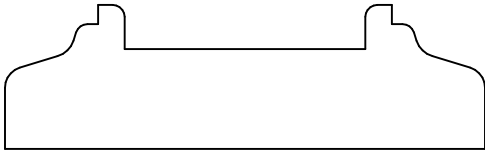

**KL 1910P**  
.750 x 2.500

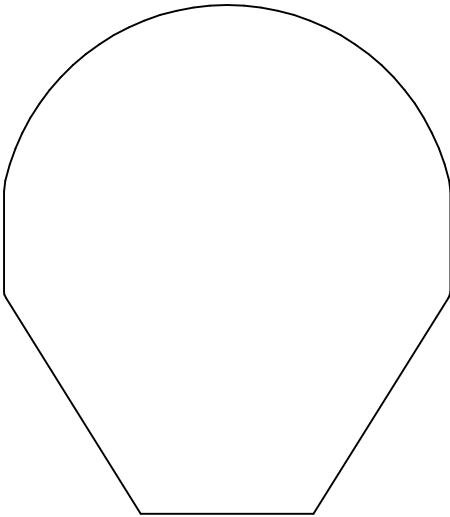

**KL 1918**  
2.650 x 2.325

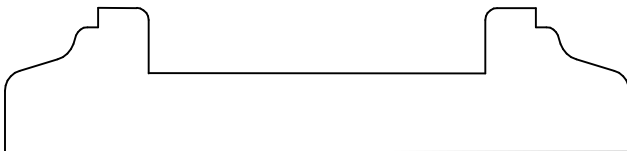

**KL 1908P**  
.750 x 3.250

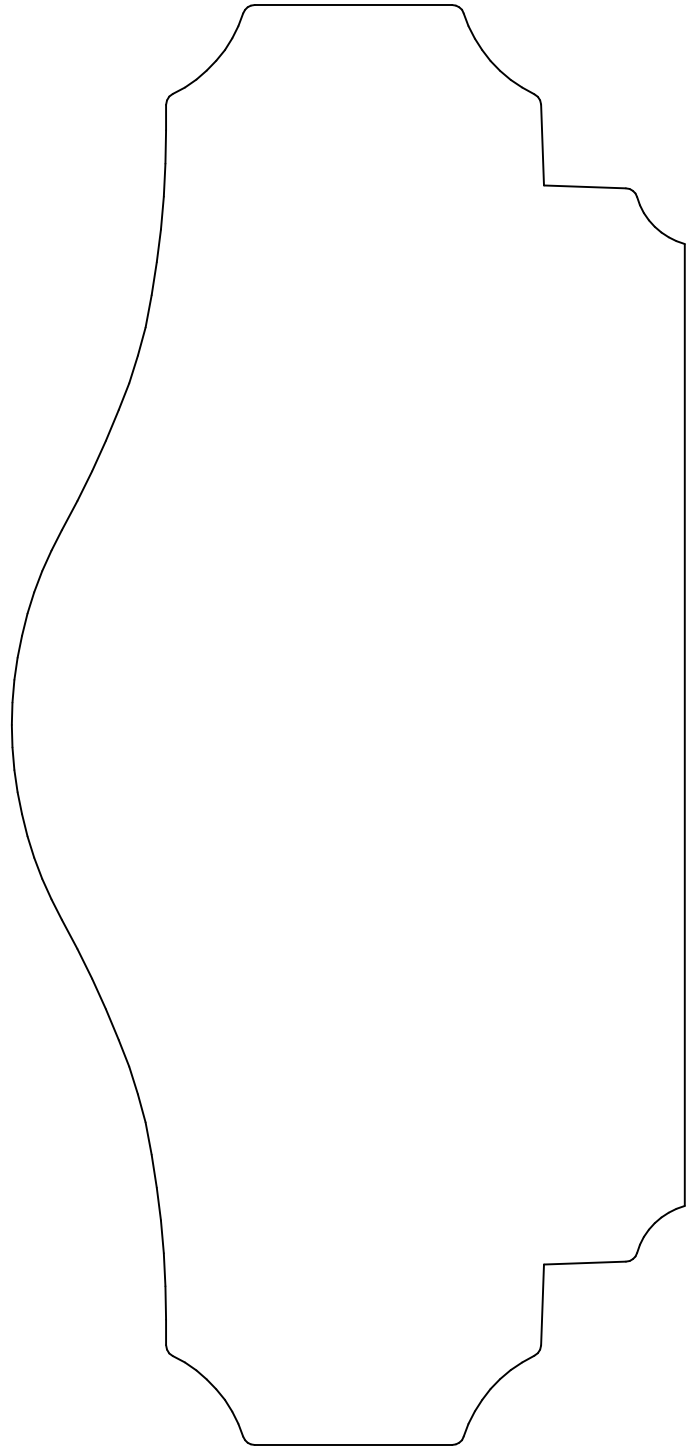

**KL 1907**  
3.504 x 7.500

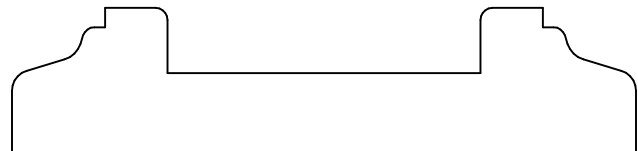

**KL 1909P**  
.750 x 3.250

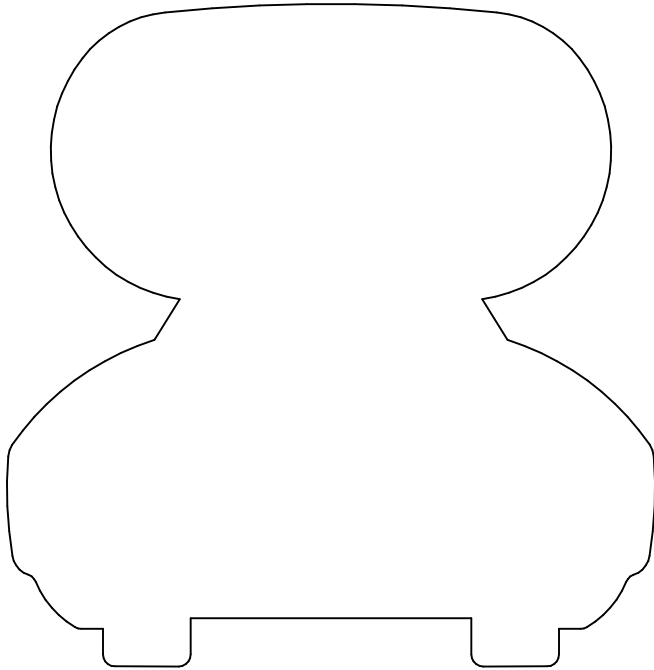

**KL 1911P**  
3.450 x 3.375

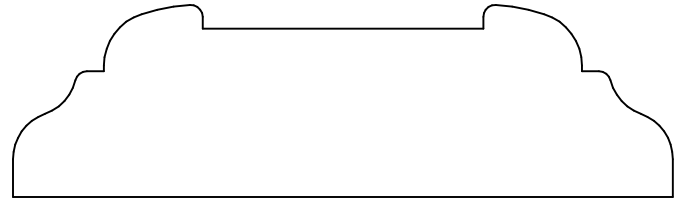

**KL 1912P**  
1.000 x 3.437

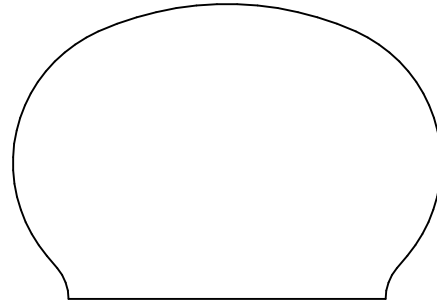

**KL 1923A**  
1.537 x 2.230

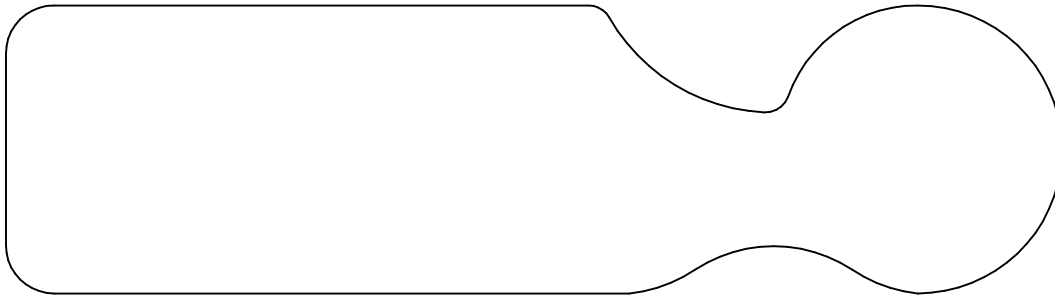

**KL 1916**  
1.500 x 5.500

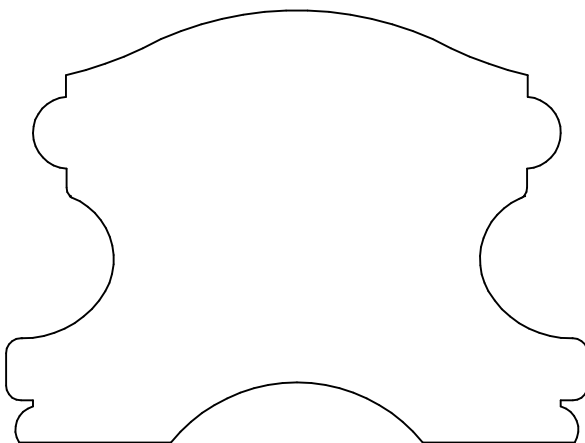

**KL 1917**  
2.250 x 3.030



**KL 1923B**  
1.213 x 2.500



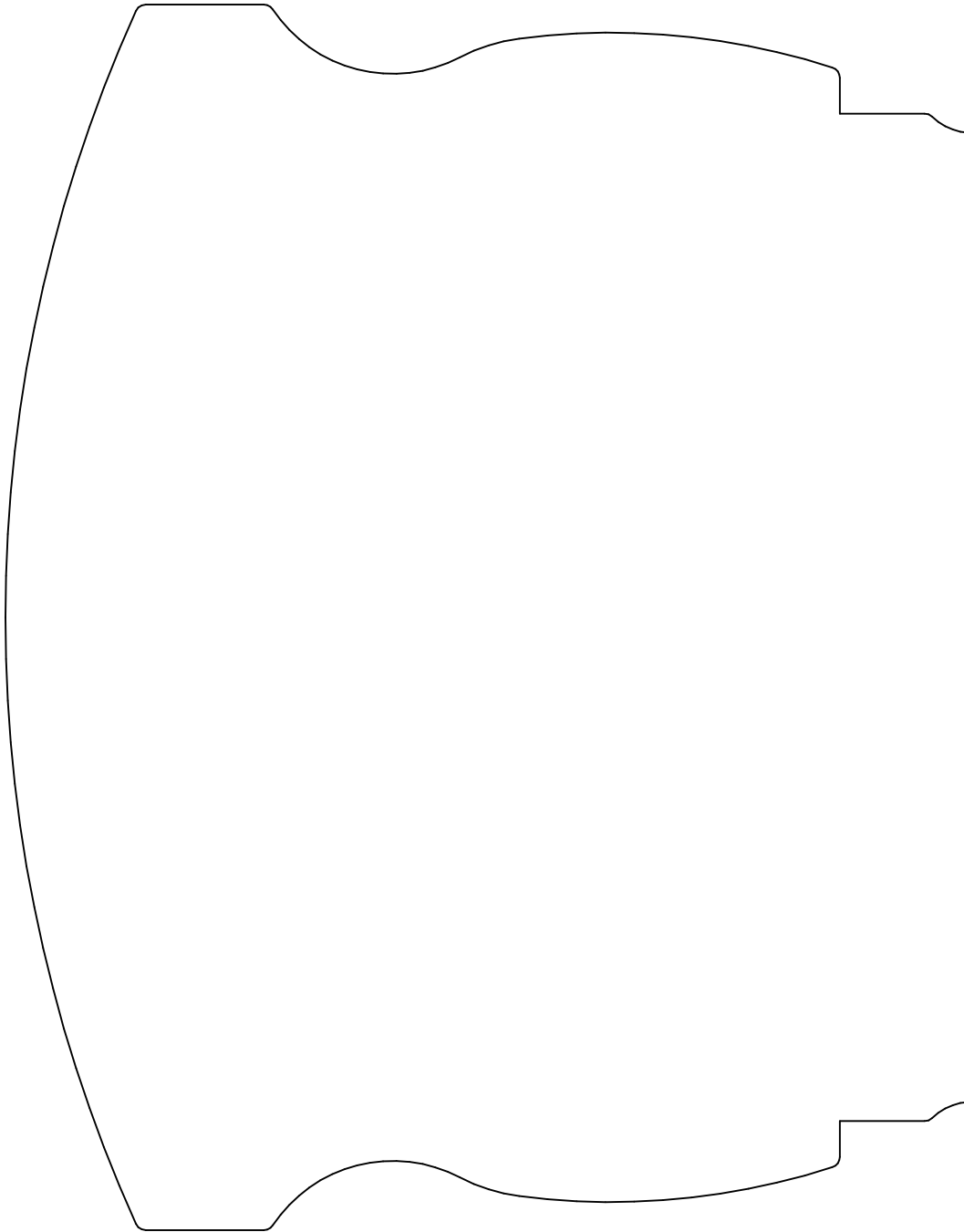

**KL 1914**  
5.500 x 7.000

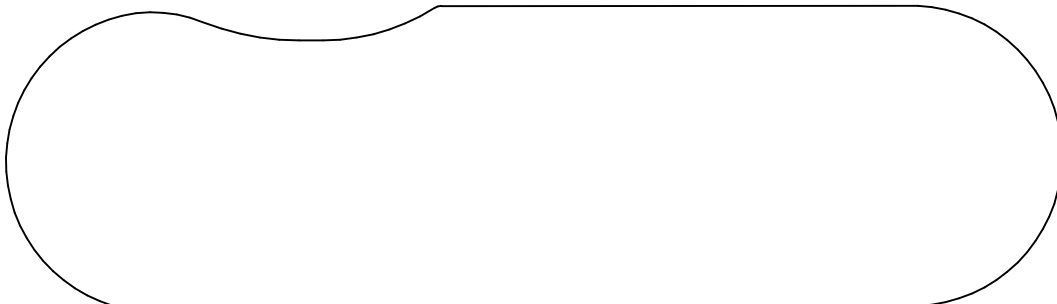

**KL 1919**  
1.562 x 5.500

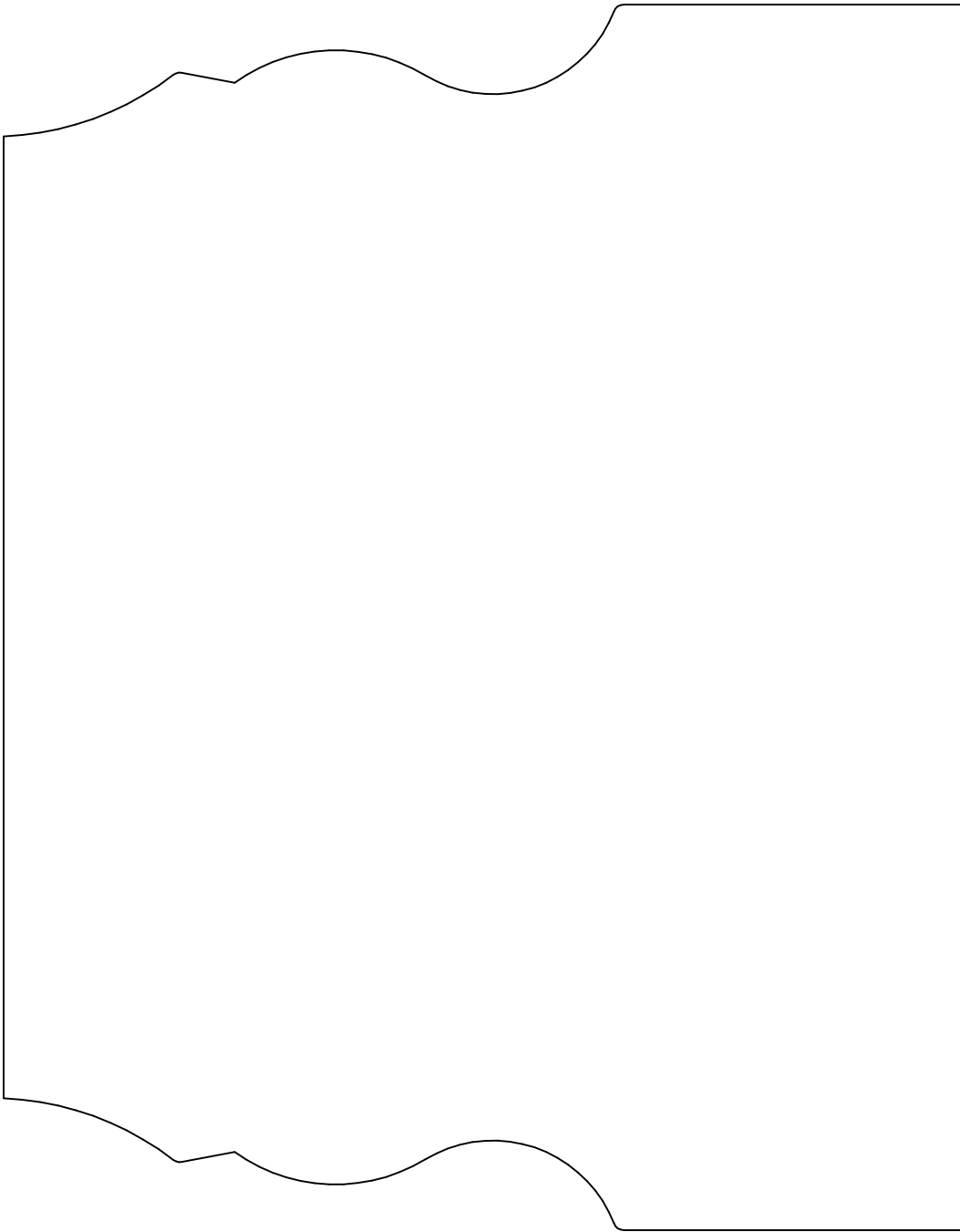

**KL 1915**  
5.500 x 7.000

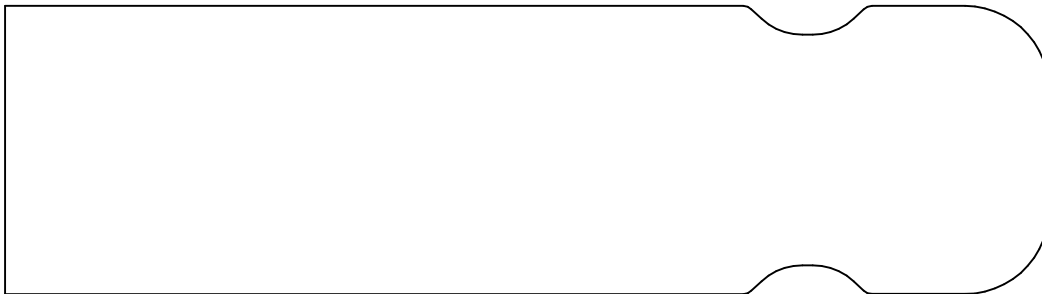

**KL 1922**  
1.500 x 5.437

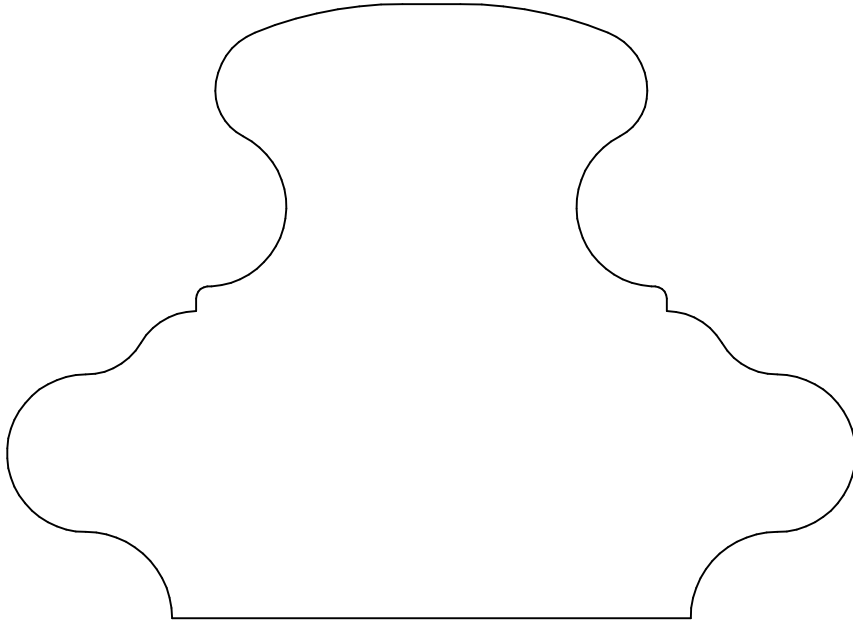

**KL 1920**  
3.200 x 4.421

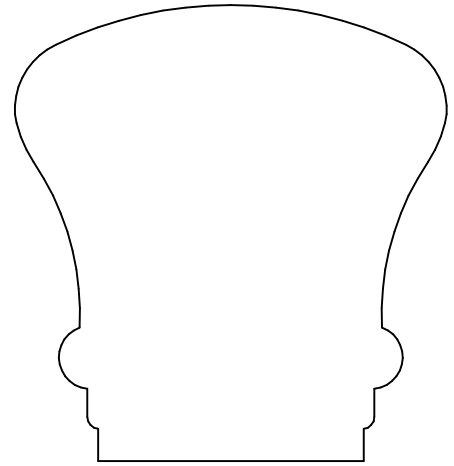

**KL 1925**  
2.375 x 2.250

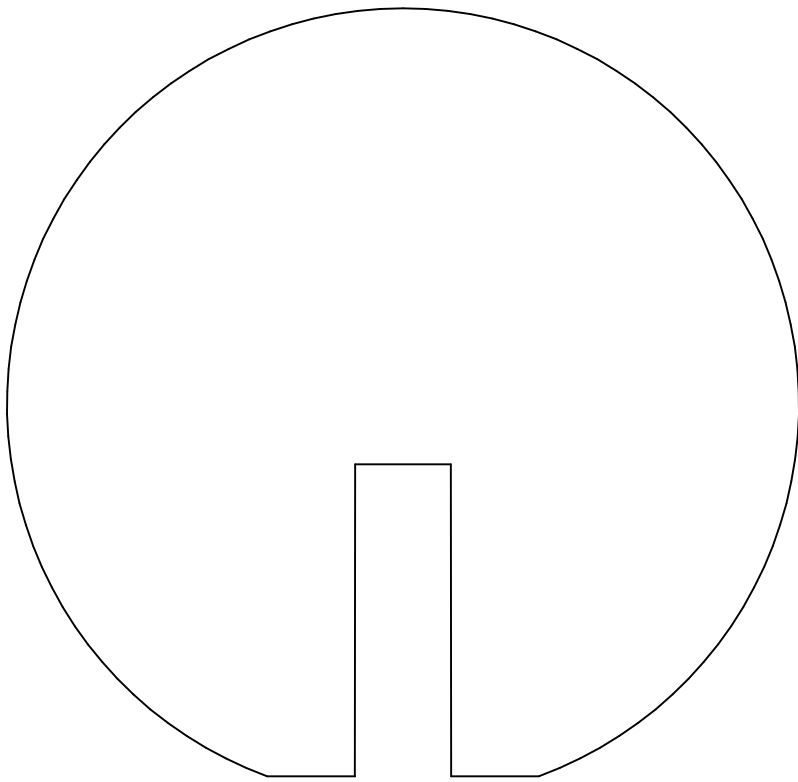

**KL 1921P**  
4.000 x 4.125

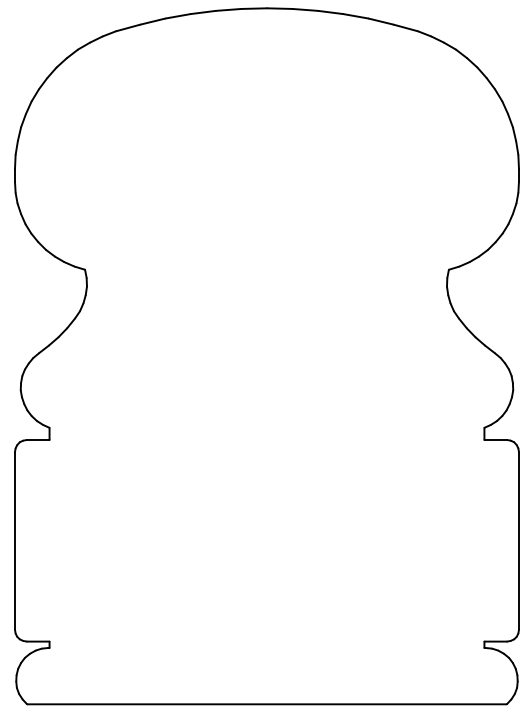

**KL 1926**  
3.625 x 2.625

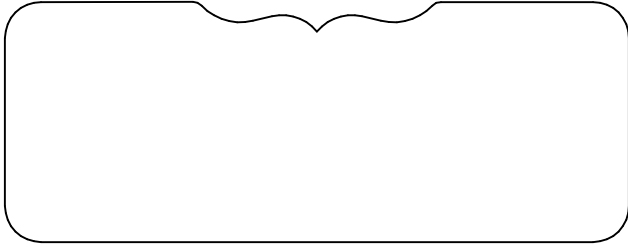

**KL 1924**  
1.250 x 3.250

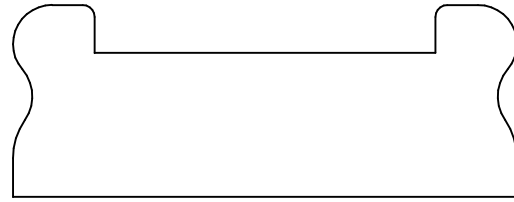

**KL 1927P**  
1.000 x 2.625

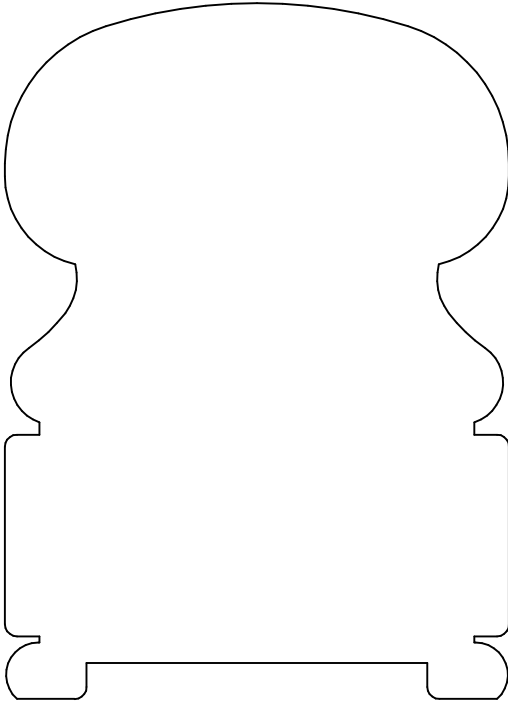

**KL 1926P**  
3.625 x 2.625

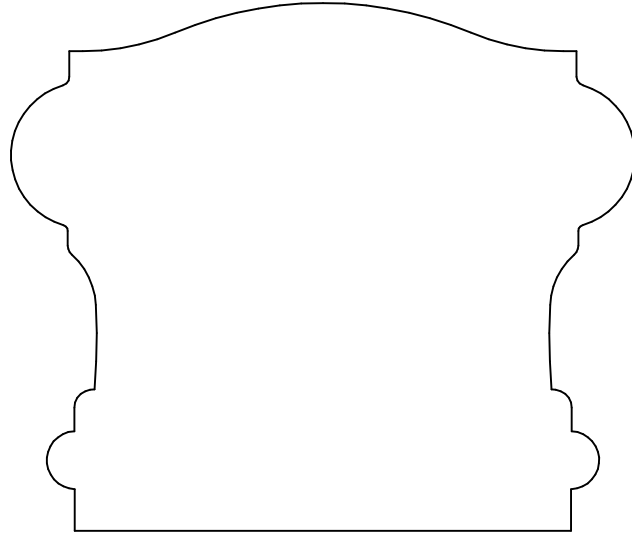

**KL 1928**  
2.750 x 3.250

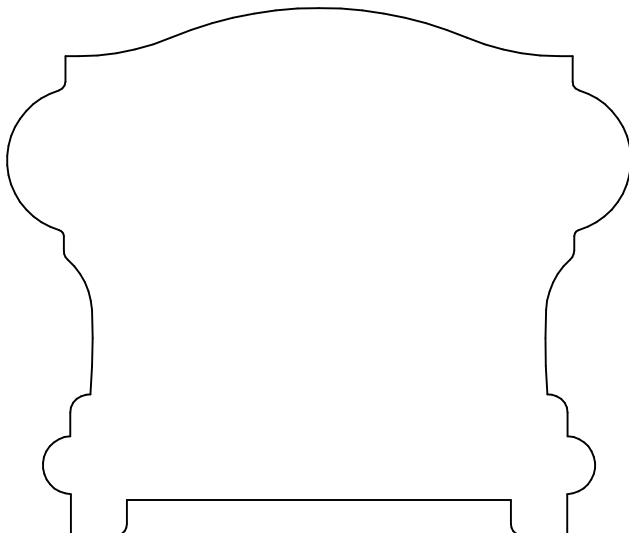

**KL 1928P**  
2.750 x 3.250

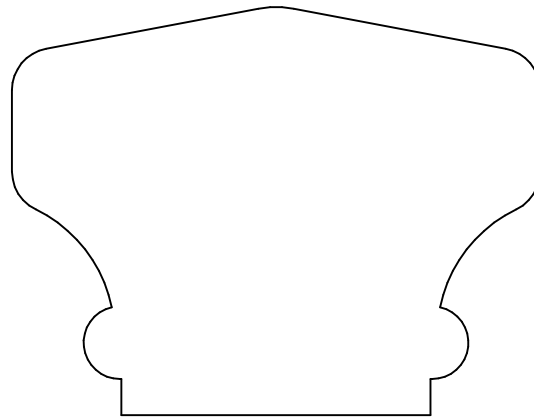

**KL 1929\_6701**  
2.125 x 2.750

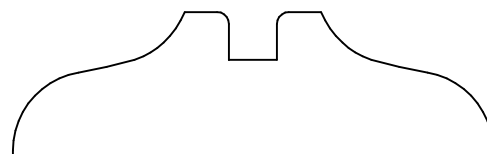

**KL 1936**  
.750 x 2.500

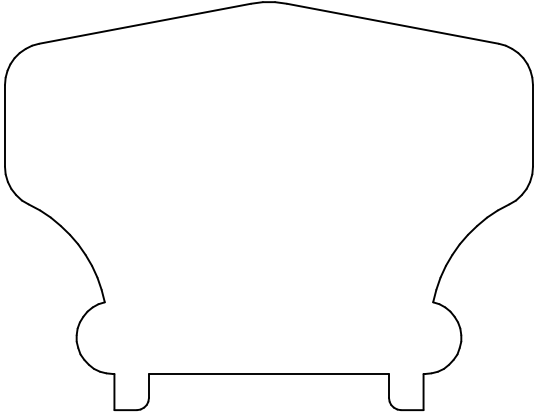

**KL 1929P\_6701P**  
2.125 x 2.750

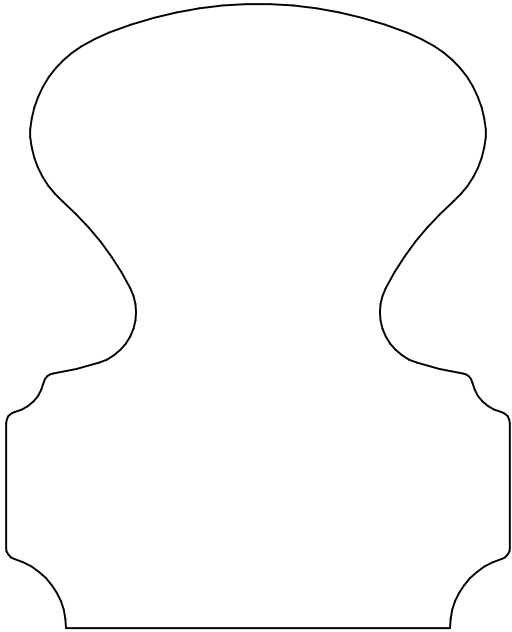

**KL 1932**  
3.250 x 2.625

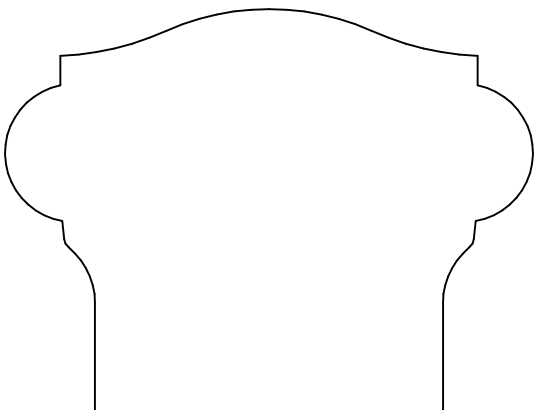

**KL 1933**  
2.094 x 2.750

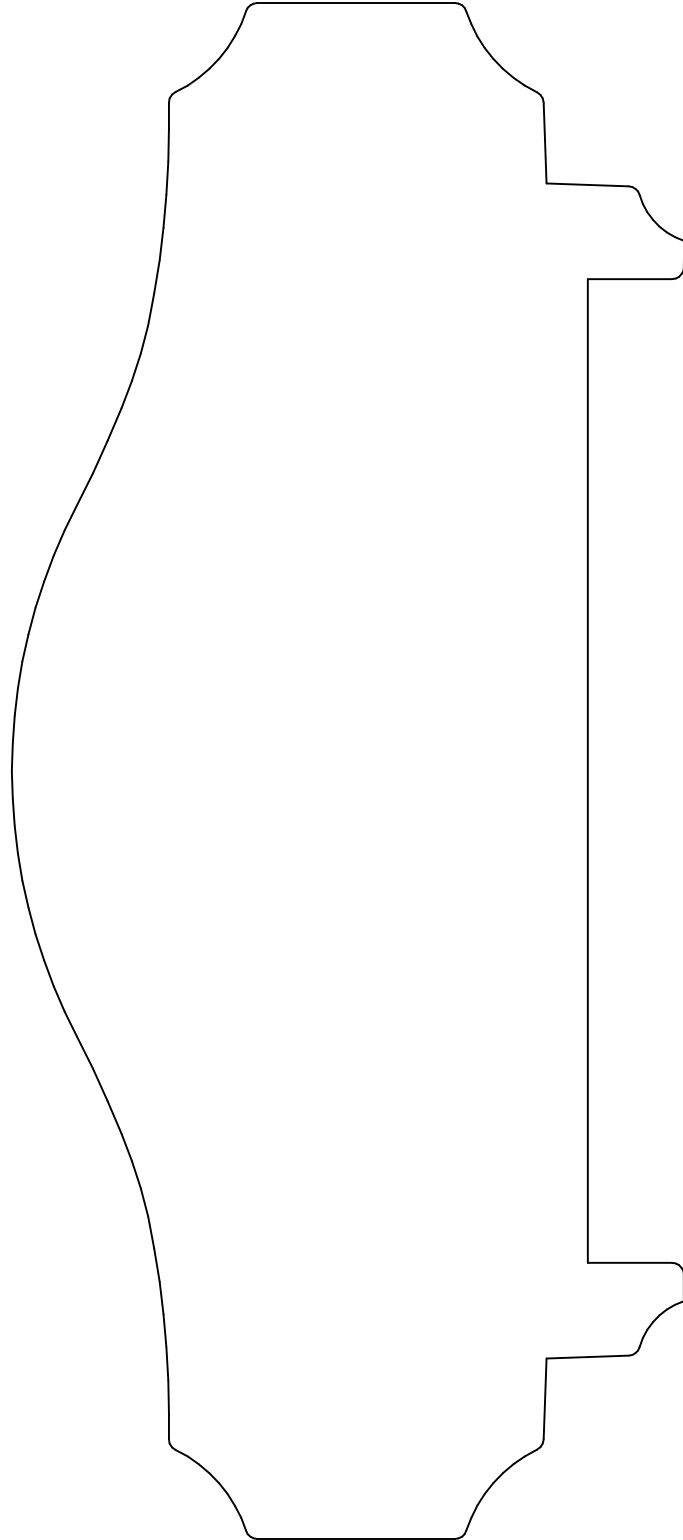

**KL 1930P**  
3.500 x 8.000

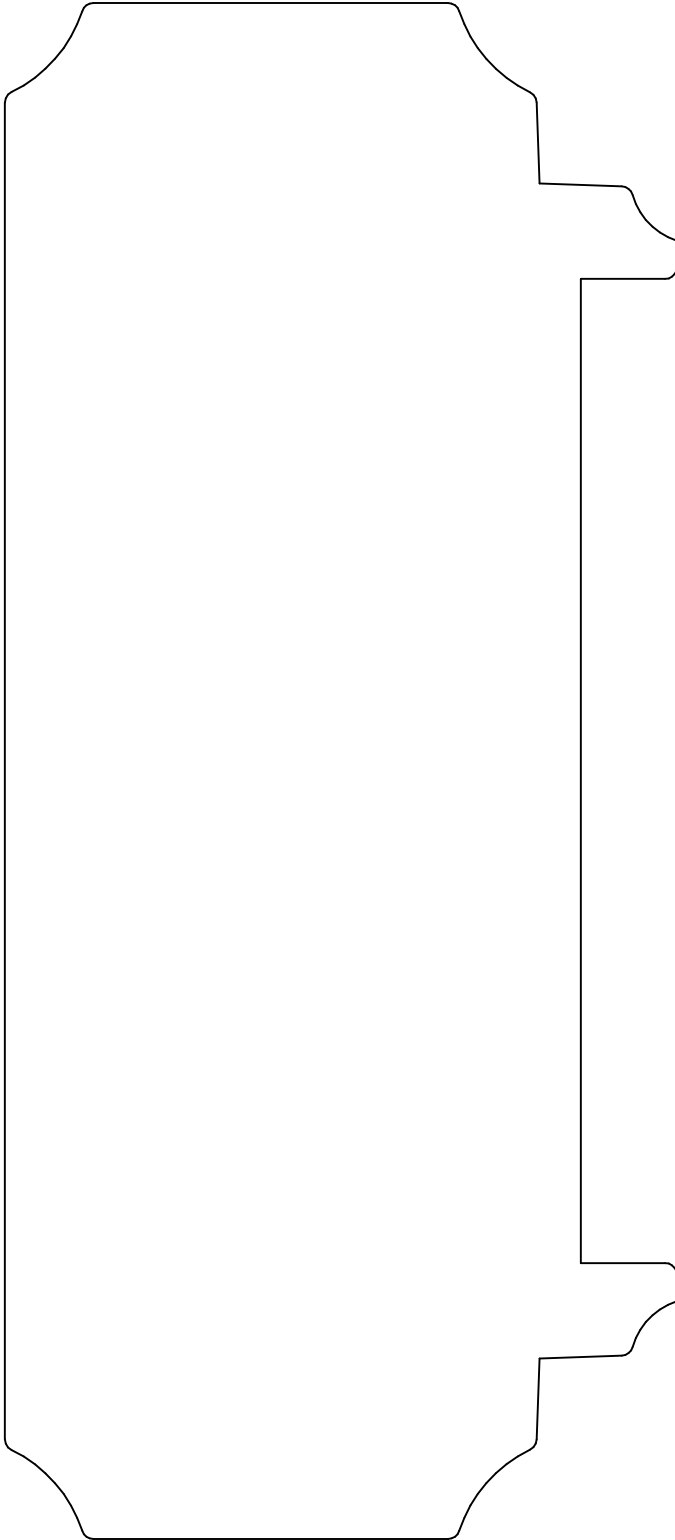

**KL 1931P**  
3.500 x 8.000

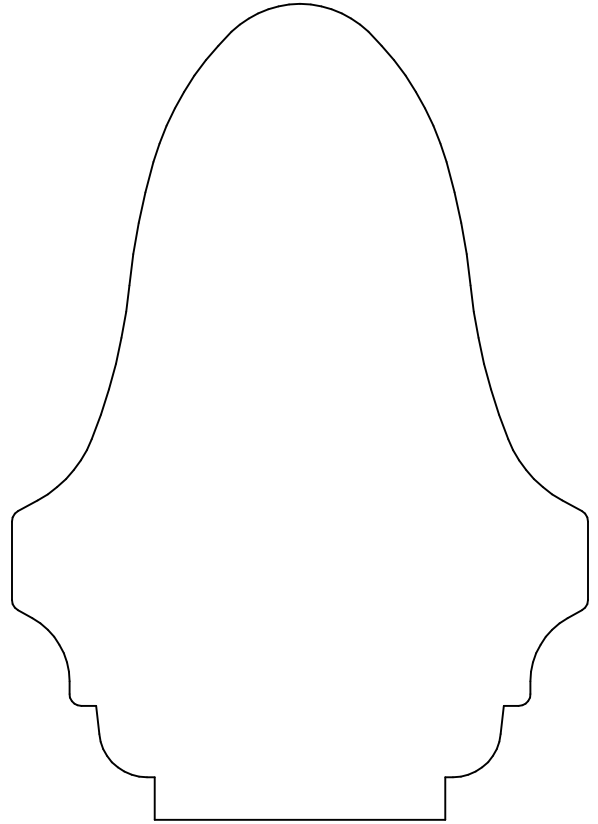

**KL 1935**  
4.250 x 3.000

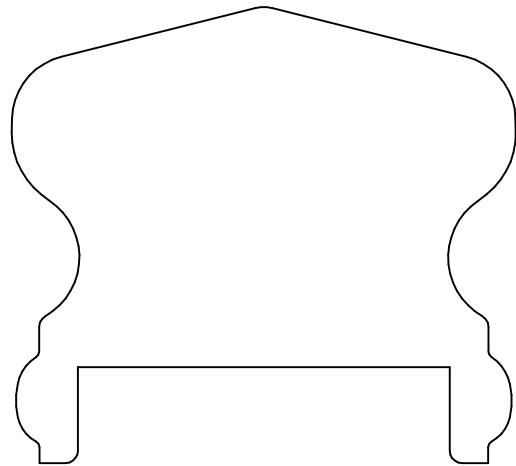

**KL 1937P**  
2.375 x 2.623



**KL 1950P**  
.687 x 2.000

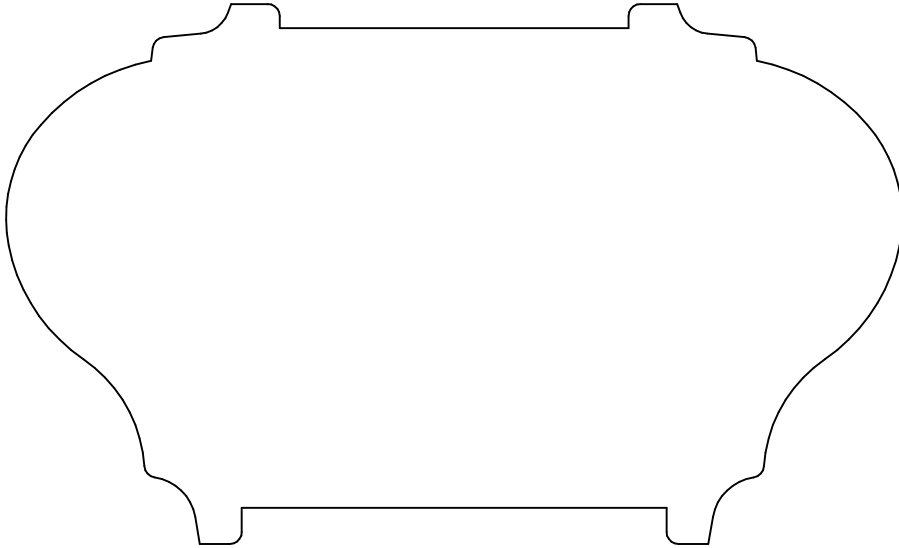

**KL 1934P**  
2.812 x 4.668

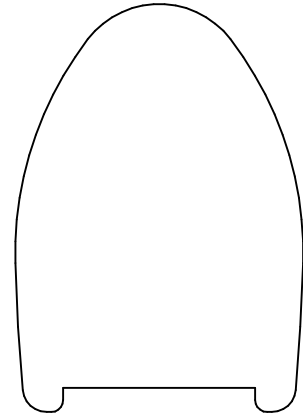

**KL 1941P**  
2.125 x 1.500

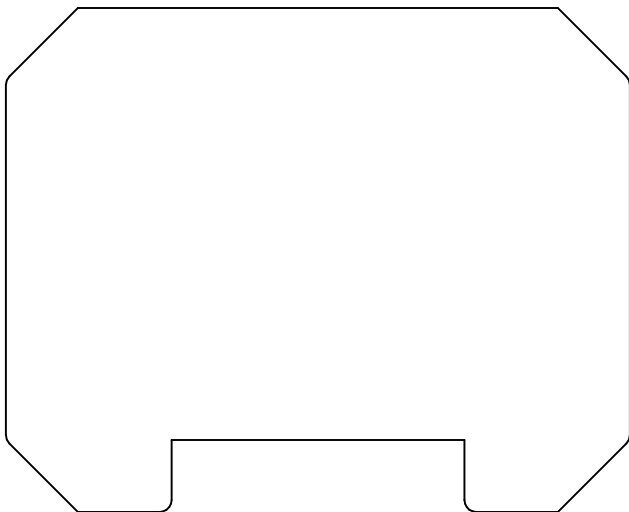

**KL 1938P**  
2.625 x 3.250

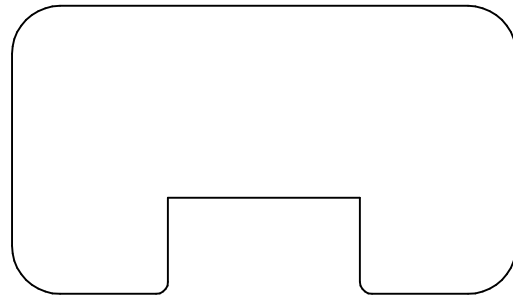

**KL 1939P**  
1.500 x 2.625

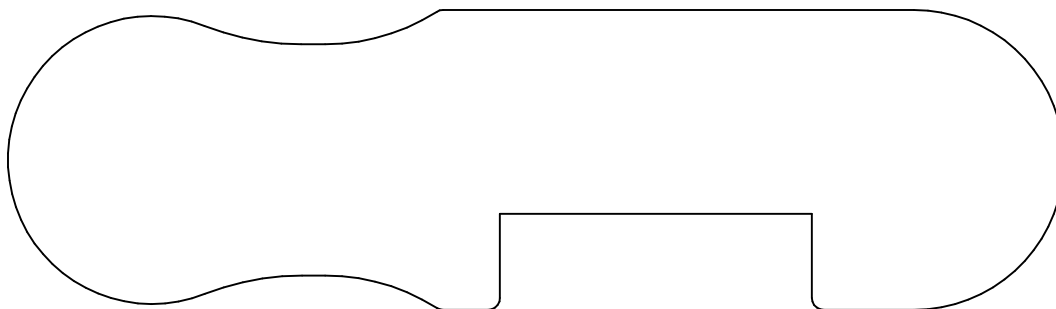

**KL 1943**  
1.562 x 5.500

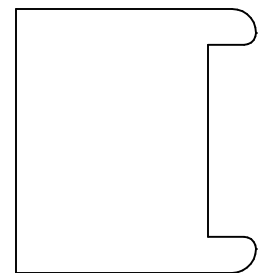

**KL 1954P**  
1.375 x 1.250

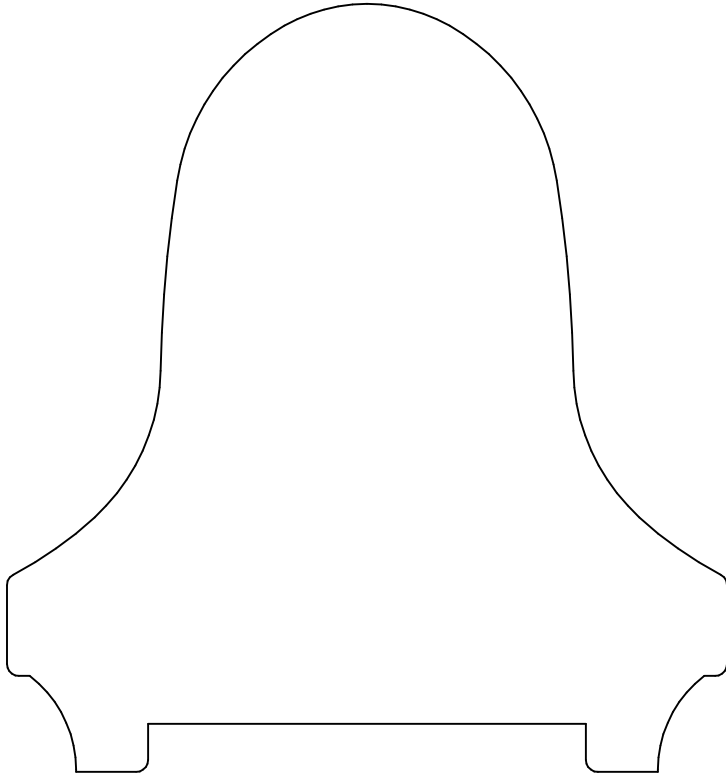

**KL 1940P**  
4.000 x 3.750

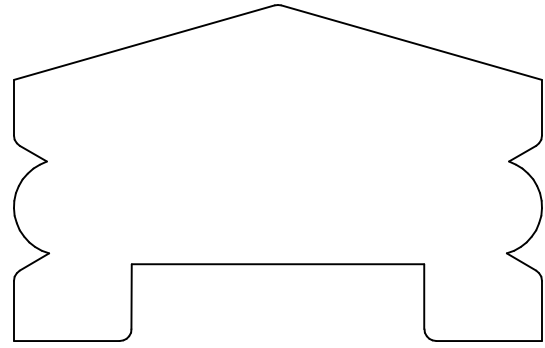

**KL 1946P**  
1.750 x 2.750

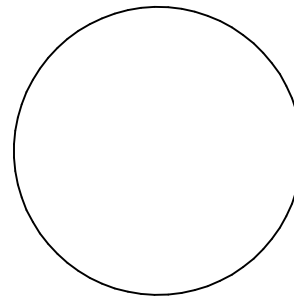

**KL 1956**  
1.500 x 1.500

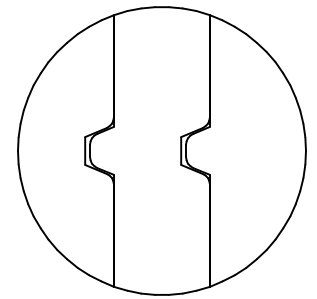

**KL 1956B**  
1.500 x 1.500

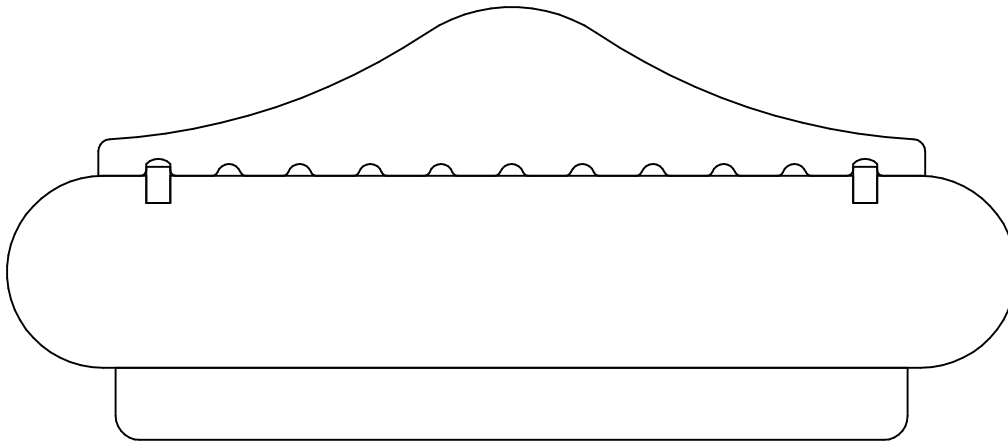

**KL 1944**  
4.509 x 10.513



**KL 1945**  
1.000 x 5.500



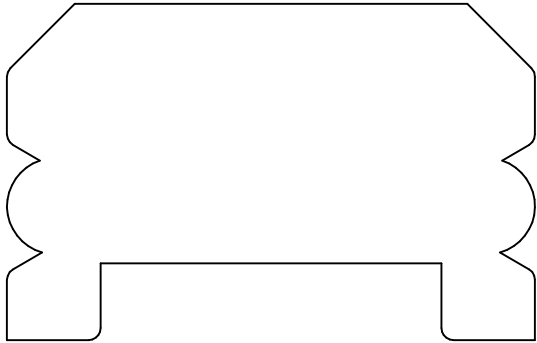

**KL 1947P**  
1.750 x 2.750

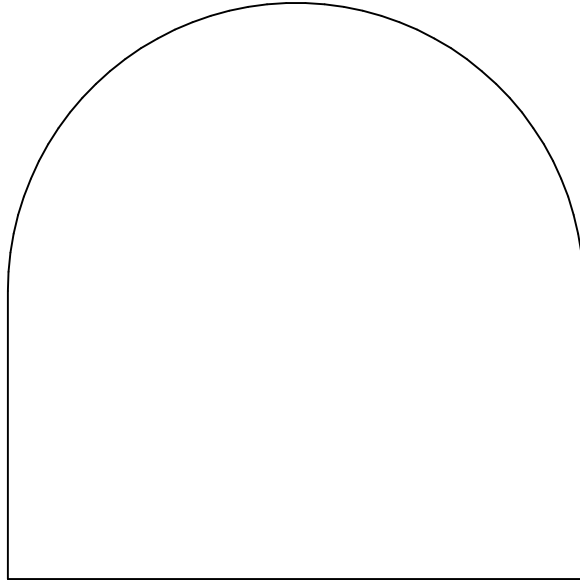

**KL 1948**  
3.000 x 3.000

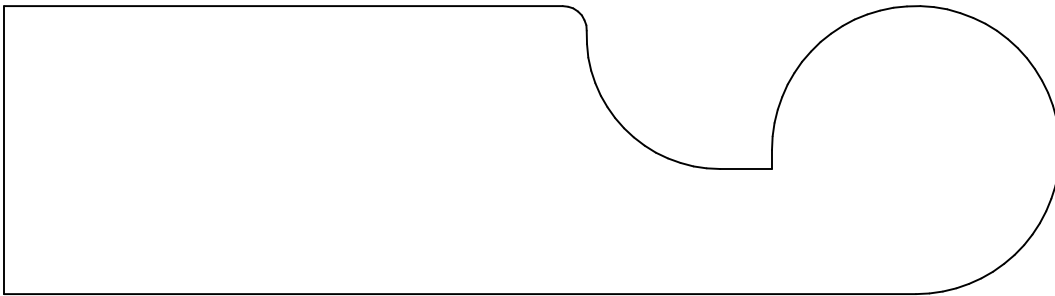

**KL 1949**  
1.500 x 5.500

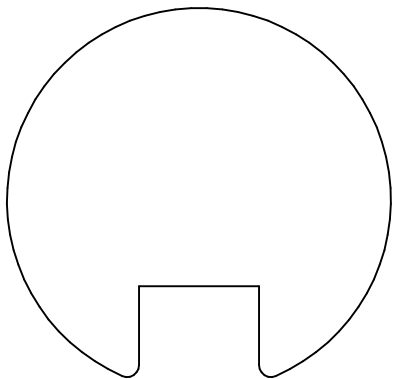

**KL 1952P**  
1.922 x 2.000

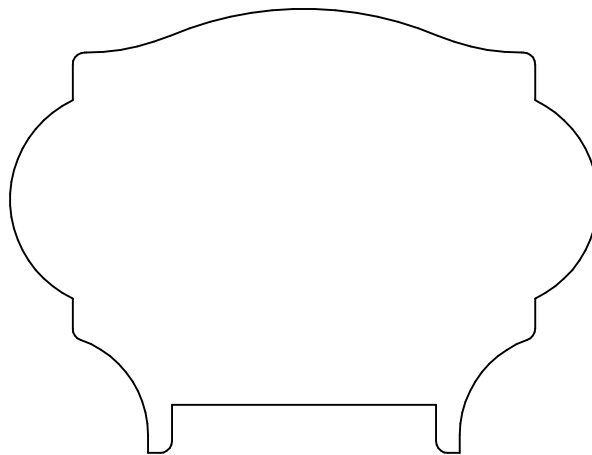

**KL 1953P**  
2.312 x 3.062

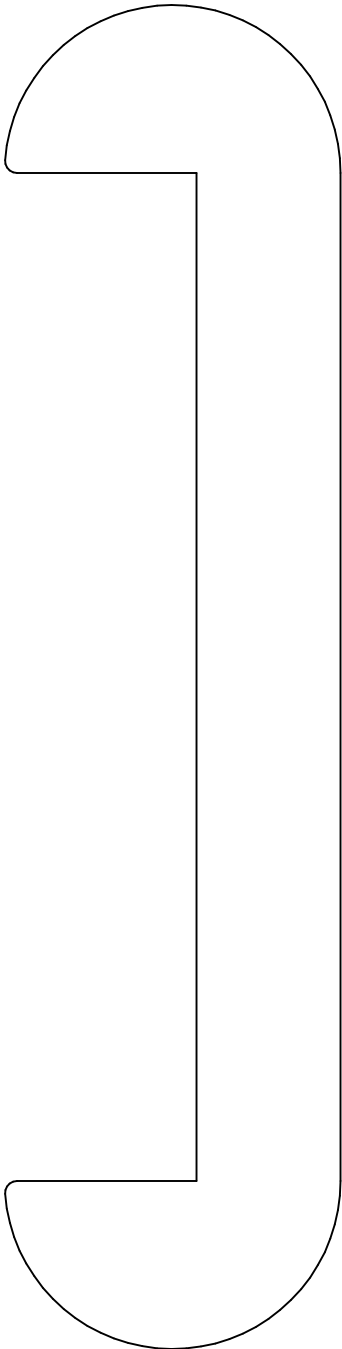

**KL 1951**  
1.748 x 7.000

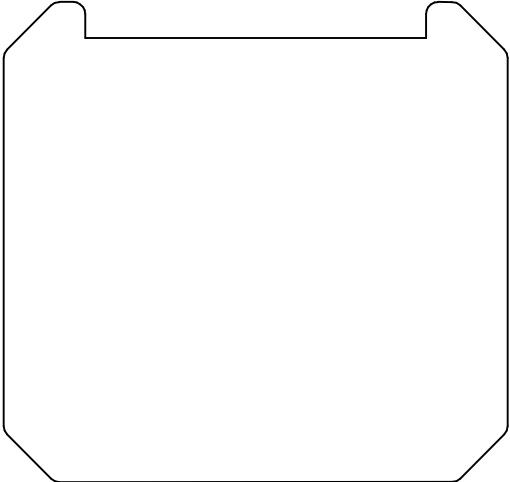

**KL 1957P**  
2.500 x 2.625

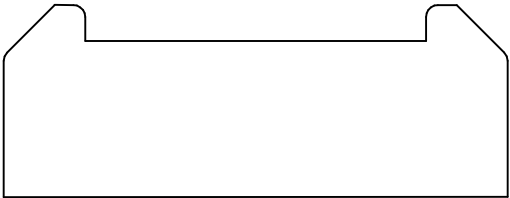

**KL 1958P**  
1.000 x 2.625

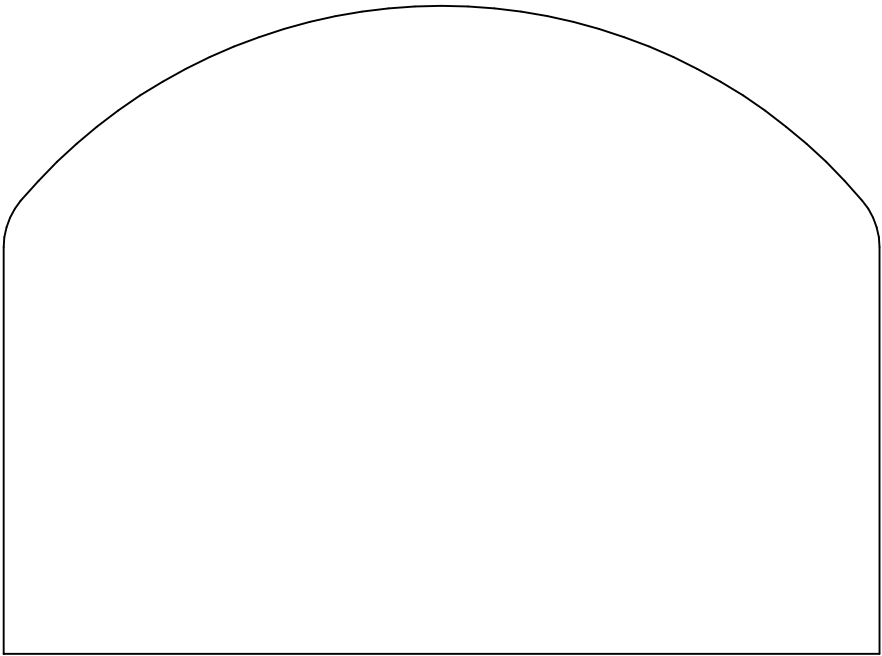

**KL 1959**  
3.375 x 4.562

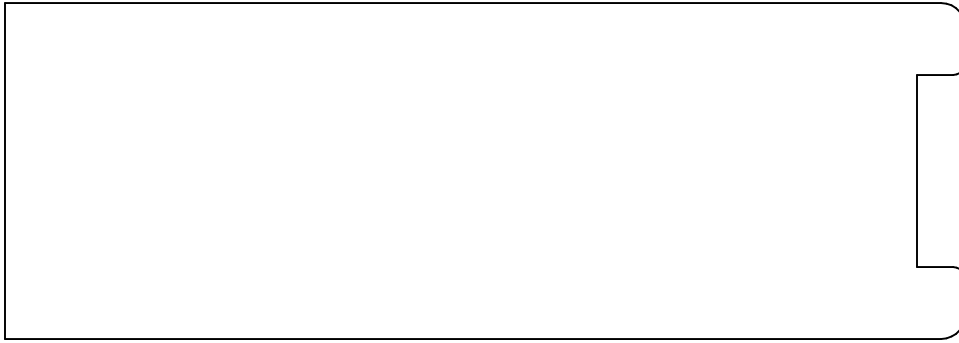

**KL 1955P**  
1.750 x 5.000

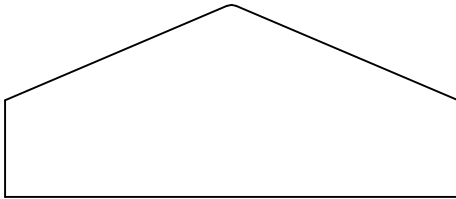

**KL 1960**  
1.000 x 2.360

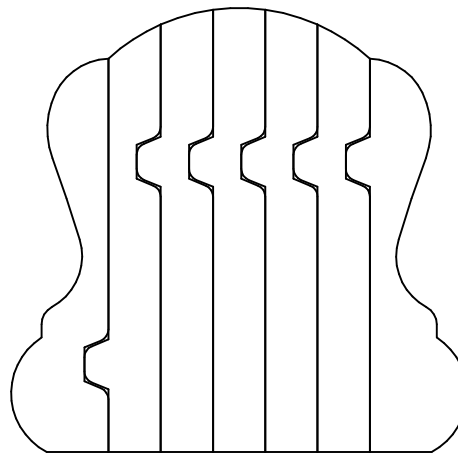

**KL 1961B**  
2.312 x 2.375

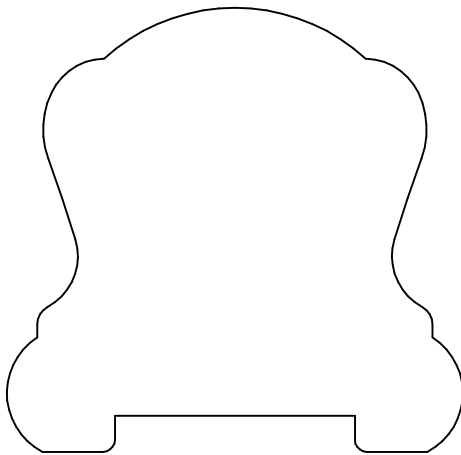

**KL 1961P\_6B10P**  
2.312 x 2.374

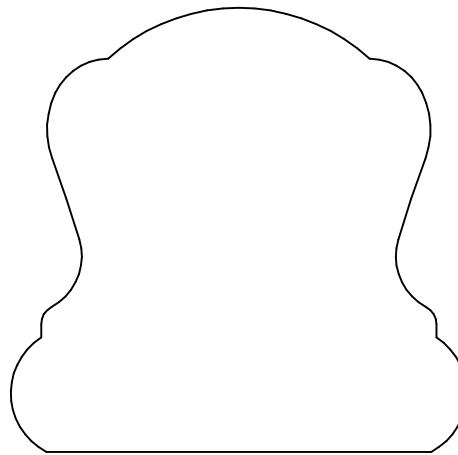

**KL 1961\_6B10**  
2.312 x 2.375

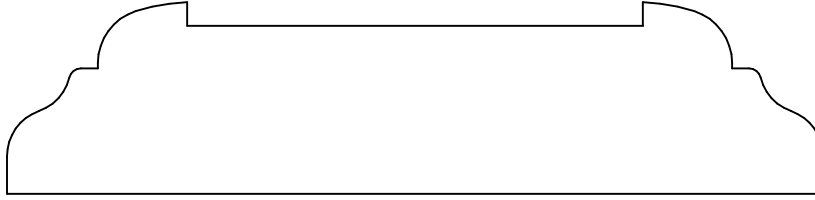

**KL 1962P**  
1.000 x 4.250

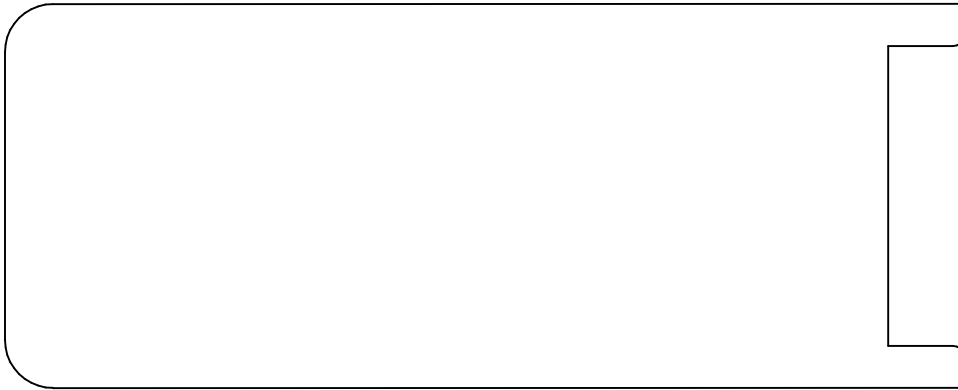

**KL 1963P**  
2.000 x 5.000

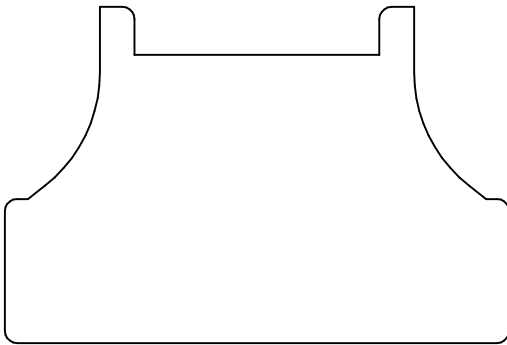

**KL 1964P**  
1.750 x 2.625

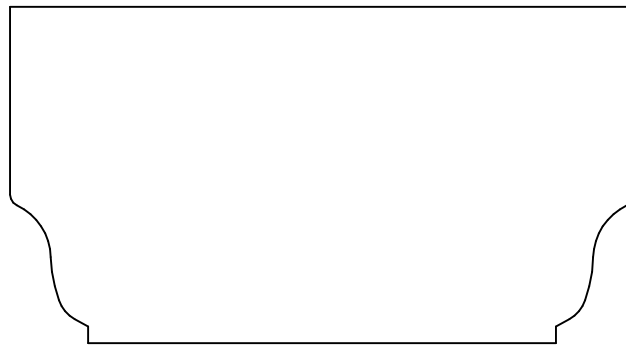

**KL 1969**  
1.750 x 3.250

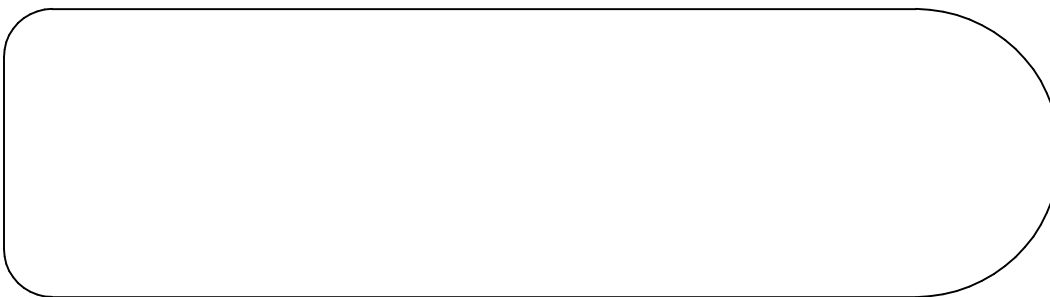

**KL 1965**  
1.500 x 5.500

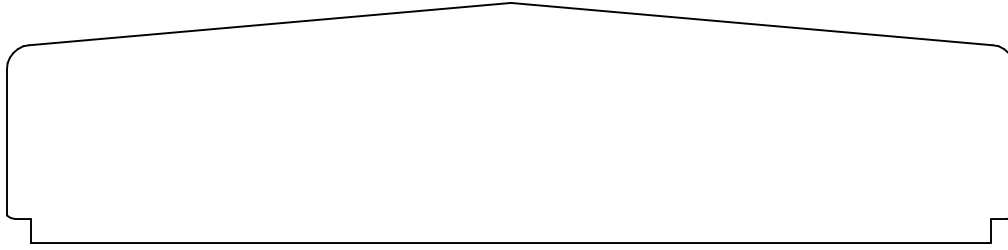

**KL 1966**  
1.250 x 5.250

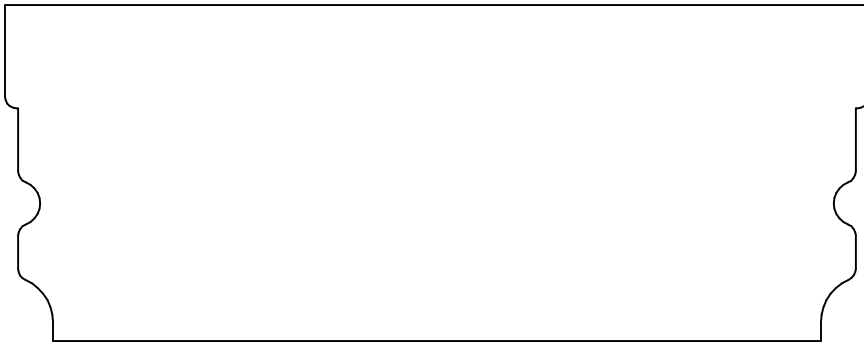

**KL 1967**  
1.750 x 4.500

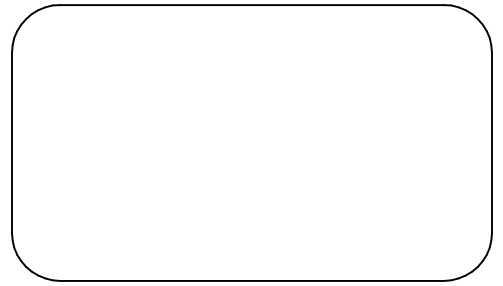

**KL 1974**  
1.437 x 2.500

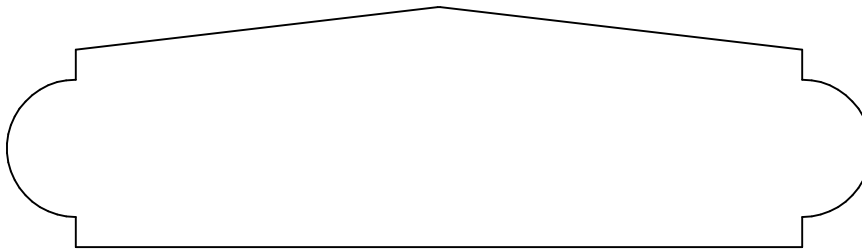

**KL 1968**  
1.250 x 4.500

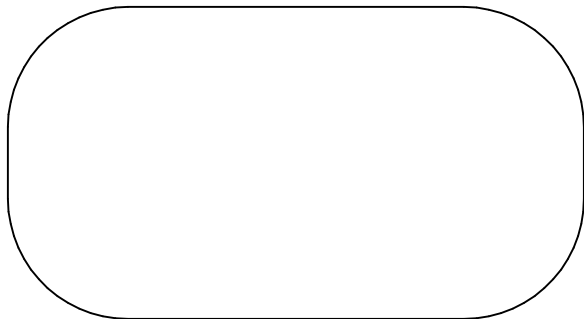

**KL 1970**  
1.625 x 3.000

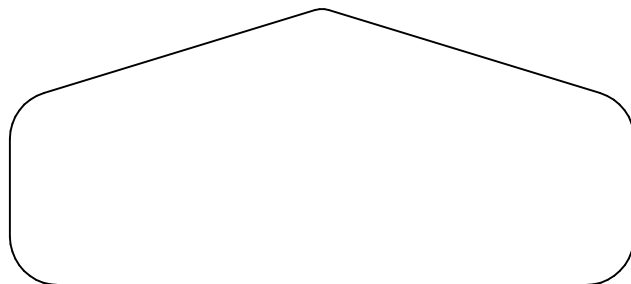

**KL 1973**  
1.437 x 3.250

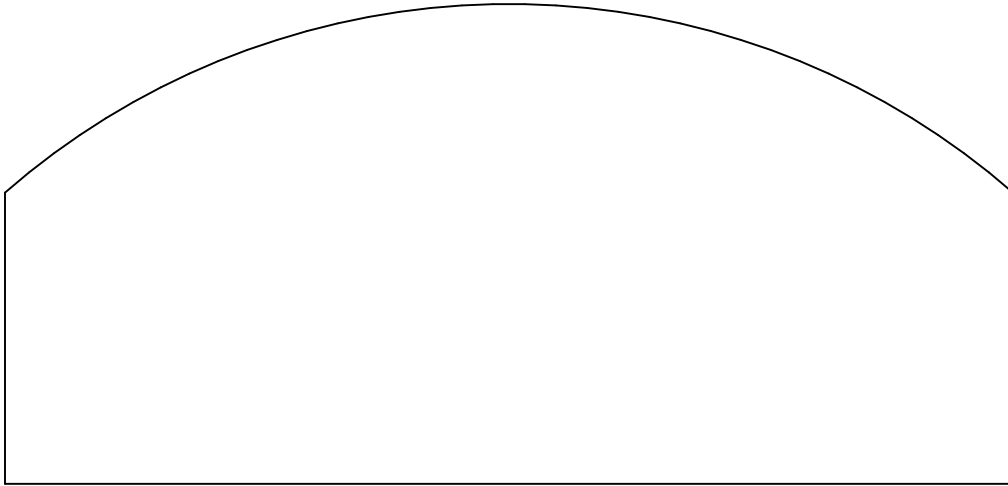

**KL 1971**  
2.500 x 5.250

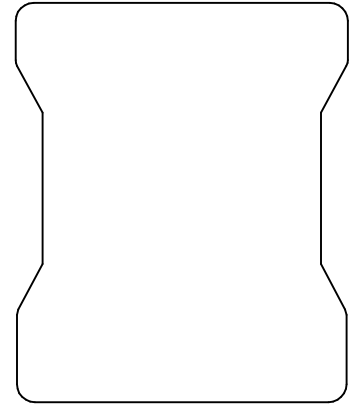

**KL 1985**  
2.079 x 1.716

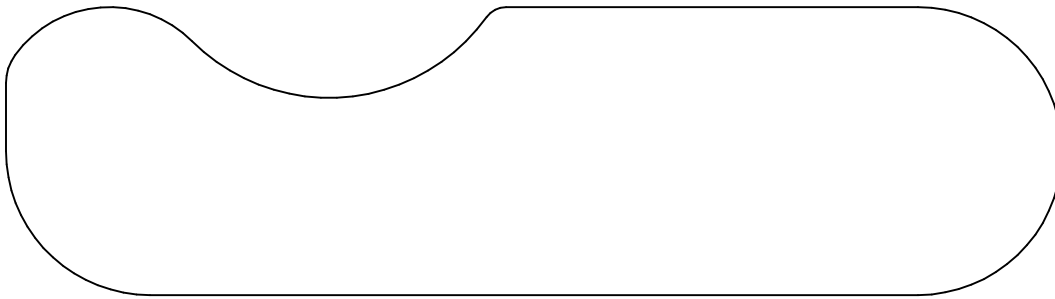

**KL 1972**  
1.500 x 5.500

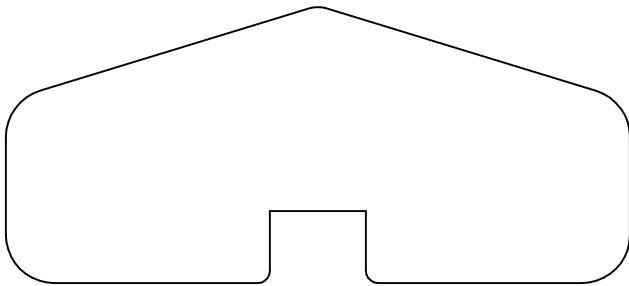

**KL 1973P**  
1.437 x 3.250

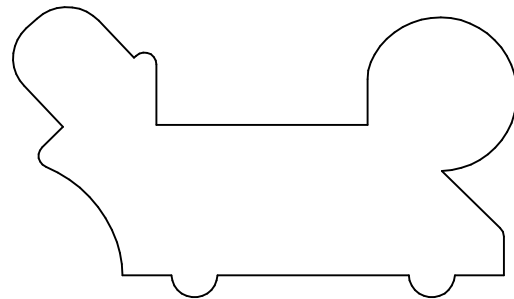

**KL 1976**  
1.512 x 2.625

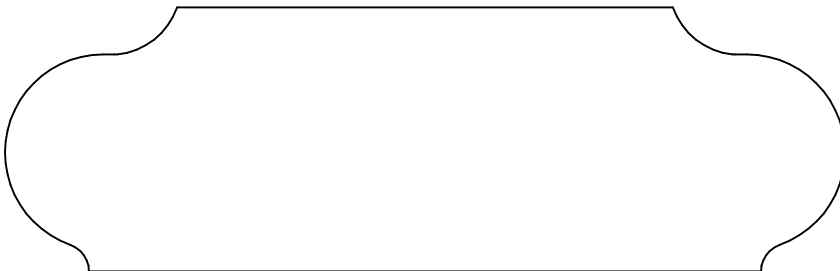

**KL 1981**  
1.375 x 4.375

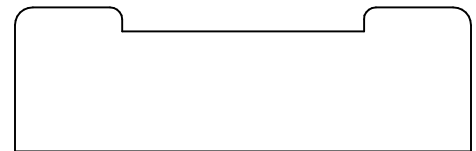

**KL 1986P**  
.750 x 2.375

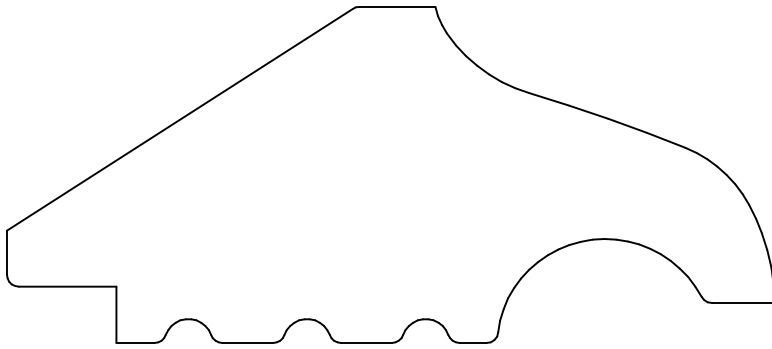

**KL 1975**  
1.750 x 4.000

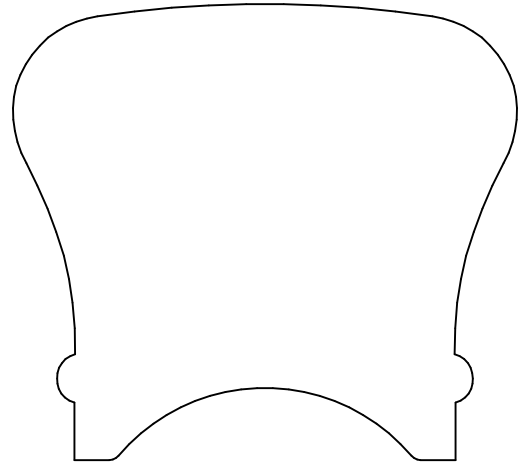

**KL 1977**  
2.375 x 2.625

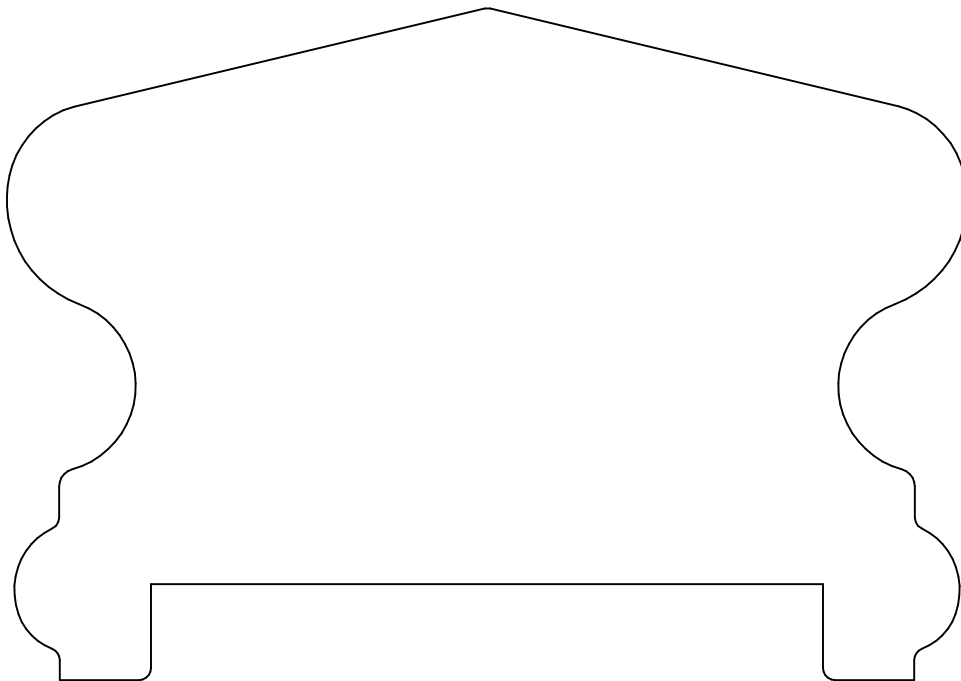

**KL 1978P**  
3.500 x 5.000

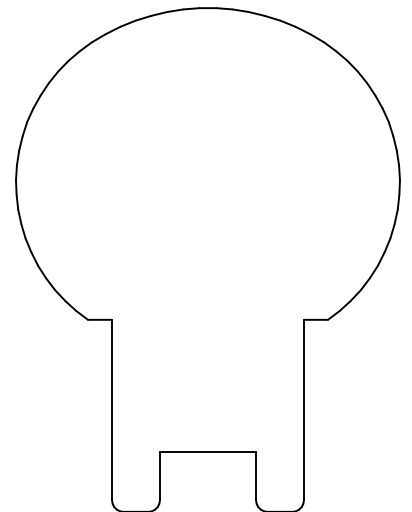

**KL 1983P**  
2.625 x 2.000

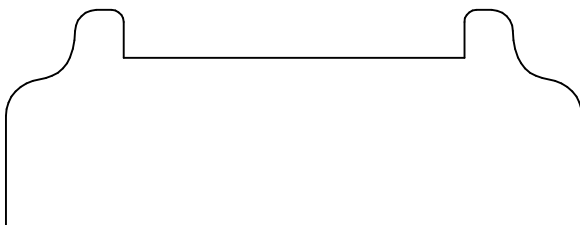

**KL 1988P**  
1.125 x 3.000

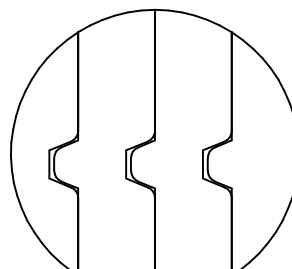

**KL 1997B**  
1.359 x 1.500

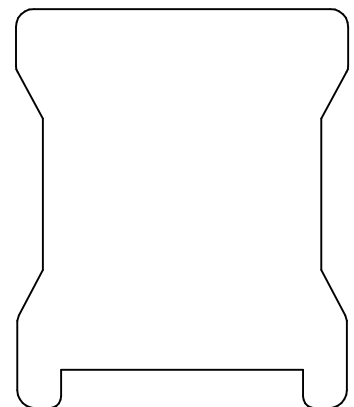

**KL 1985P**  
2.079 x 1.730

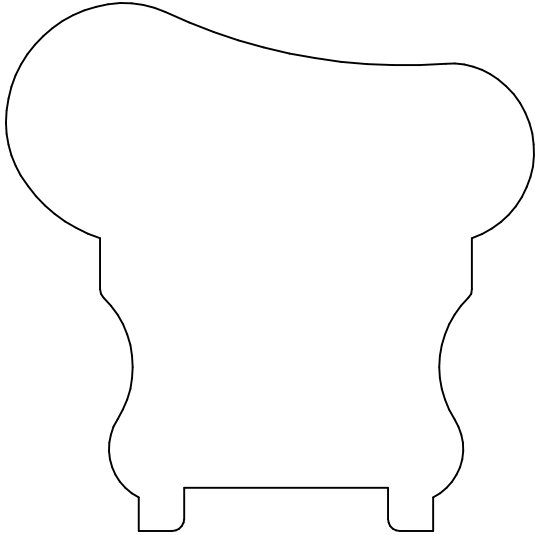

**KL 1979P**  
2.750 x 2.750

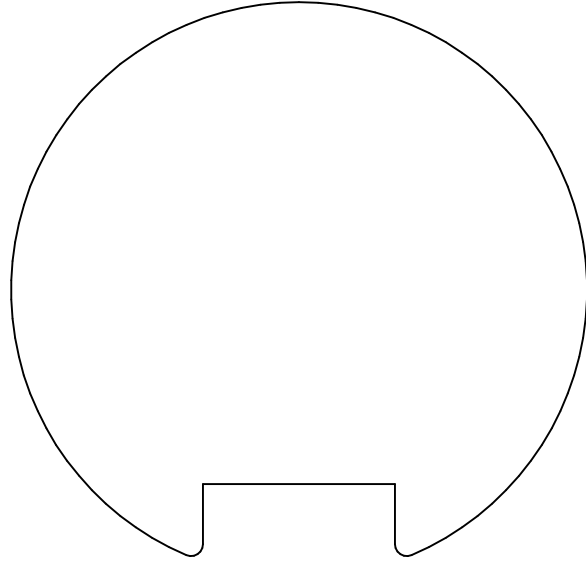

**KL 1980P**  
2.886 x 3.000

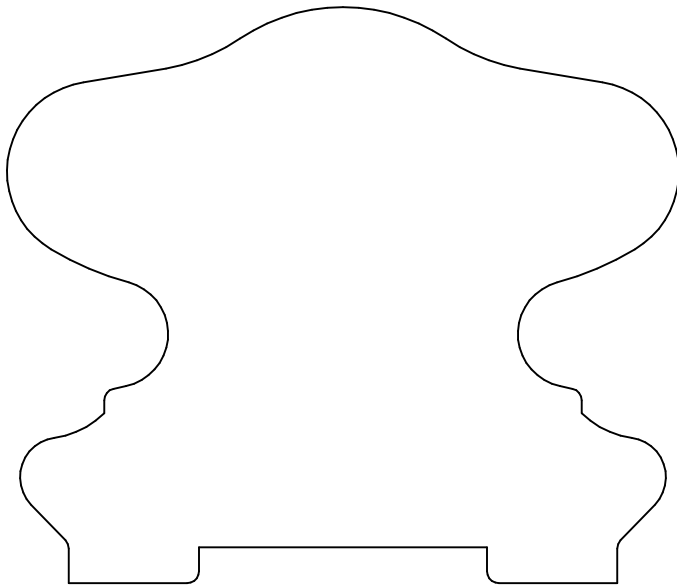

**KL 1984P**  
3.000 x 3.500

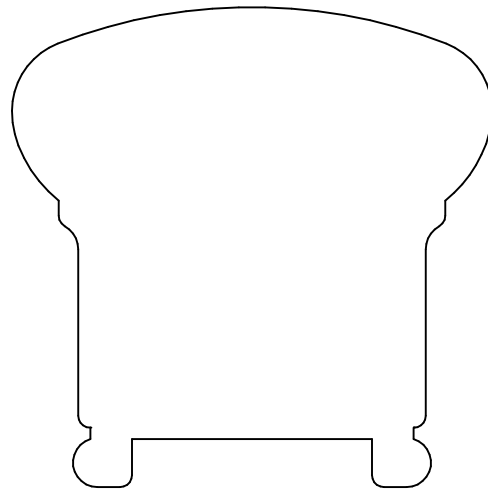

**KL 1987P**  
2.500 x 2.500

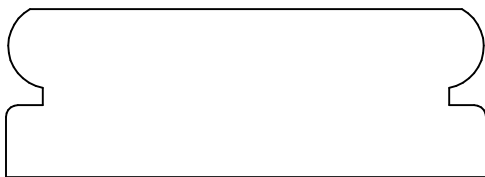

**KL 1990**  
.875 x 2.500

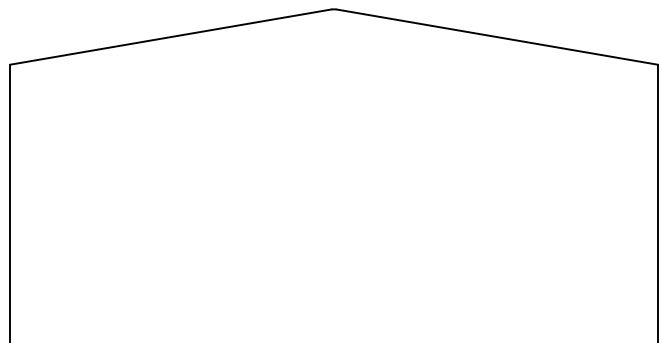

**KL 1989**  
1.750 x 3.375



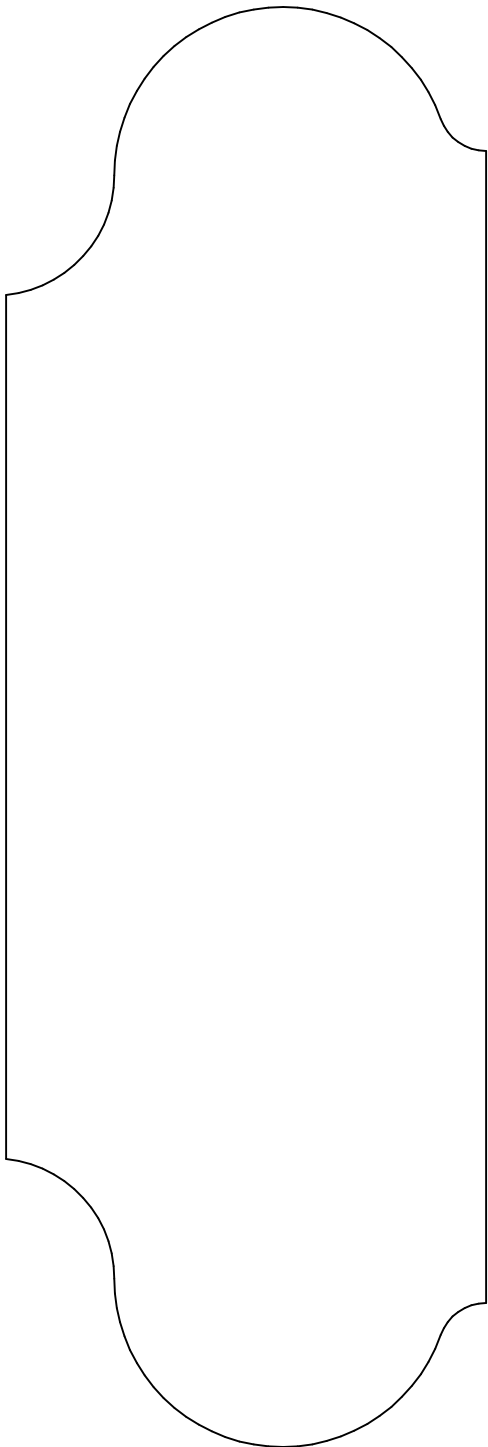

**KL 1982**  
2.500 x 7.500



**KL 1998**  
.312 x 1.750

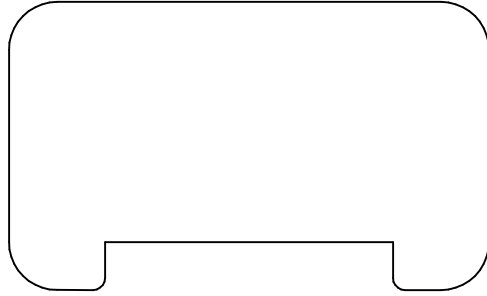

**KL 1991P**  
1.500 x 2.500

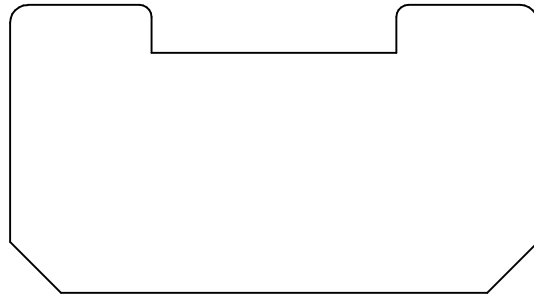

**KL 1992P**  
1.500 x 2.750

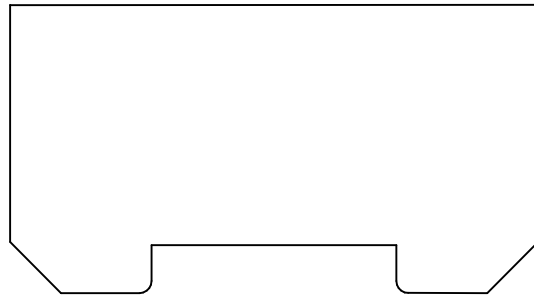

**KL 1993P**  
1.500 x 2.750

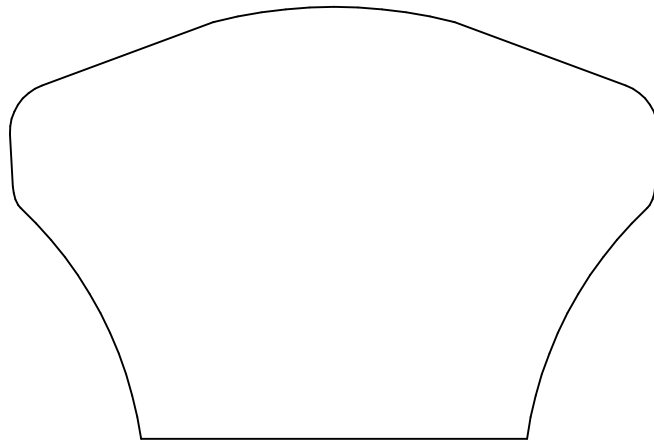

**KL 1995**  
2.250 x 3.375

# CUSTOM PROFILES

# Handrail

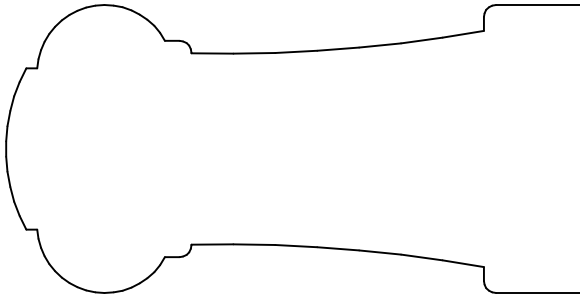

**KL 1994**  
1.500 x 3.000

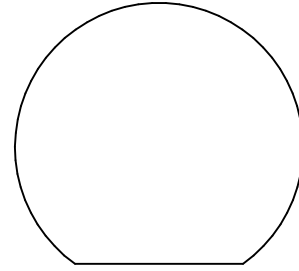

**KL 1997**  
1.359 x 1.500

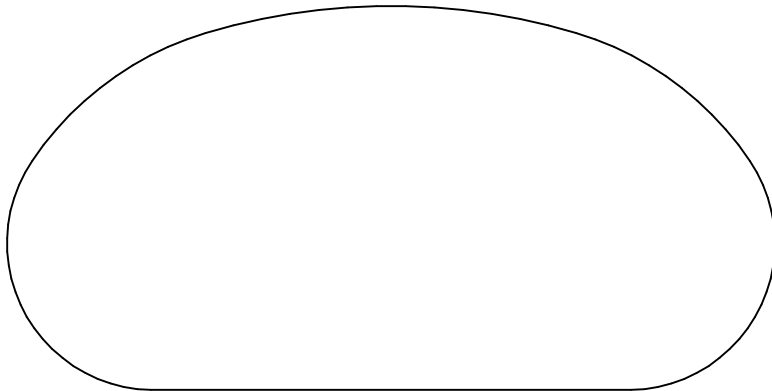

**KL 1996**  
2.000 x 4.000

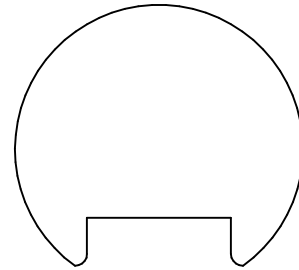

**KL 1997P**  
1.359 x 1.500

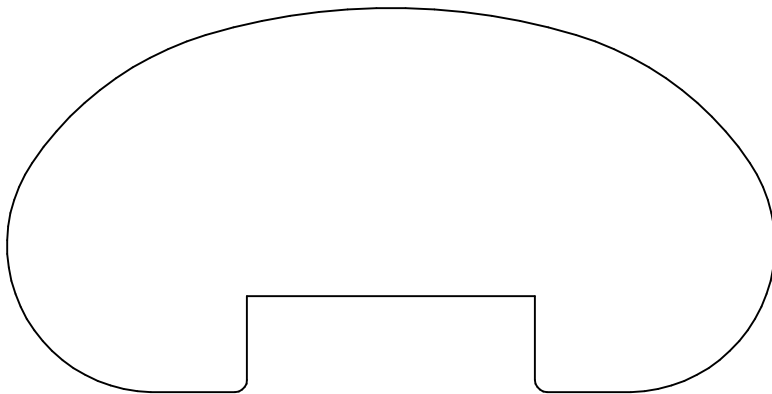

**KL 1996P**  
2.000 x 4.000

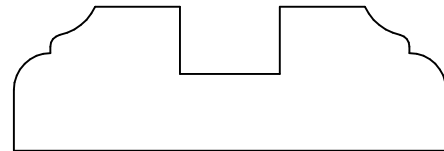

**KL 3901P**  
.750 x 2.250

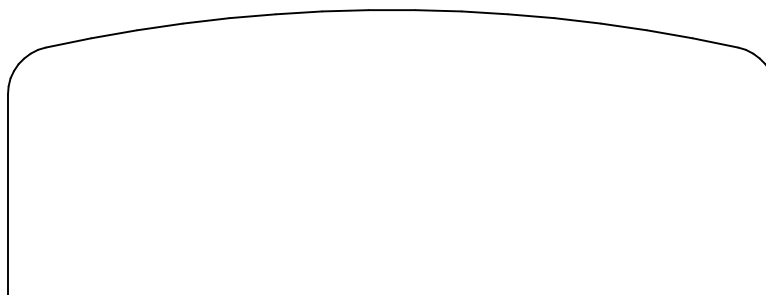

**KL 3900**  
1.500 x 4.000

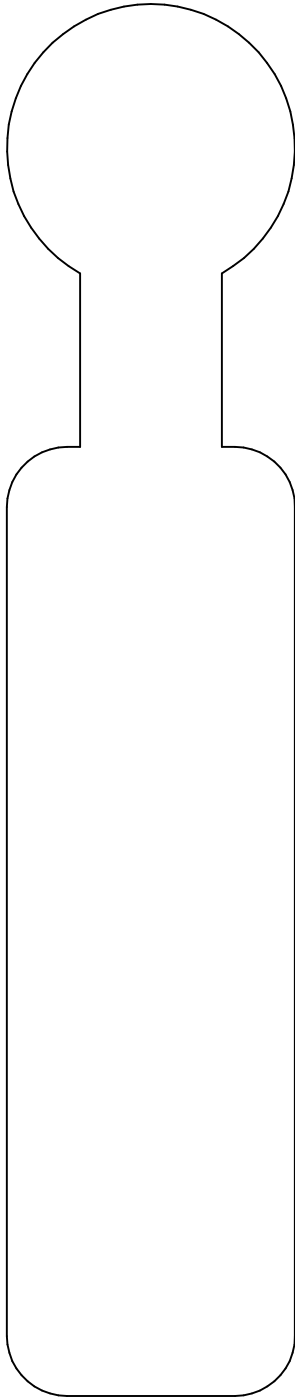

**KL 1999**  
1.500 x 7.250

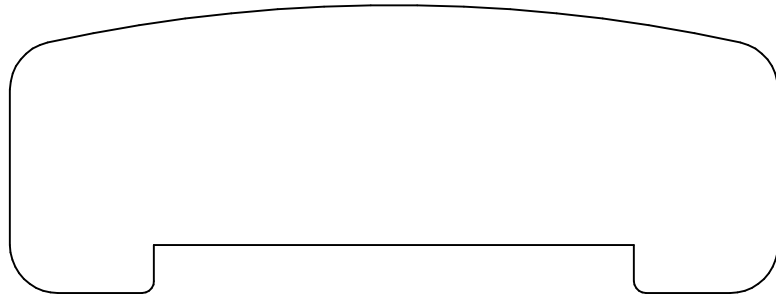

**KL 3900P**  
1.500 x 4.000

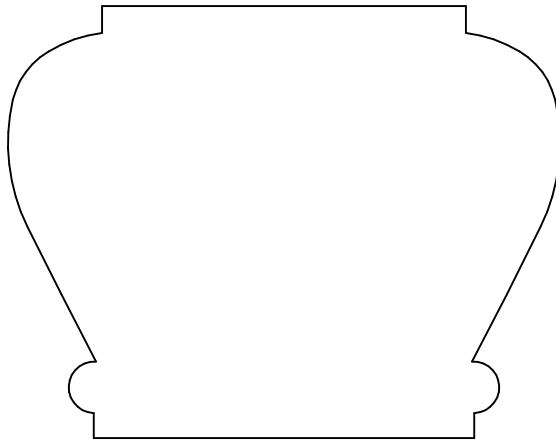

**KL 3902**  
2.250 x 2.875

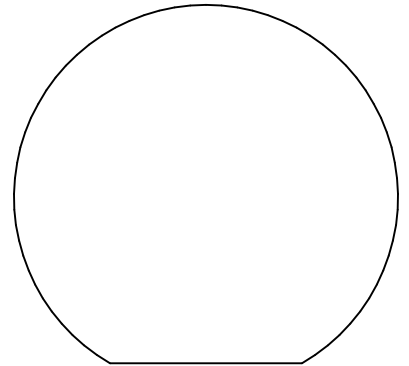

**KL 3907**  
1.866 x 2.000

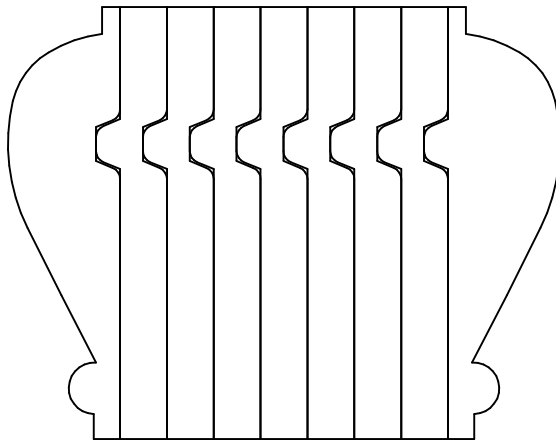

**KL 3902B**  
2.250 x 2.875

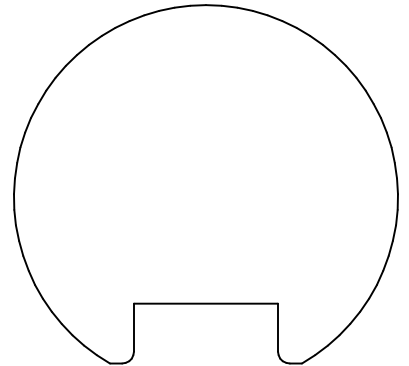

**KL 3907P**  
1.866 x 2.000



**KL 3903P**  
1.500 x 5.125

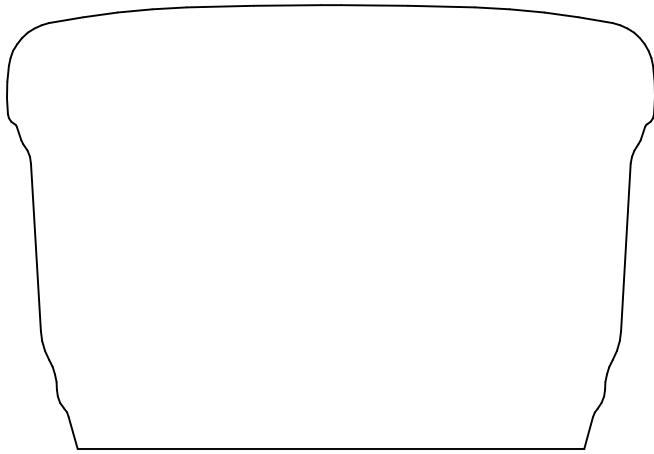

**KL 3904**  
2.312 x 3.375

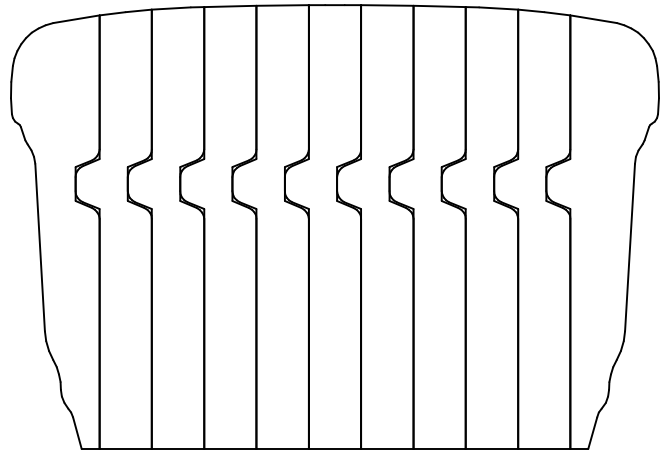

**KL 3904B**  
2.312 x 3.375

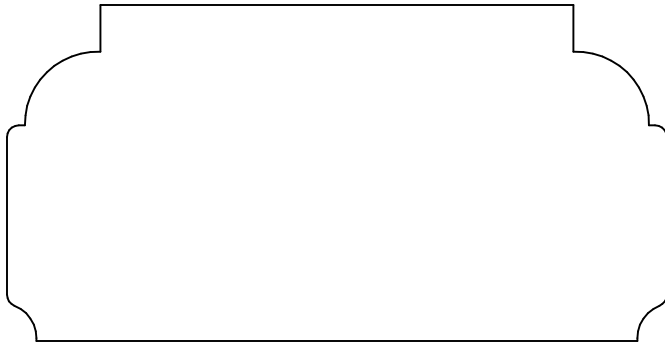

**KL 3905**  
1.750 x 3.437

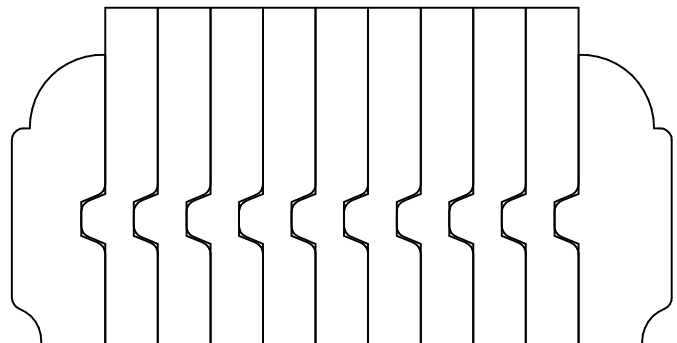

**KL 3905B**  
1.750 x 3.437

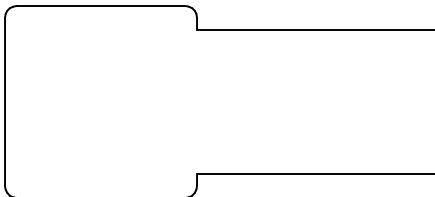

**KL 3910**  
1.000 x 2.250

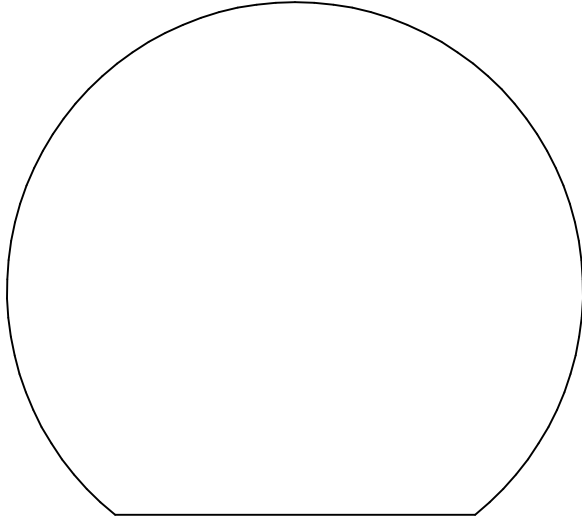

**KL 3906**  
2.671 x 3.000

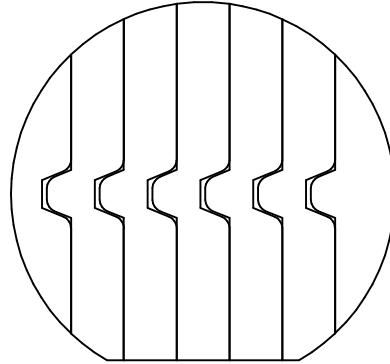

**KL 3907B**  
1.866 x 2.000

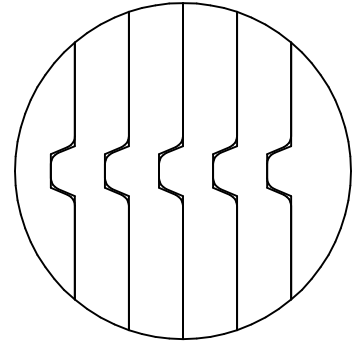

**KL 3913B**  
1.750 x 1.750

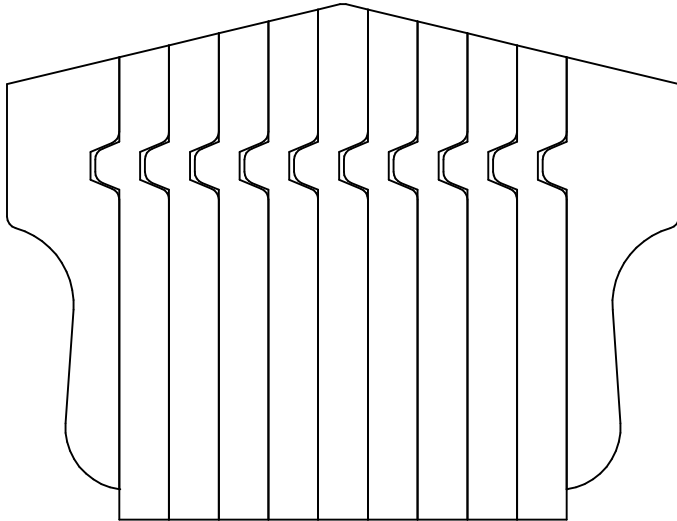

**KL 3908B**  
2.687 x 3.500

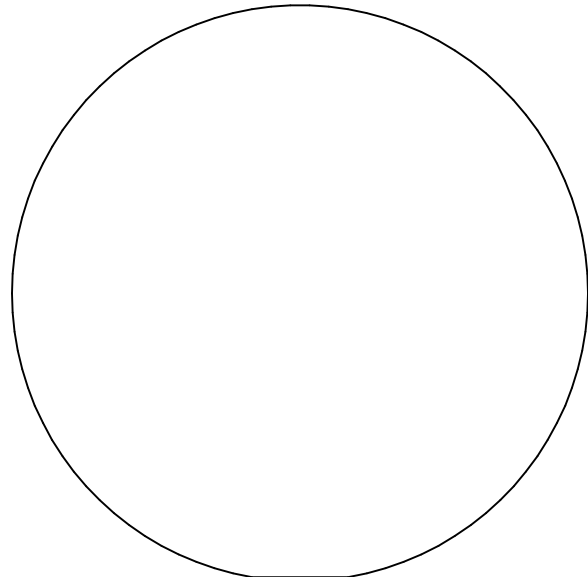

**KL 3909**  
2.979 x 3.000

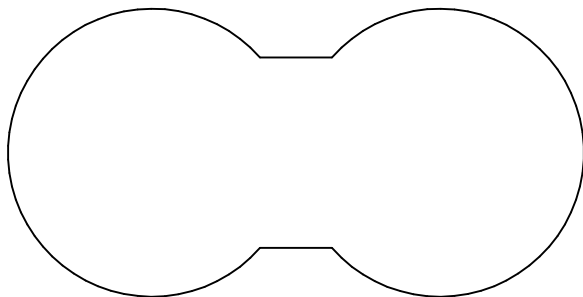

**KL 3911**  
1.500 x 3.000

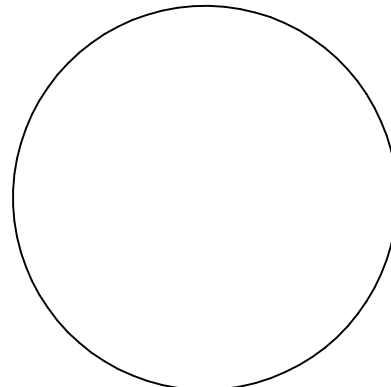

**KL 3912**  
2.000 x 2.000

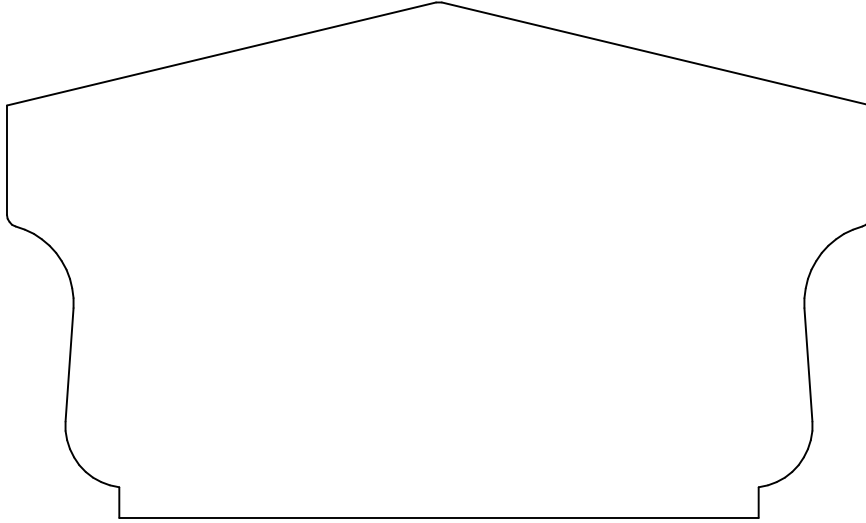

**KL 3908**  
2.687 x 4.500

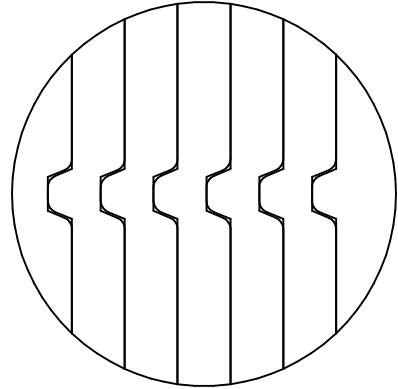

**KL 3912B**  
2.000 x 2.000

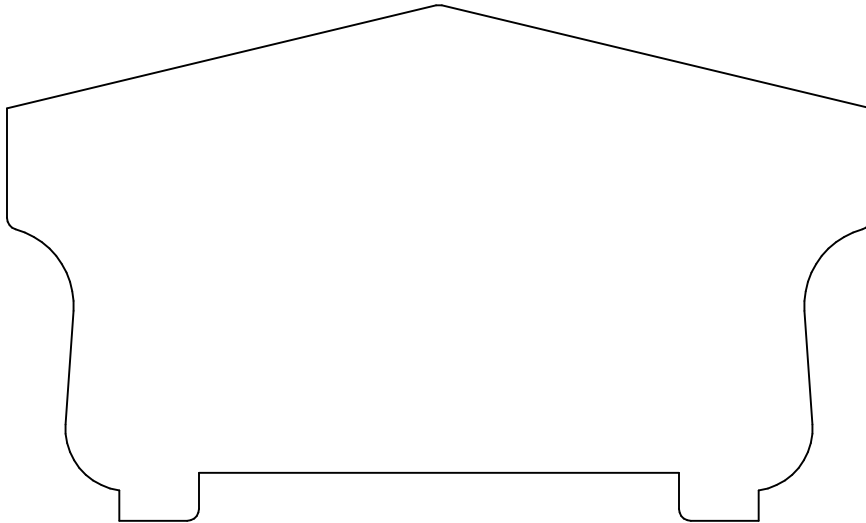

**KL 3908P**  
2.687 x 4.500

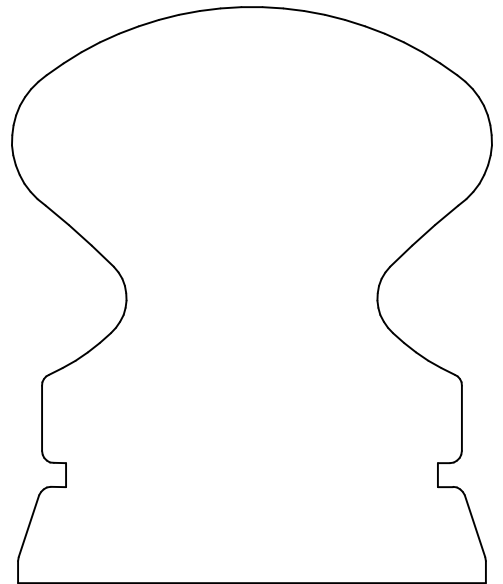

**KL 3922**  
3.000 x 2.500

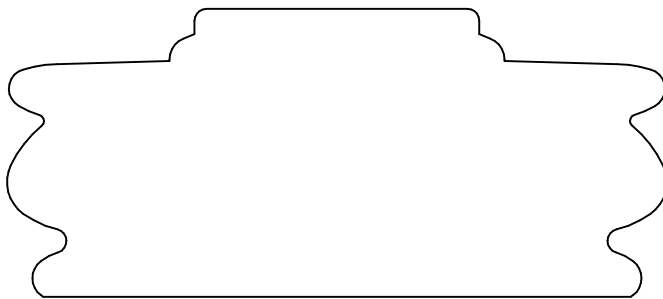

**KL 3915**  
1.500 x 3.437

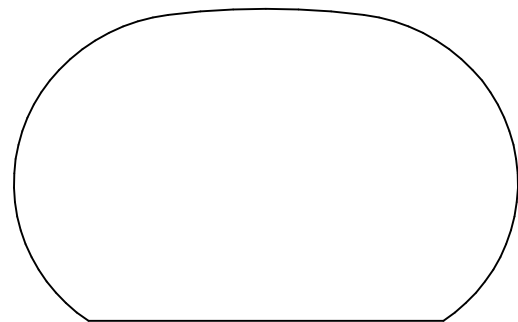

**KL 3917**  
1.625 x 2.625

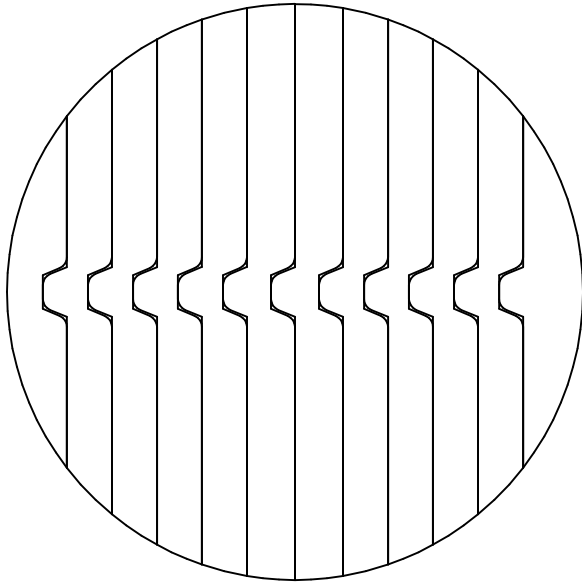

**KL 3909B**  
3.000 x 3.000

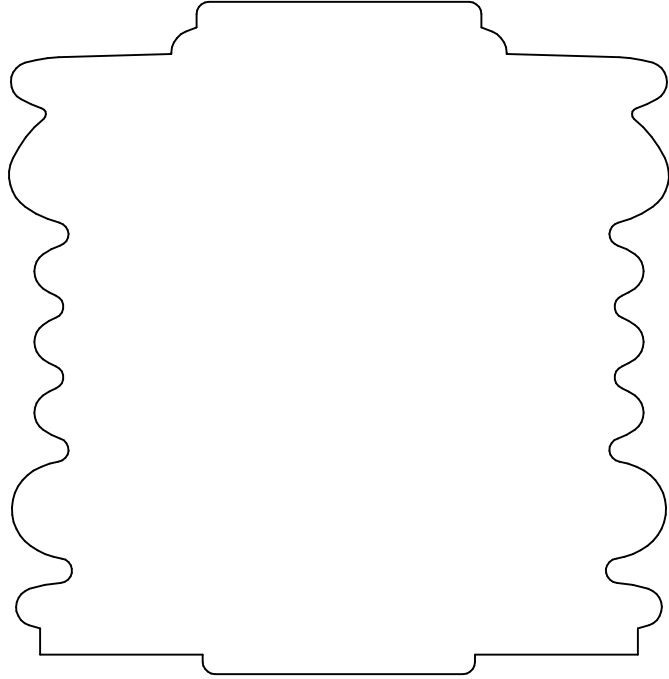

**KL 3914**  
3.500 x 3.437

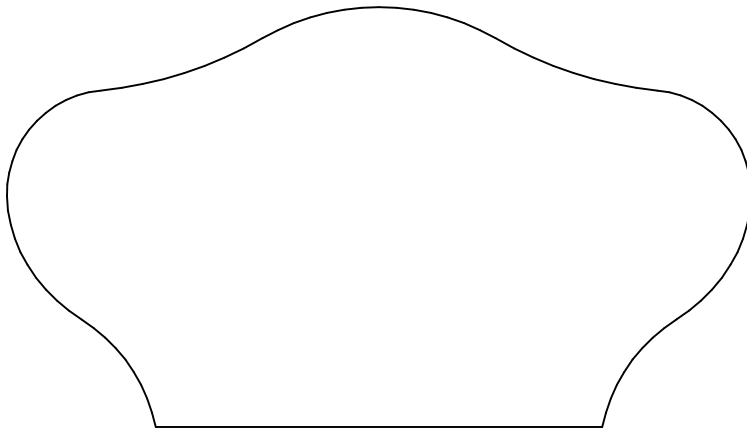

**KL 3916**  
2.187 x 3.875

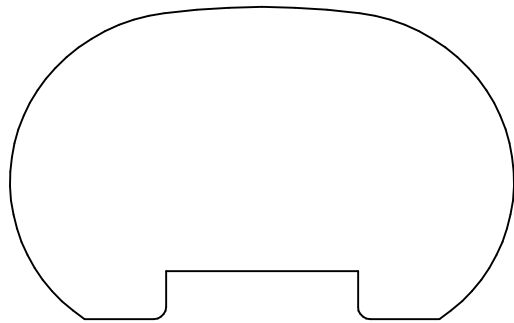

**KL 3917P**  
1.625 x 2.625

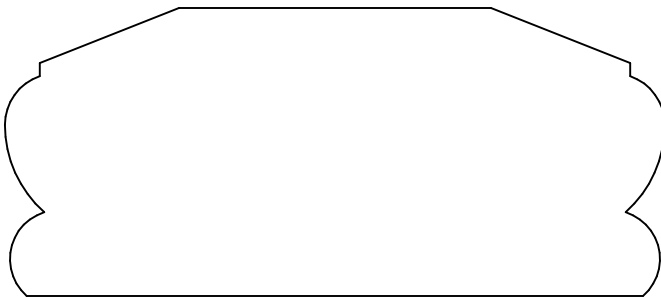

**KL 3918**  
1.500 x 3.437

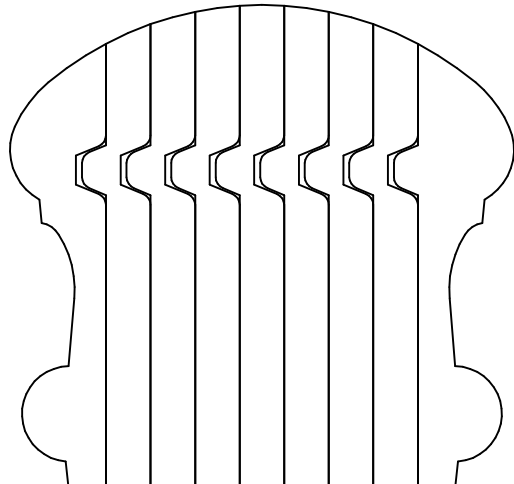

**KL 3921B**  
2.500 x 2.625

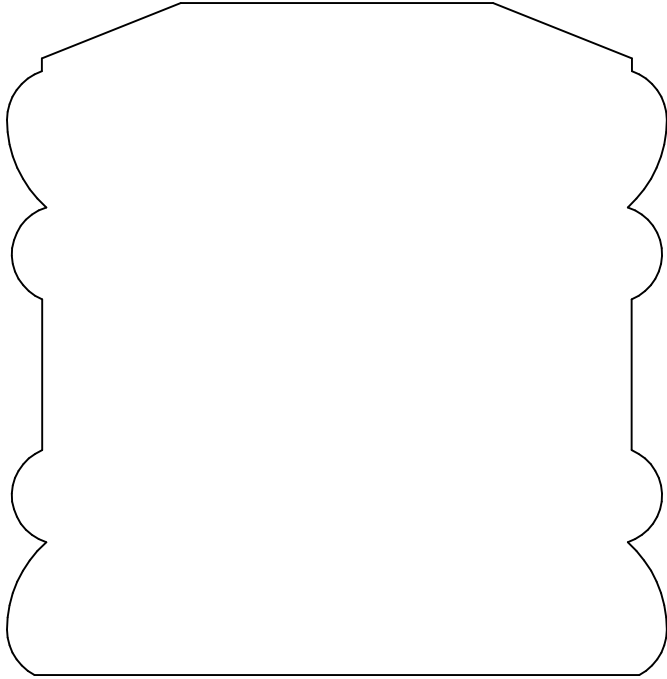

**KL 3919**  
3.500 x 3.437

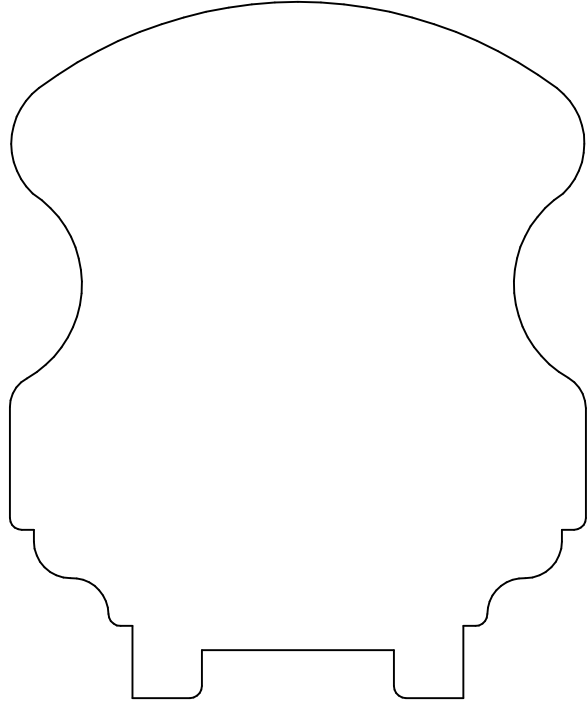

**KL 3920P**  
3.625 x 3.000

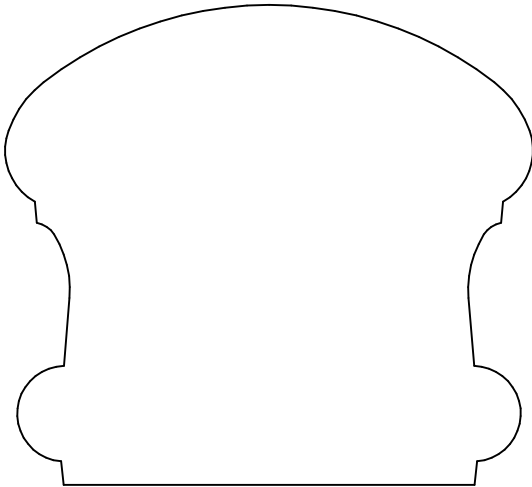

**KL 3921**  
2.500 x 2.750

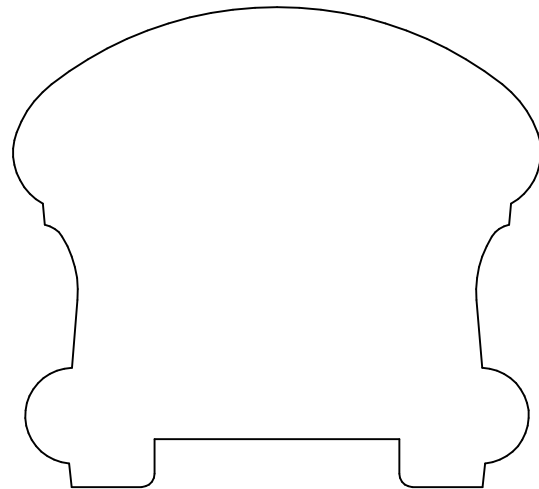

**KL 3921P**  
2.500 x 2.750

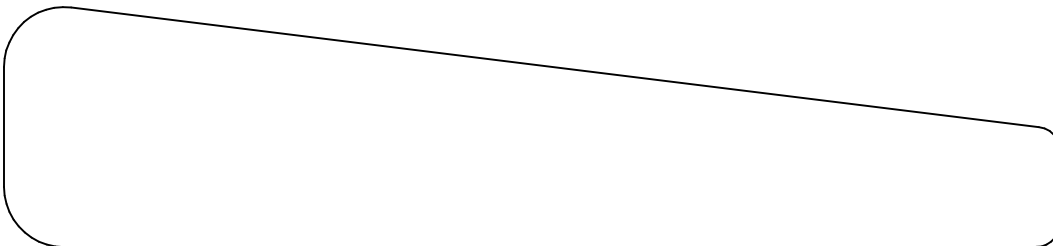

**KL 3924**  
1.250 x 5.500



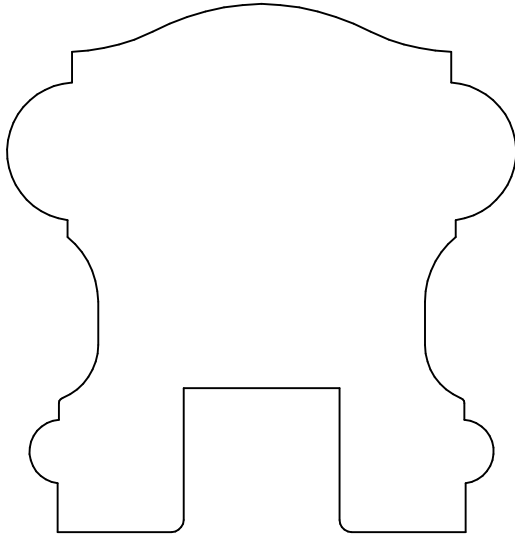

**KL3923P**  
2.750 x 2.651

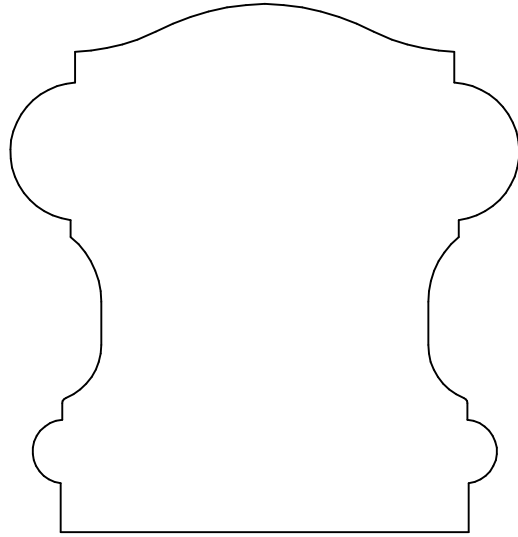

**KL 3923**  
2.750 x 2.651

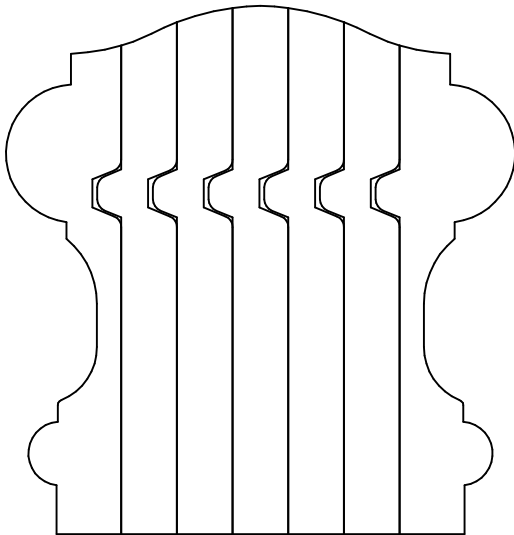

**KL 3923B**  
2.750 x 2.651

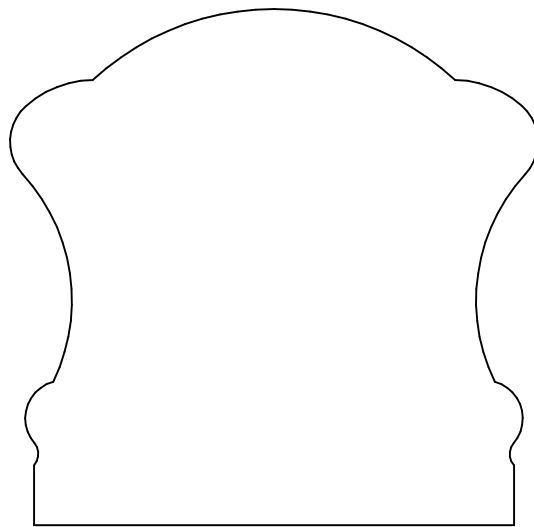

**KL 3925**  
2.688 x 2.750

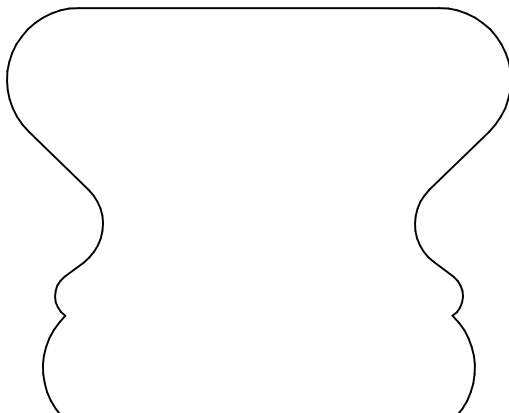

**KL 3926**  
2.125 x 2.625

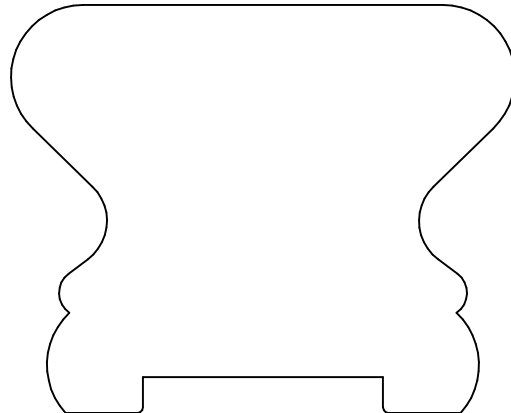

**KL 3926P**  
2.125 x 2.625

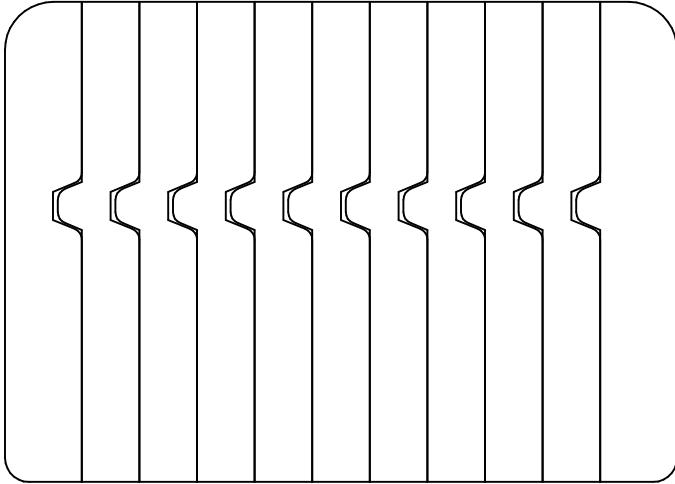

**KL 3927B**  
2.500 x 3.500

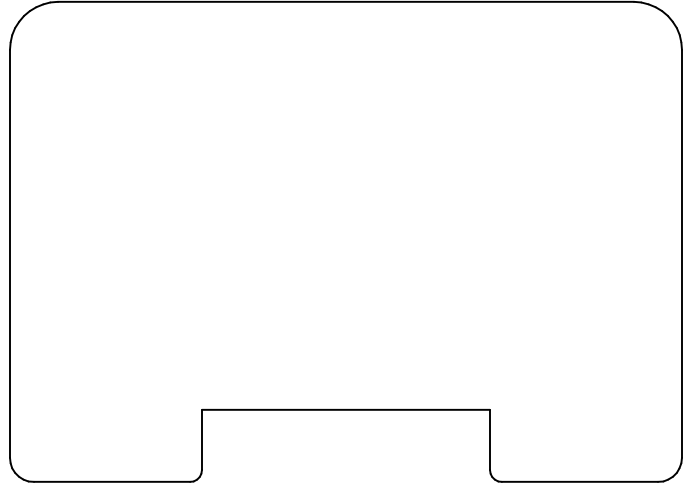

**KL 3927P**  
2.500 x 3.500

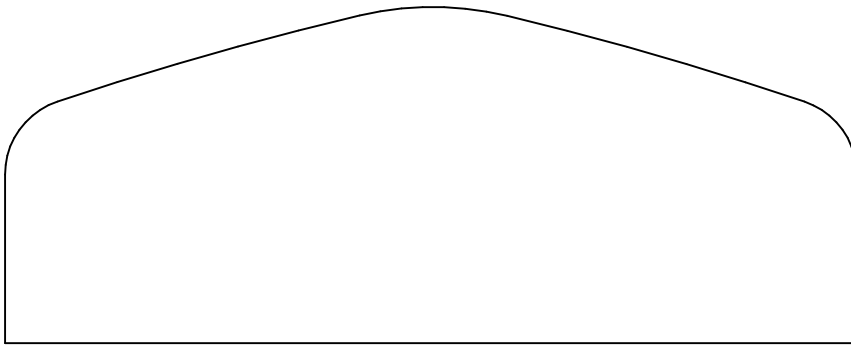

**KL 3928**  
1.750 x 4.437

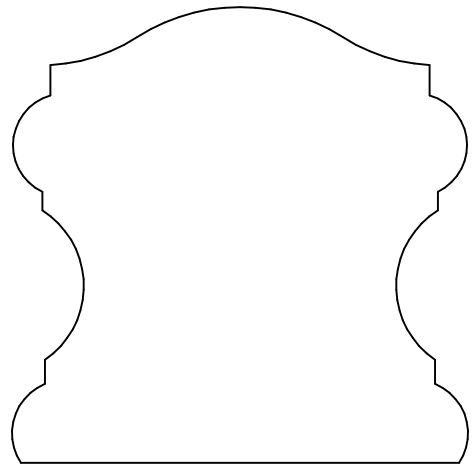

**KL 3935**  
2.375 x 2.375

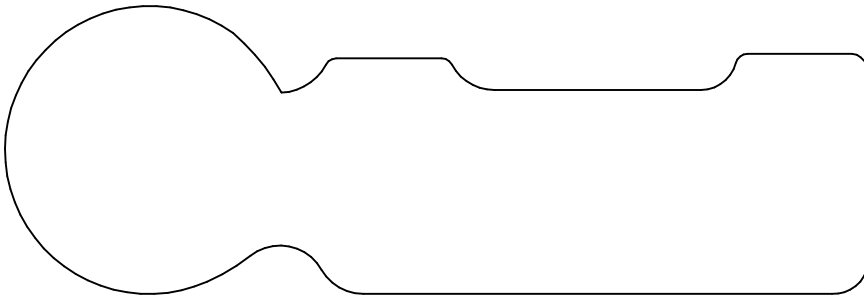

**KL 3929**  
1.500 x 4.500

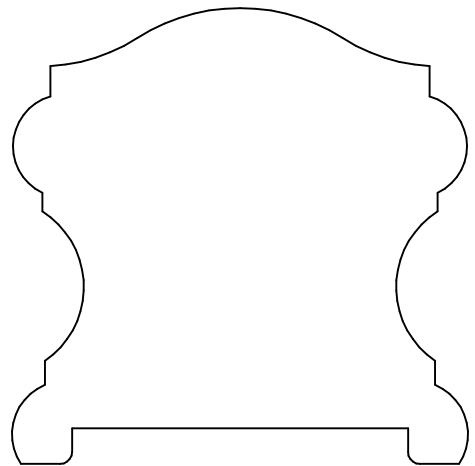

**KL 3935 P**  
2.375 x 2.375

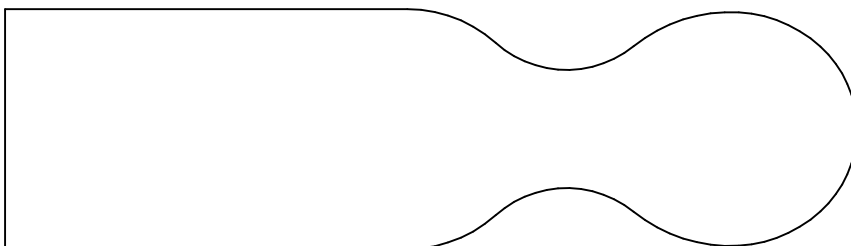

**KL 3932**  
1.250 x 4.437

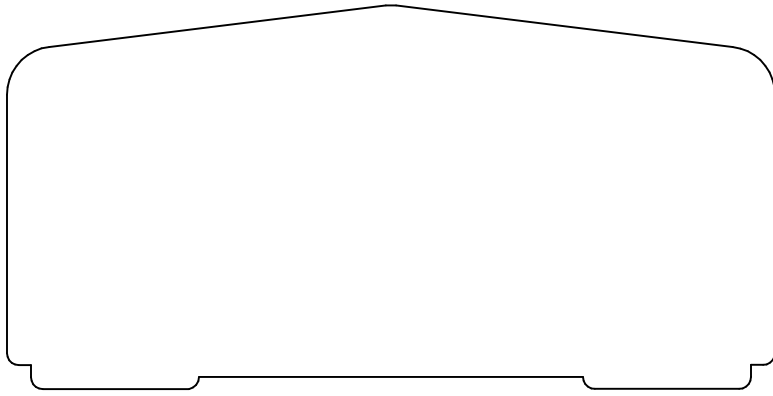

**KL 3930**  
2.000 x 4.000

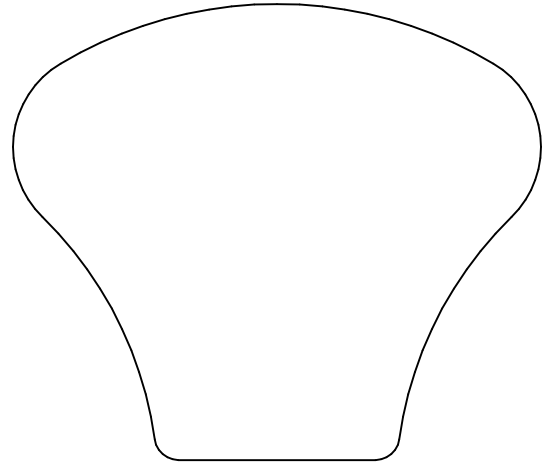

**KL 3933**  
2.375 x 2.750

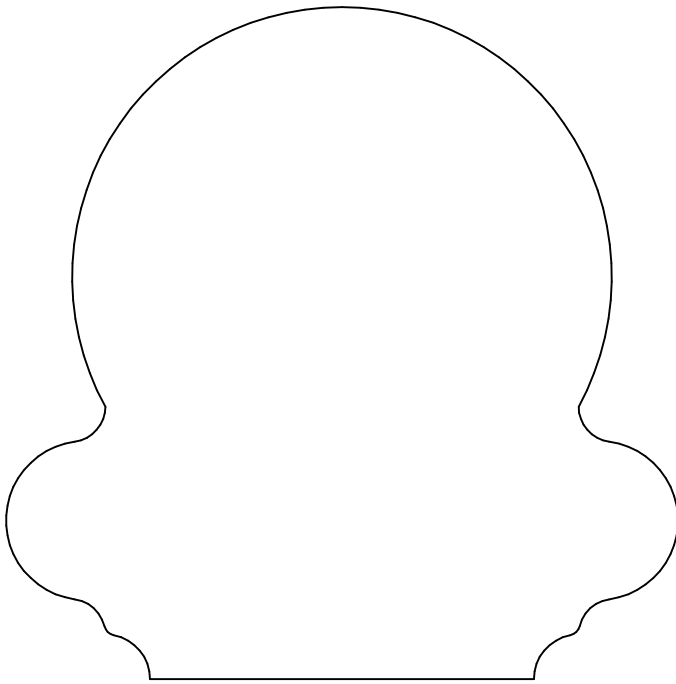

**KL 3931**  
3.500 x 3.500

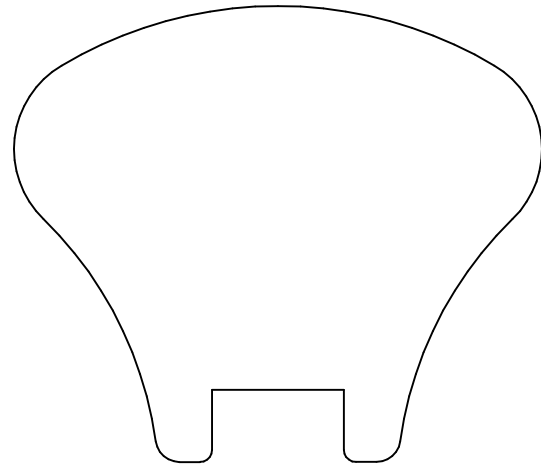

**KL 3933P**  
2.375 x 2.750

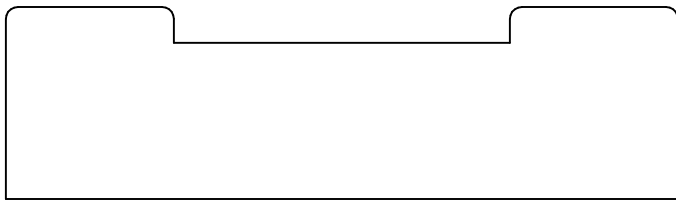

**KL 3934P**  
1.000 x 3.500

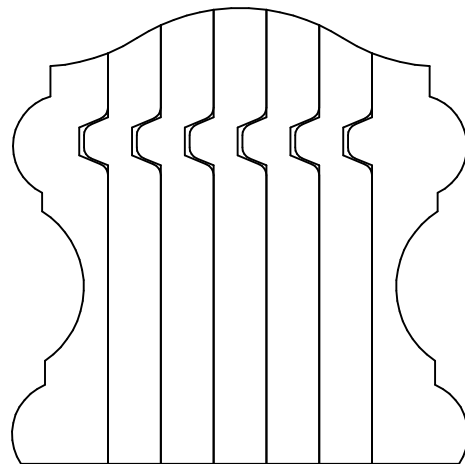

**KL 3935B**  
2.375 x 2.375

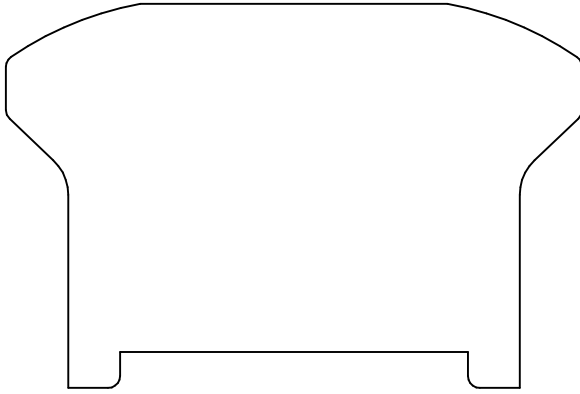

**KL 3936P**  
2.000 x 3.000

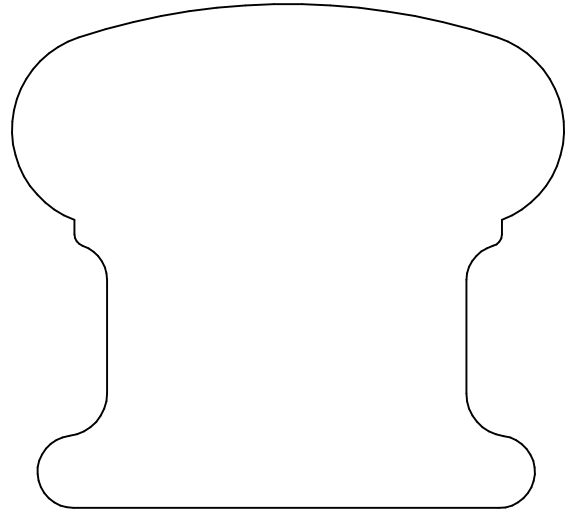

**KL 3937**  
2.625 x 2.875

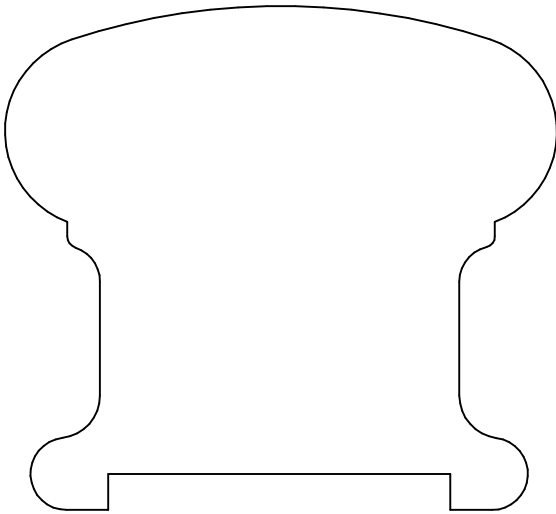

**KL 3937P**  
2.625 x 2.875

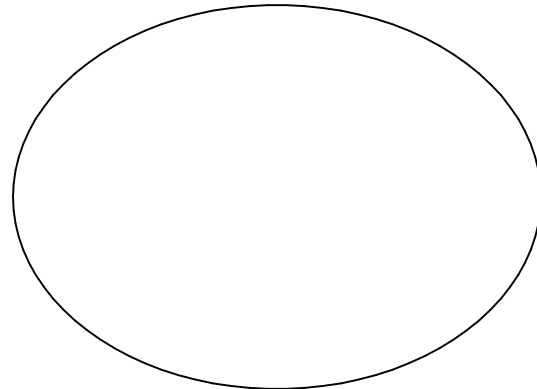

**KL 3938**  
2.000 x 2.750

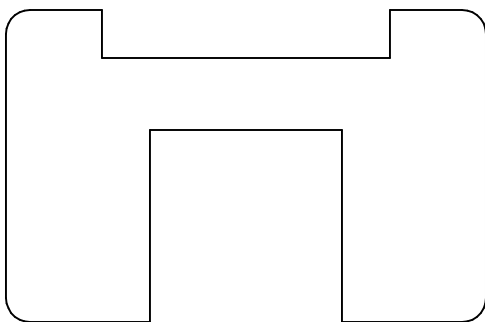

**KL 3939P**  
1.625 x 2.500

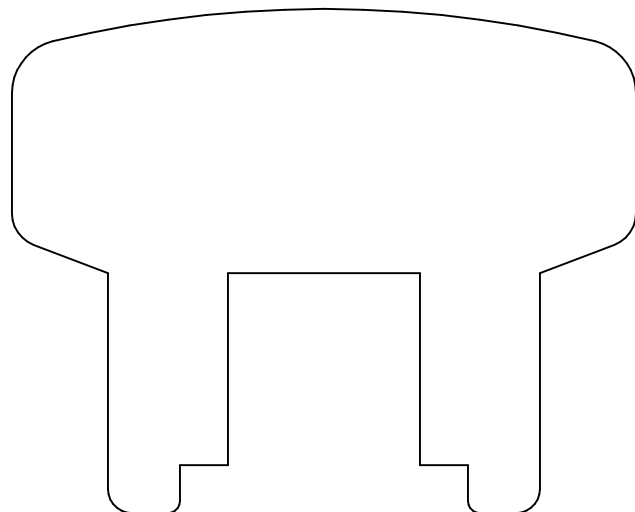

**KL 3940P**  
2.625 x 3.250

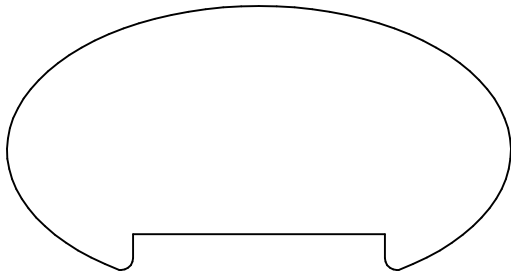

**KL 3941P**  
1.375 x 2.625

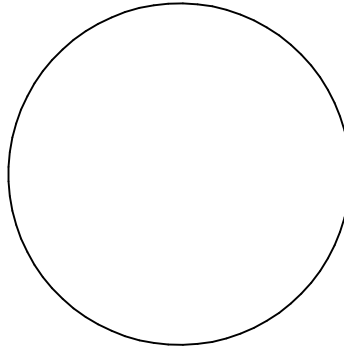

**KL 3942**  
1.78 x 1.78

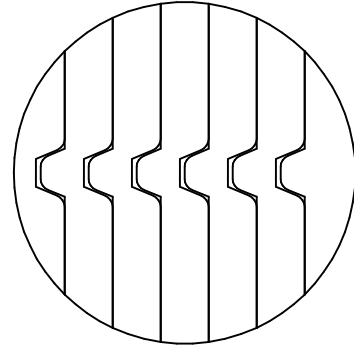

**KL 3942B**  
1.78 x 1.78

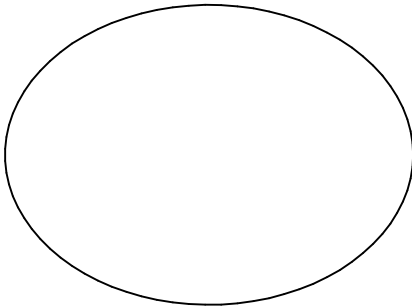

**KL 3943**  
1.562 x 2.125

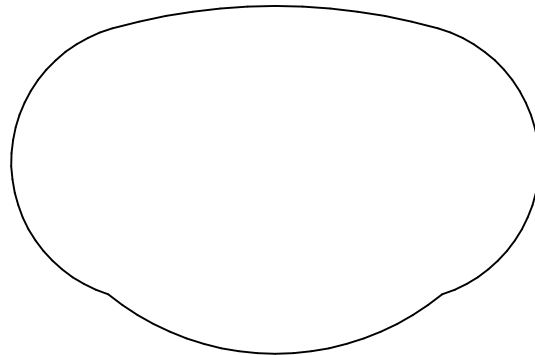

**KL 3944**  
1.812 x 2.750

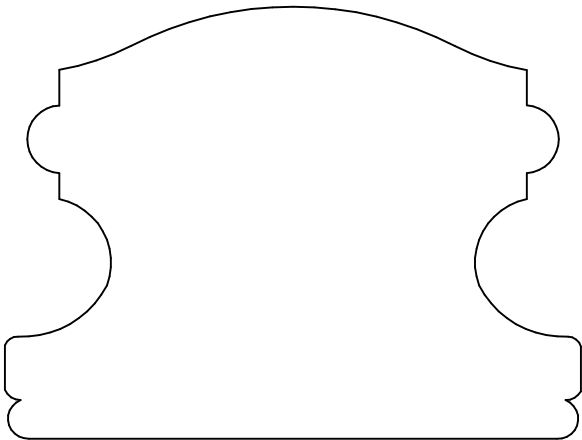

**KL 3945**  
2.250 x 3.000

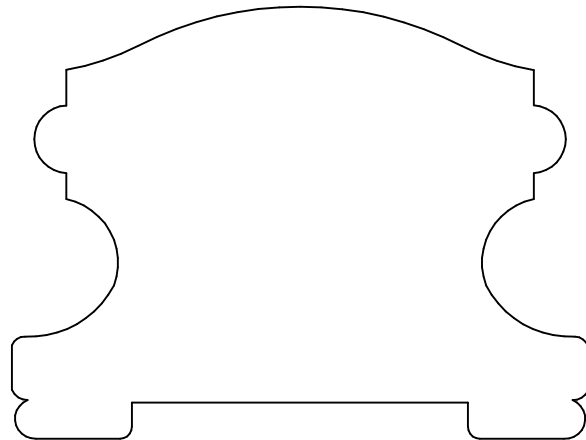

**KL 3945P**  
2.250 x 3.000

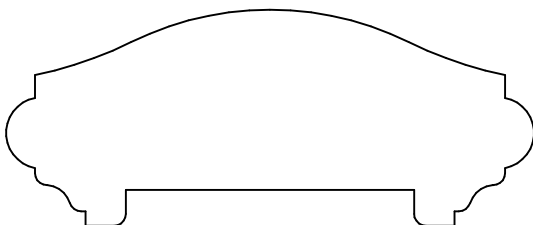

**KL 3946P**  
1.125 x 2.750

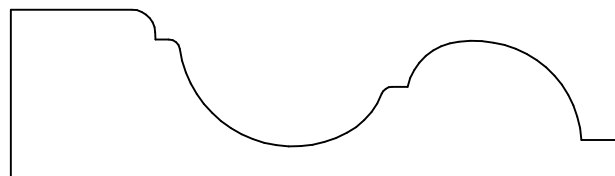

**KL 3953**  
.875 x 3.156

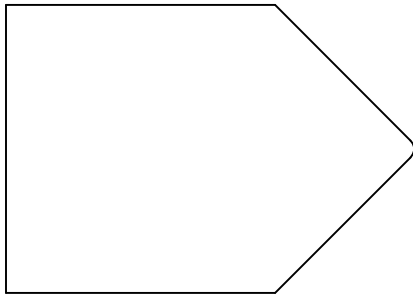

**KL 3947**  
1.500 x 2.125

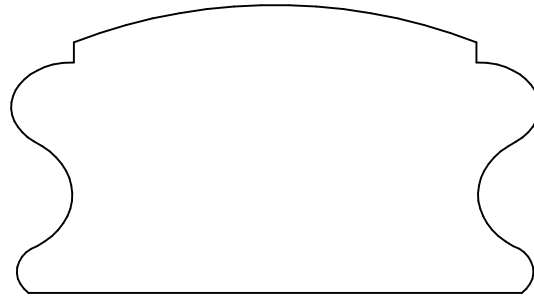

**KL 3948**  
1.500 x 2.750

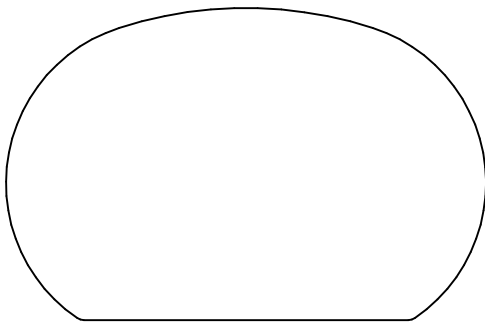

**KL 3949**  
1.625 x 2.500

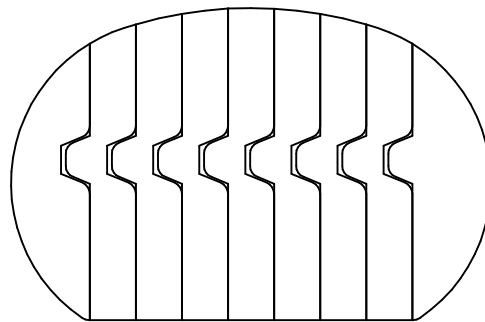

**KL 3949B**  
1.625 x 2.500

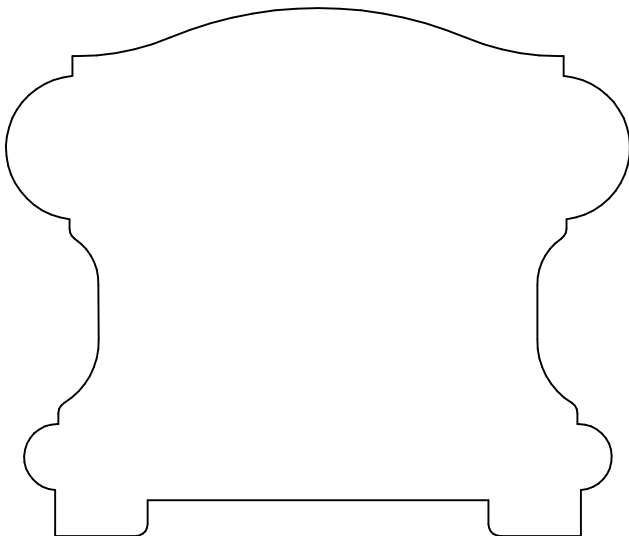

**KL 3950P**  
2.750 x 3.250

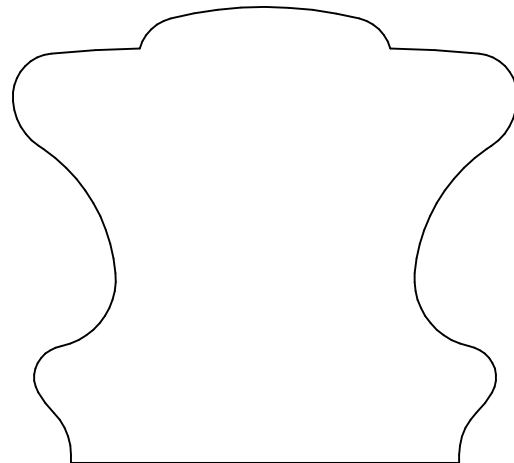

**KL 3951**  
2.375 x 2.625

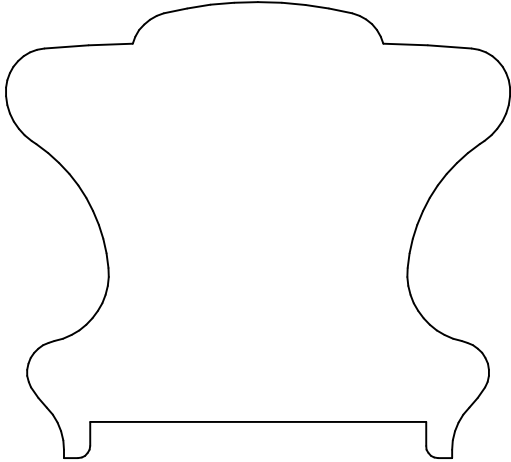

**KL 3951P**  
2.375 x 2.625

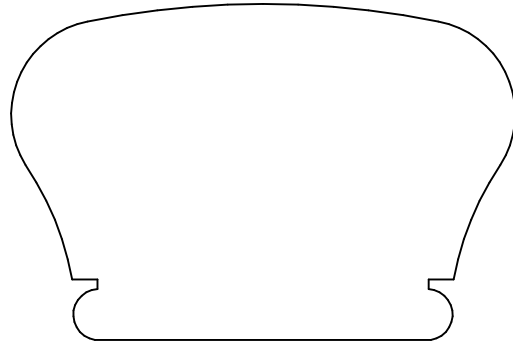

**KL 3955**  
1.750 x 2.625

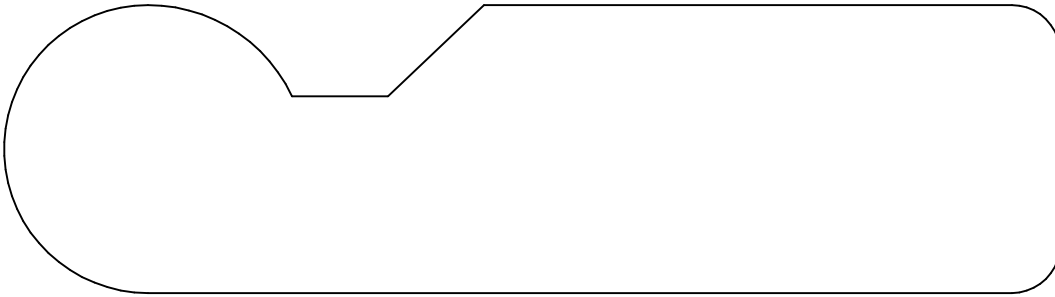

**KL 3952**  
1.500 x 5.500

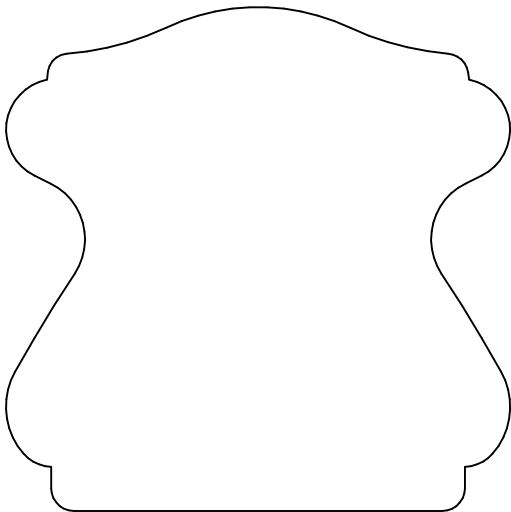

**KL 3954**  
2.625 x 2.625

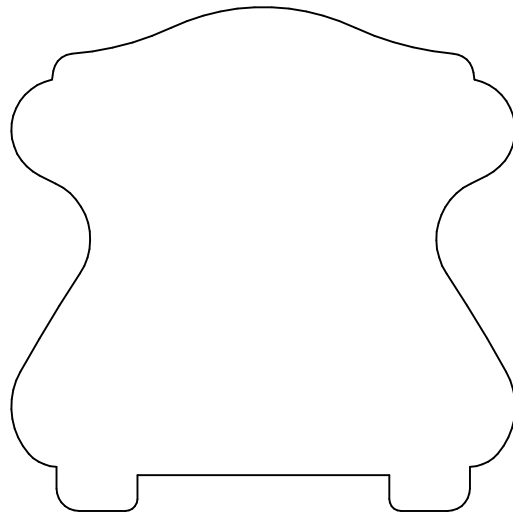

**KL 3954P**  
2.625 x 2.625

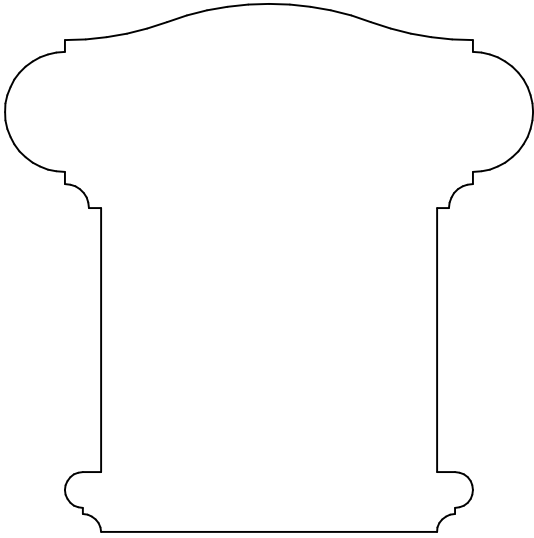

**KL 3956**  
2.750 x 2.750

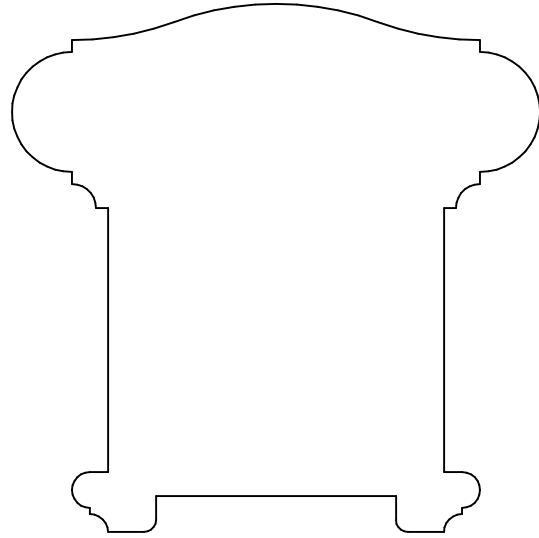

**KL 3956P**  
2.750 x 2.750



**KL 3957P**  
1.375 x 5.375

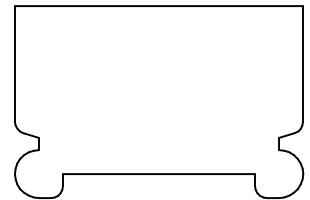

**KL 3963P**  
1.000 x 1.500

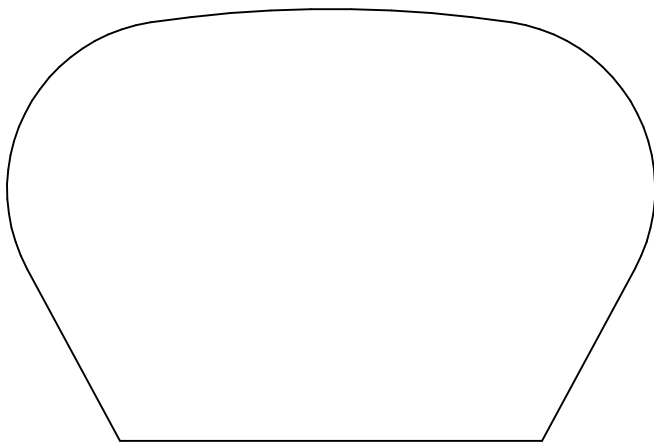

**KL 3958**  
2.250 x 3.375

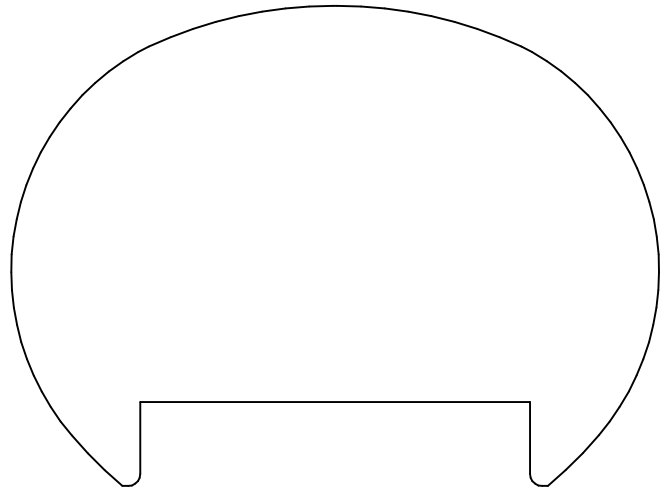

**KL 3960P**  
2.500 x 3.375



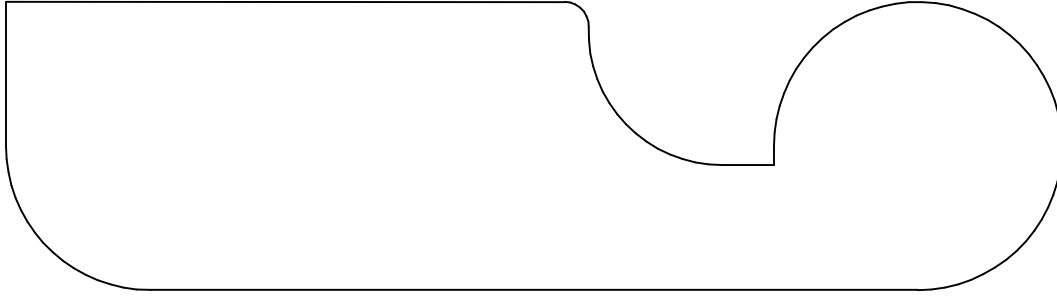

**KL 3959**  
1.500 x 5.500

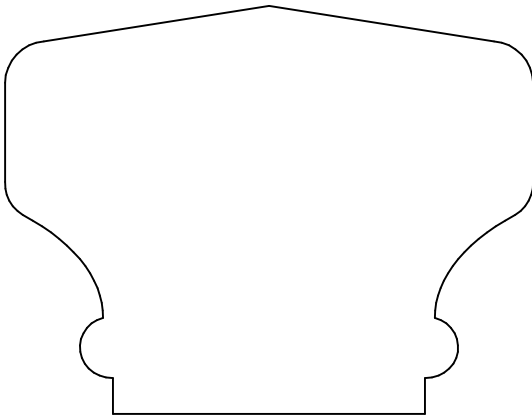

**KL 3961**  
2.125 x 2.750

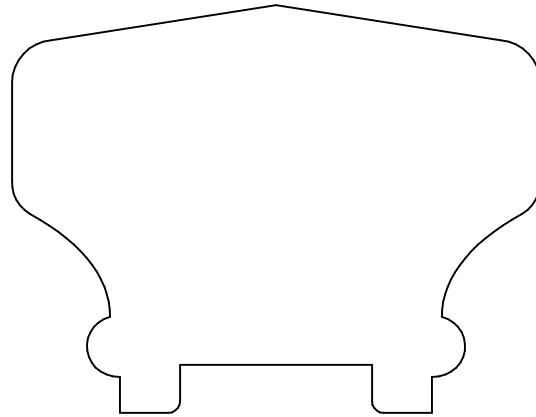

**KL 3961P**  
2.125 x 2.750

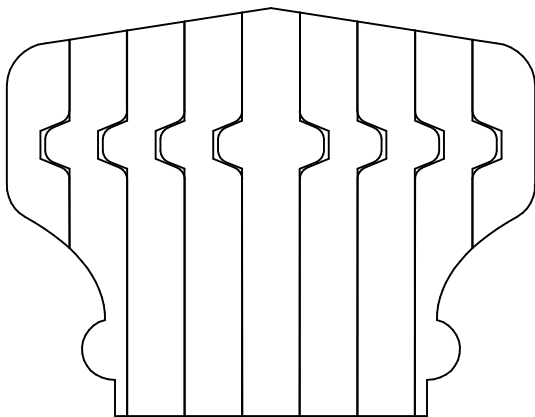

**KL 3961B**  
2.125 x 2.750

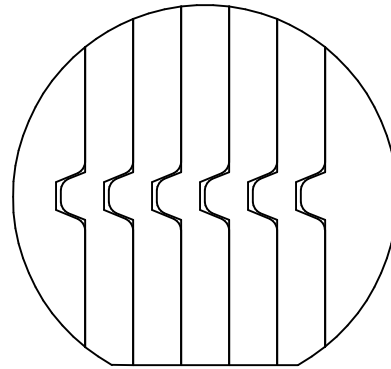

**KL 3962B**  
1.875 x 2.000

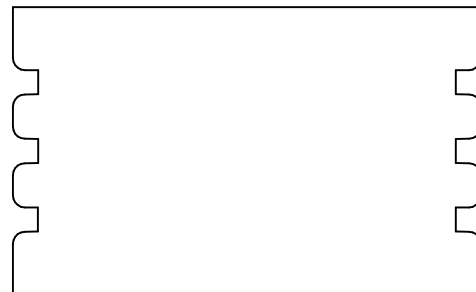

**KL 3966**  
1.500 x 2.437

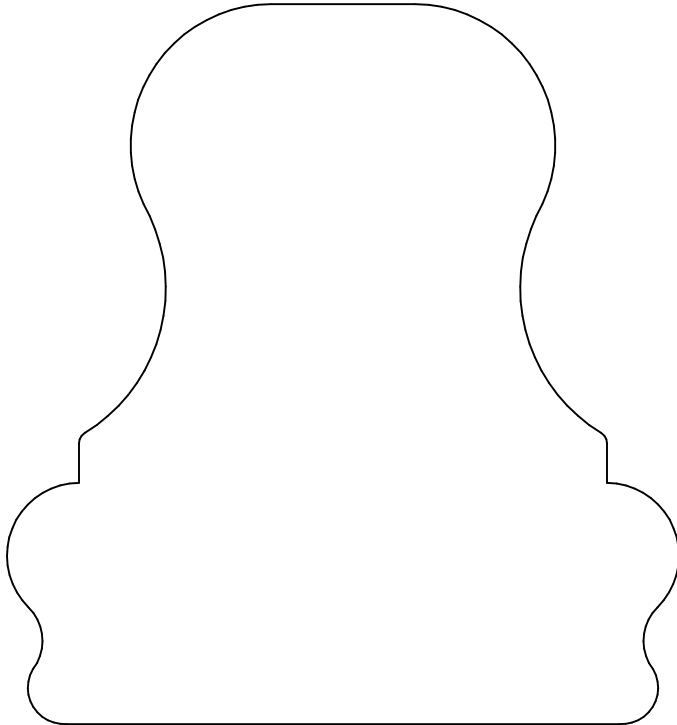

**KL 3964**  
3.750 x 3.500

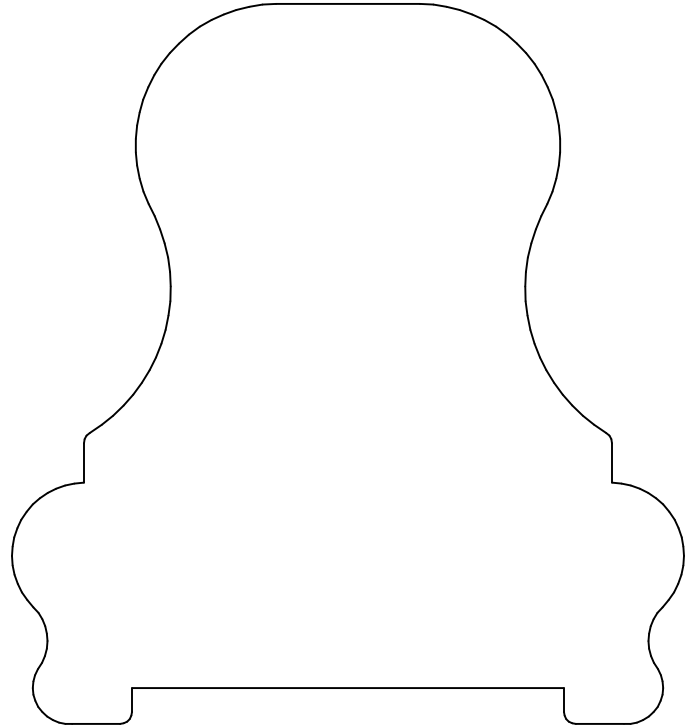

**KL 3964P**  
3.750 x 3.500

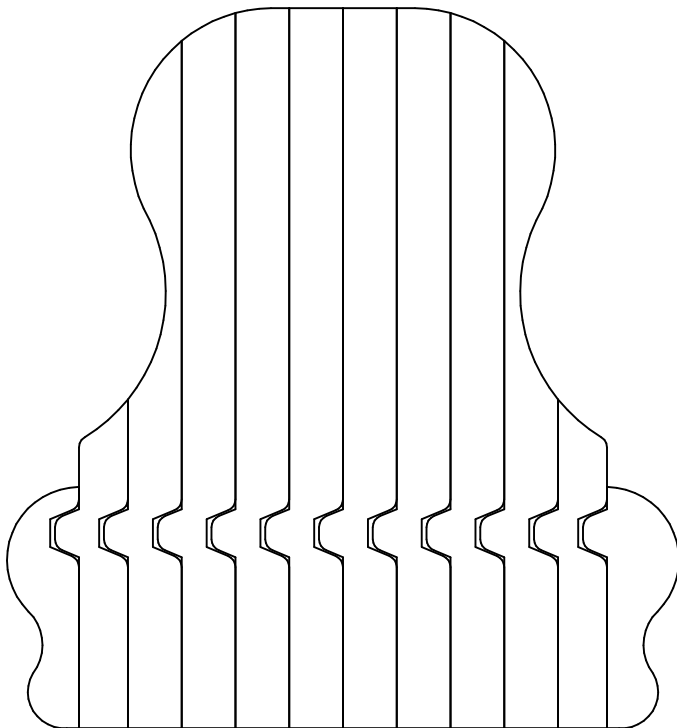

**KL 3964B**  
3.750 x 3.500

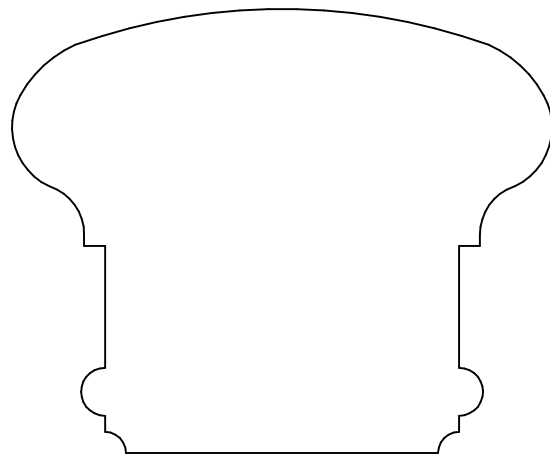

**KL 3969**  
2.312 x 2.813

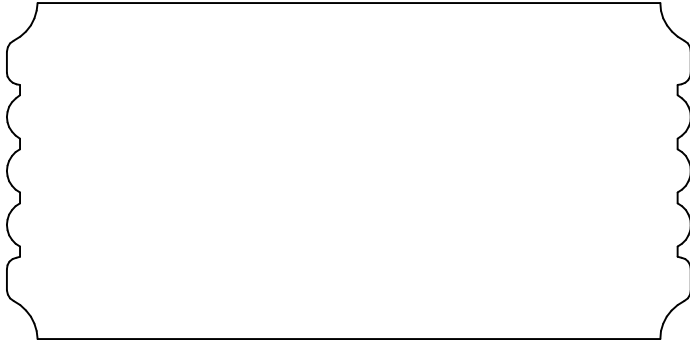

**KL 3965**  
1.750 x 3.562

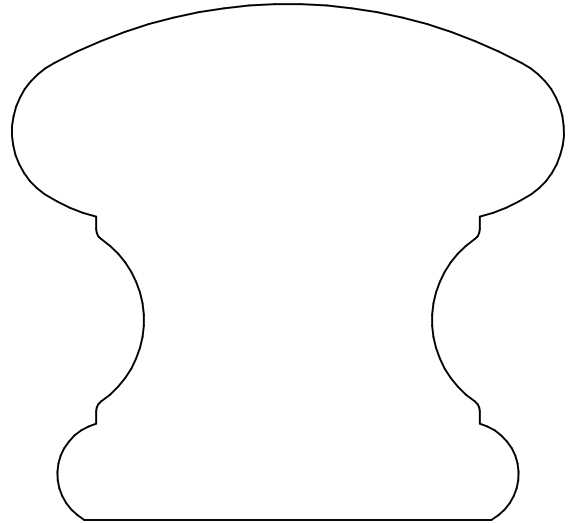

**KL 3975**  
2.687 x 2.875

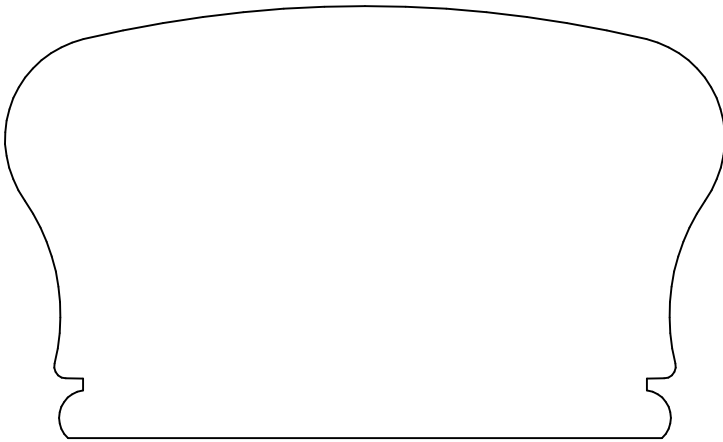

**KL 3967**  
2.250 x 3.750

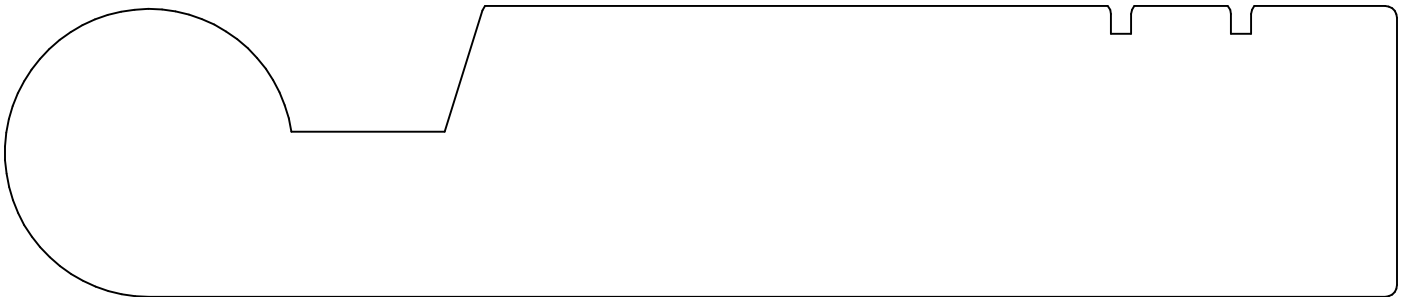

**KL 3968**  
1.515 x 7.250

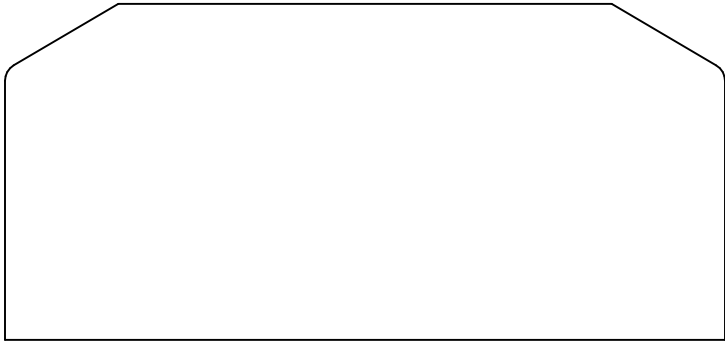

**KL 3970**  
1.750 x 3.750

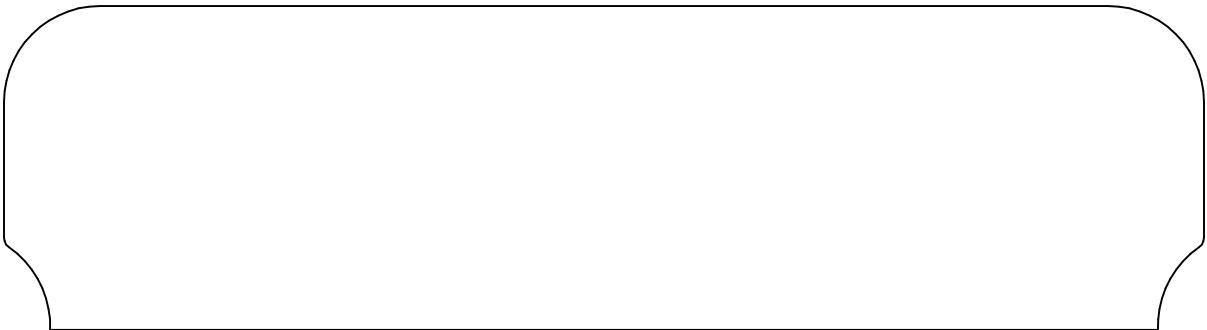

**KL 3972**  
1.687 x 6.250

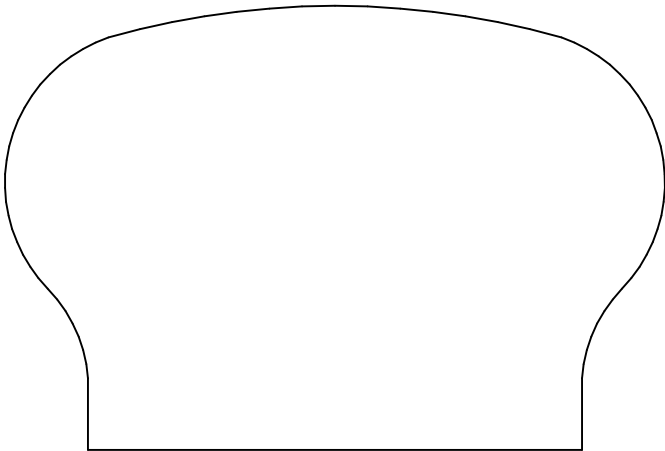

**KL 3973**  
2.312 x 3.437

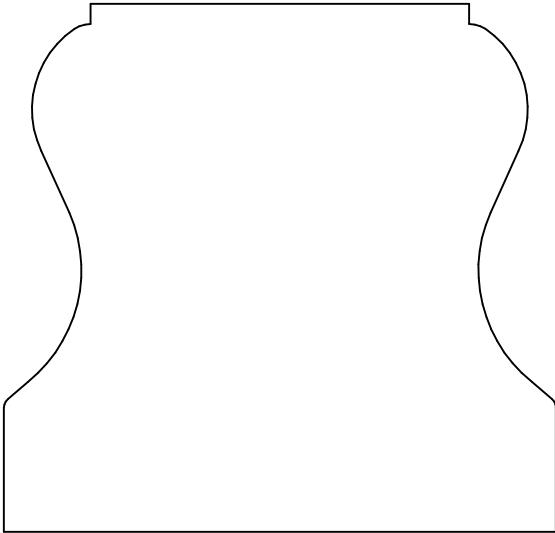

**KL 3976**  
2.750 x 2.875

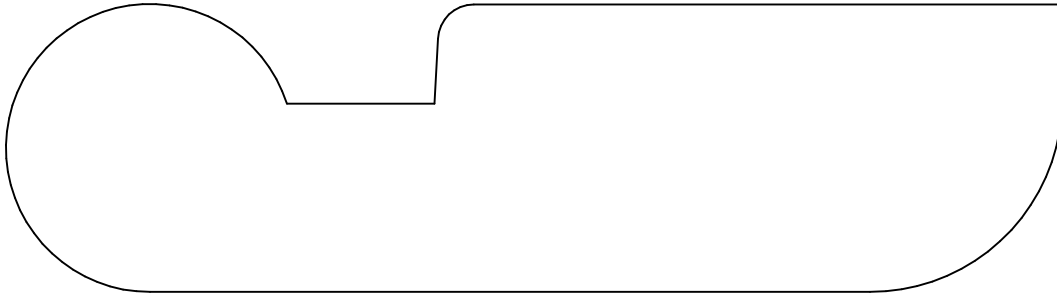

**KL 3974**  
1.500 x 5.500

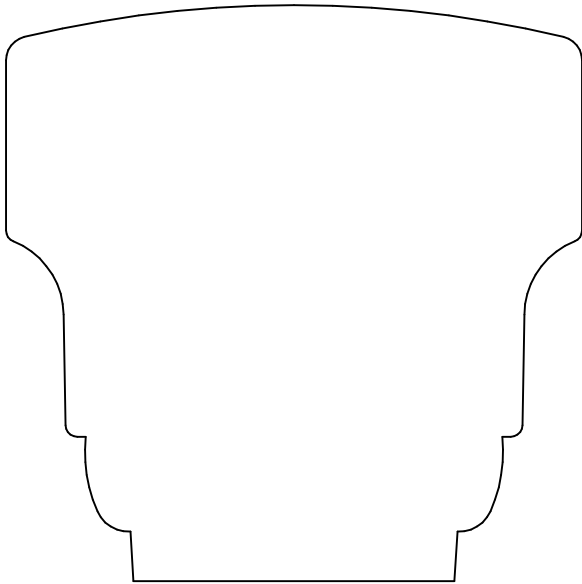

**KL 3977**  
3.000 x 3.000

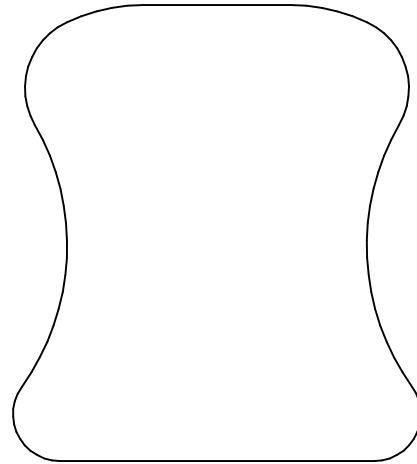

**KL 3978**  
2.375 x 2.125

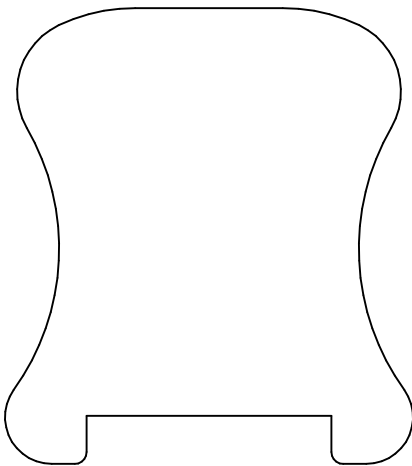

**KL 3978P**  
2.375 x 2.125

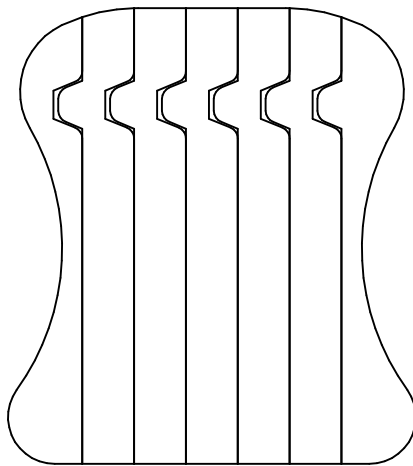

**KL 3978B**  
2.375 x 2.125

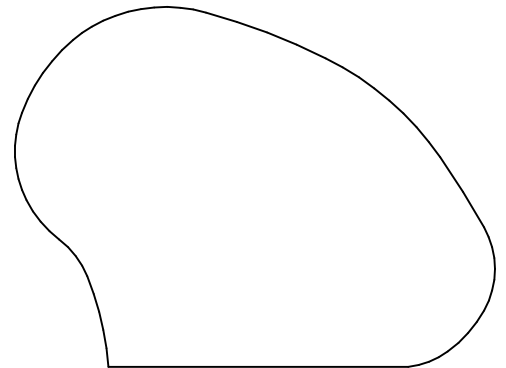

**KL 3984**  
1.875 x 2.500

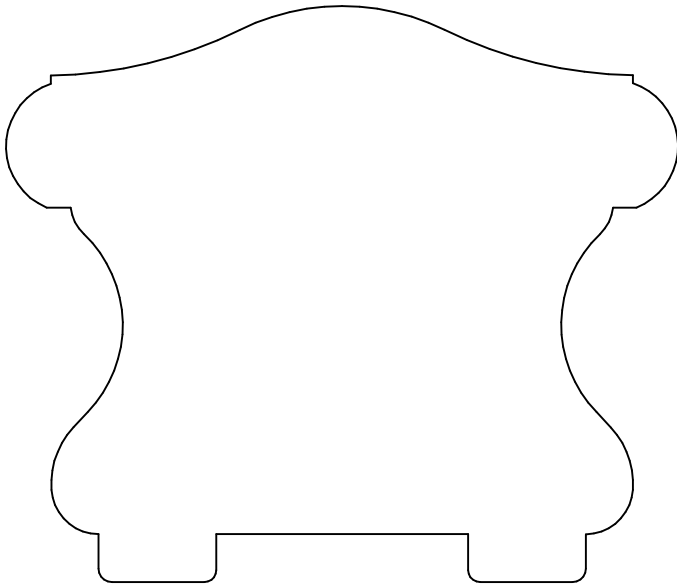

**KL 3979P**  
3.000 x 3.500

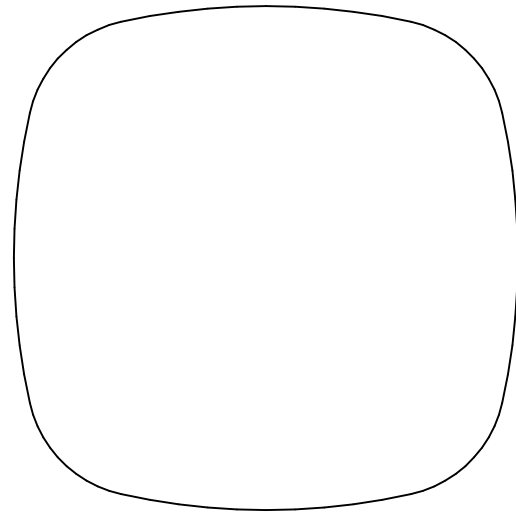

**KL 3981**  
2.625 x 2.625

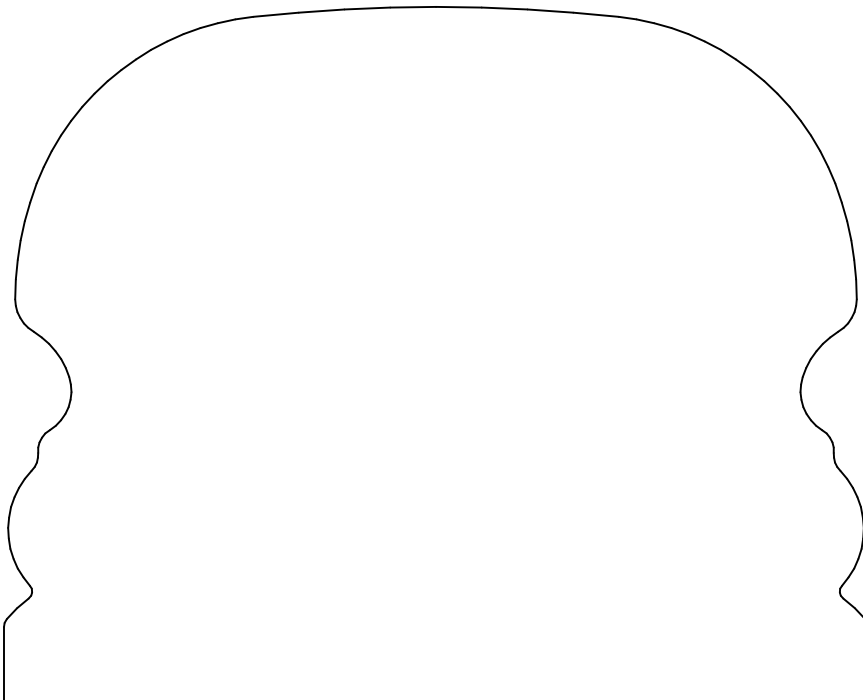

**KL 3980**  
3.625 x 4.500

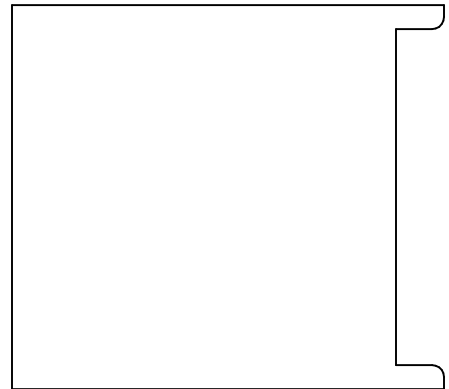

**KL 3993P**  
2.000 x 2.250



**KL 3996**  
.875 x 2.250

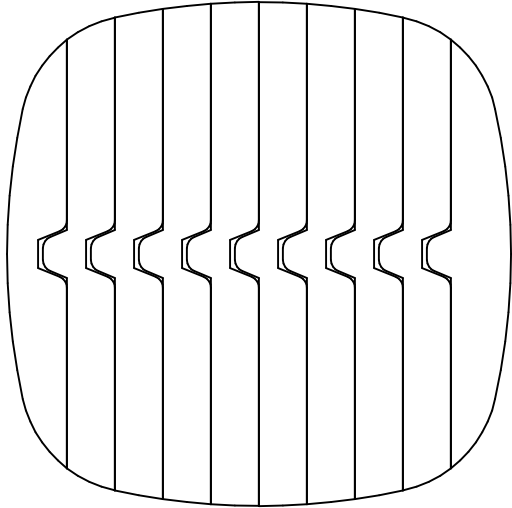

**KL 3981B**  
2.625 x 2.625

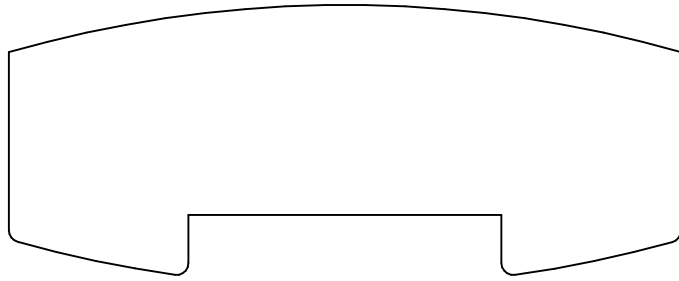

**KL 3982P**  
1.406 x 3.500

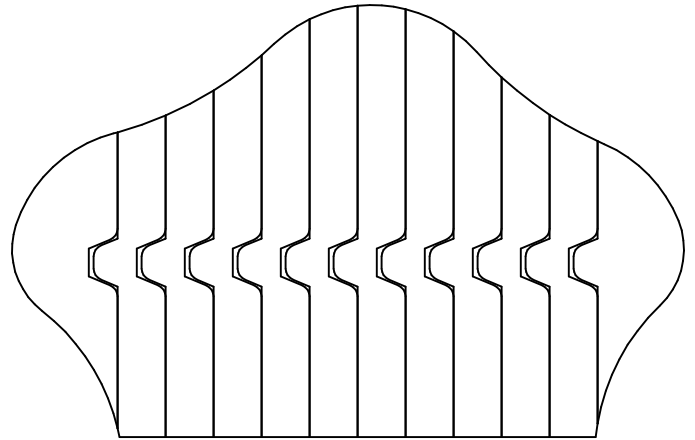

**KL 3983B**  
2.250 x 3.500

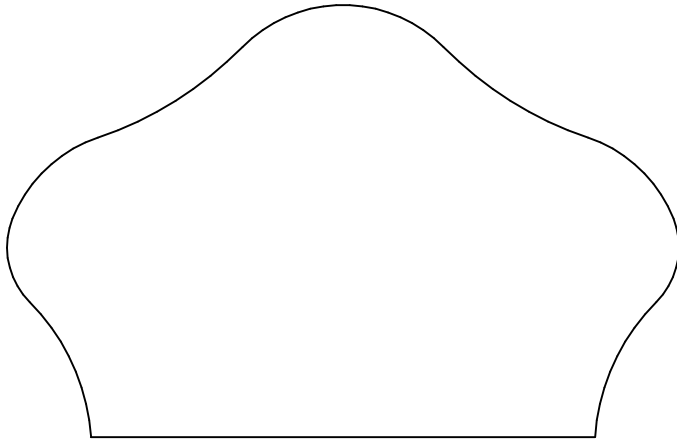

**KL 3983**  
2.250 x 3.500

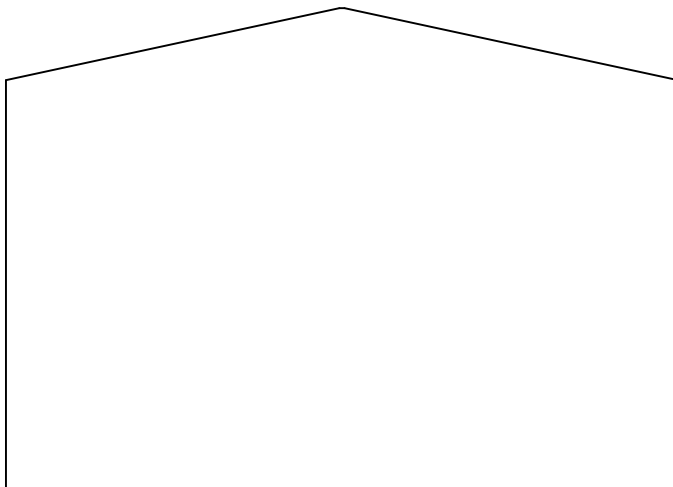

**KL 3986**  
2.500 x 3.500

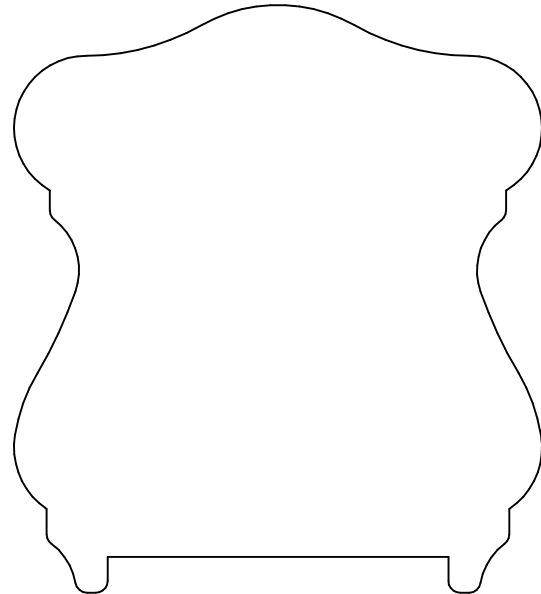

**KL 3985P**  
3.062 x 2.750

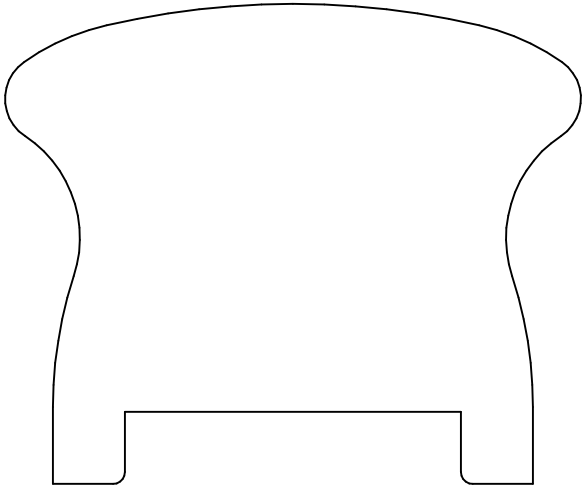

**KL 3988P**  
2.500 x 3.000

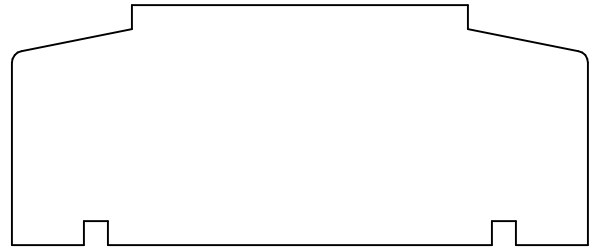

**KL 3989**  
1.250 x 3.000

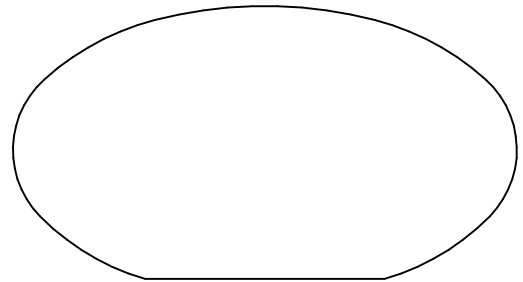

**KL 3991**  
1.421 x 2.625

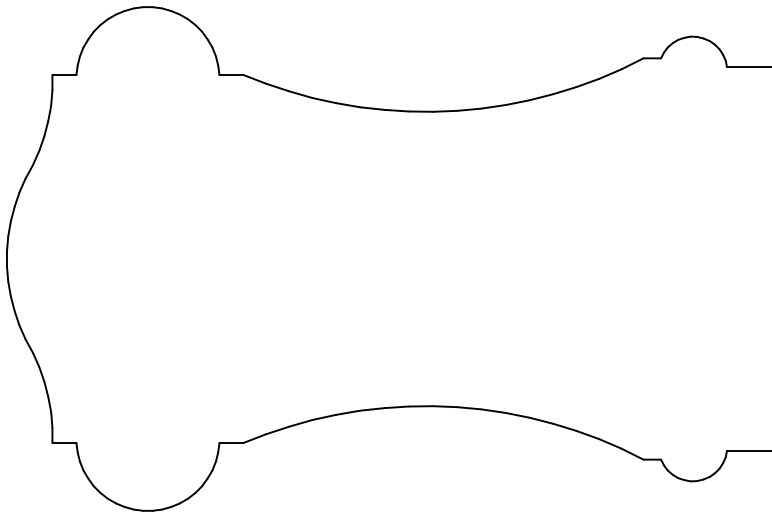

**KL 3990**  
4.000 x 2.625

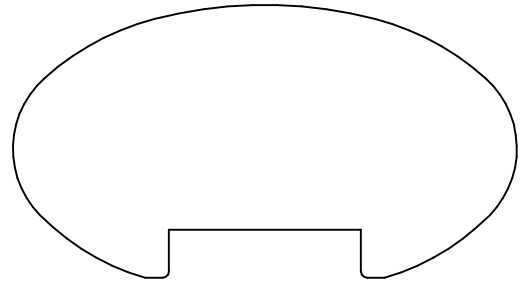

**KL 3991P**  
1.421 x 2.625



**KL 3992P**  
2.000 x 4.500

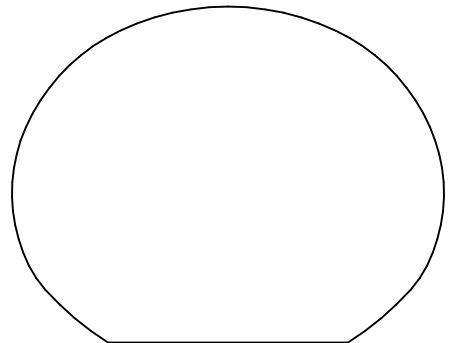

**KL 3999**  
1.750 x 2.250



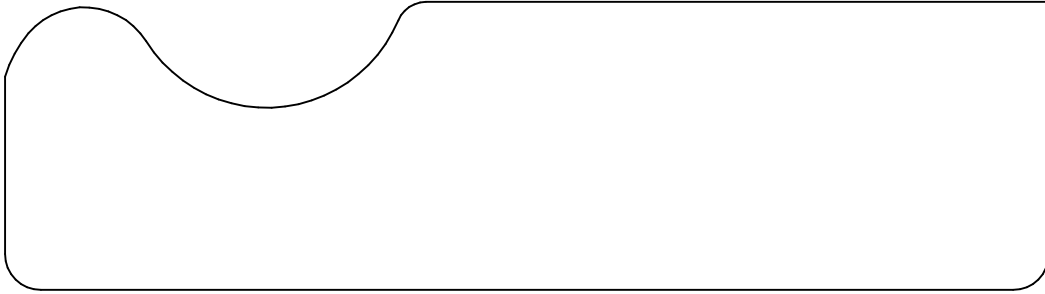

**KL 3994**  
1.500 x 5.437

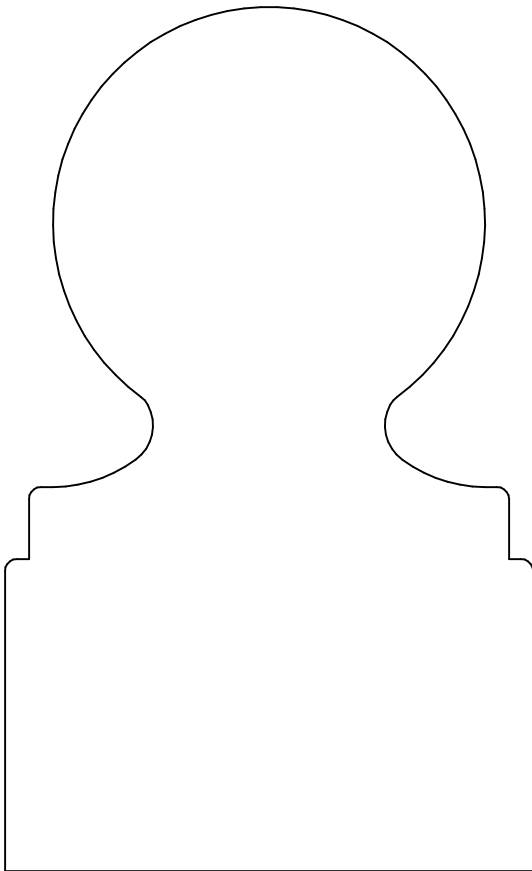

**KL 3995**  
4.500 x 2.750

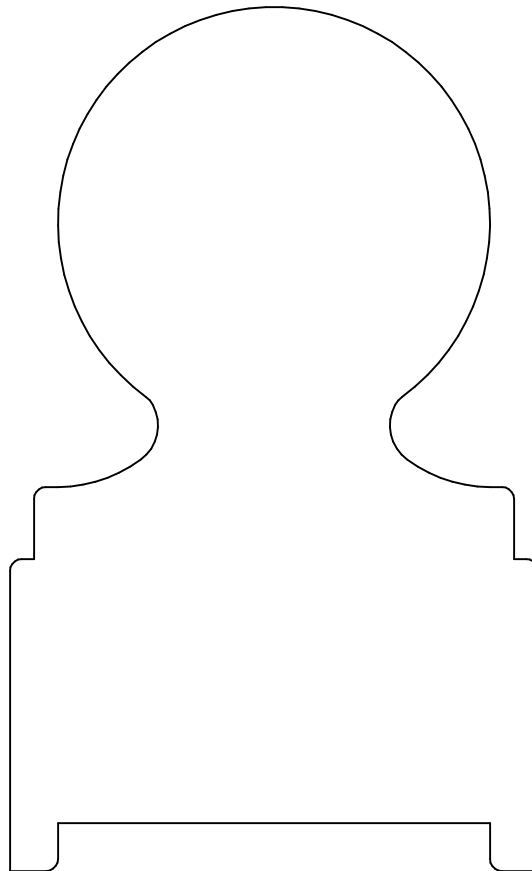

**KL 3995P**  
4.500 x 2.750

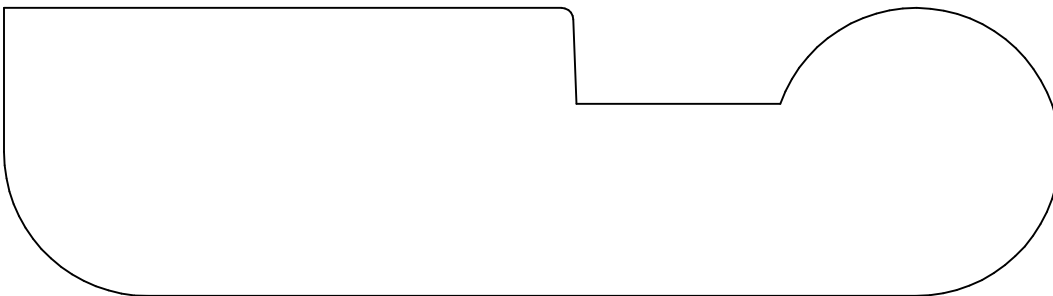

**KL 3997**  
1.500 x 5.500

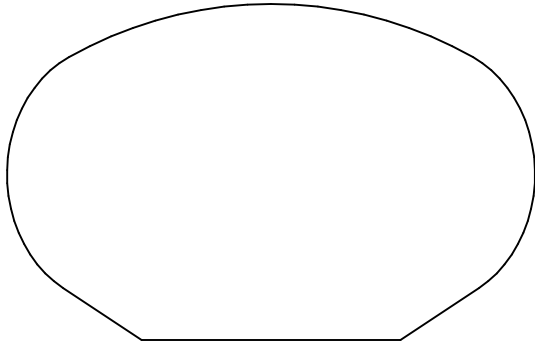

**KL 3998**  
1.750 x 2.750

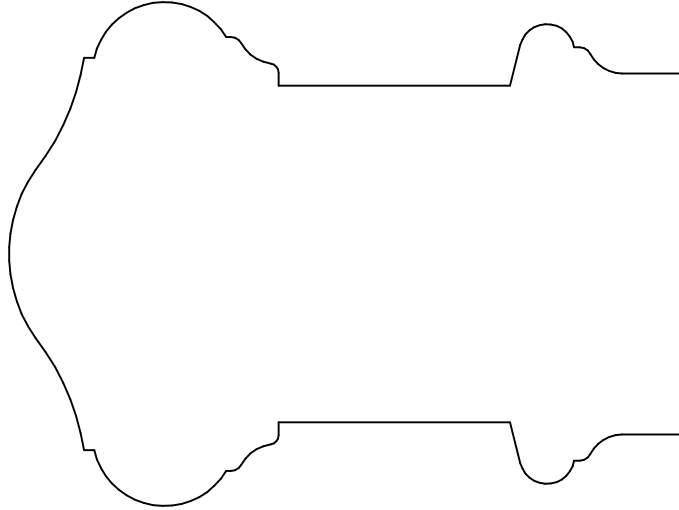

**KL 4900**  
3.500 x 2.625

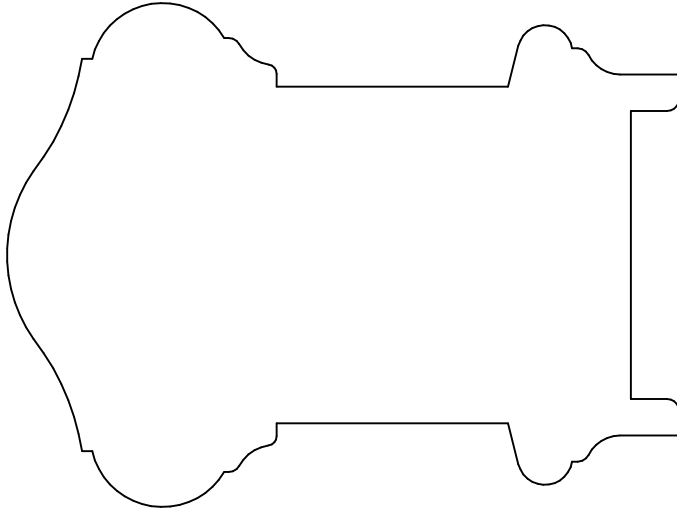

**KL 4900P**  
3.500 x 2.625

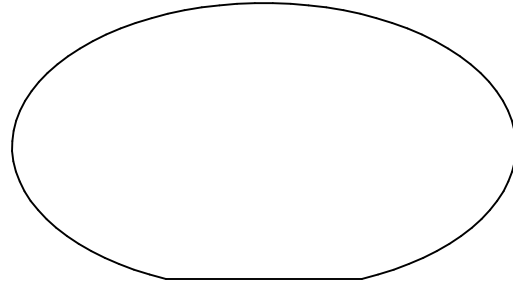

**KL 4902**  
1.437 x 2.625

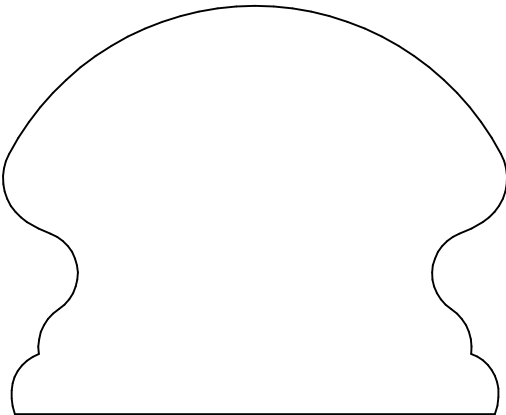

**KL 4907**  
2.125 x 2.625

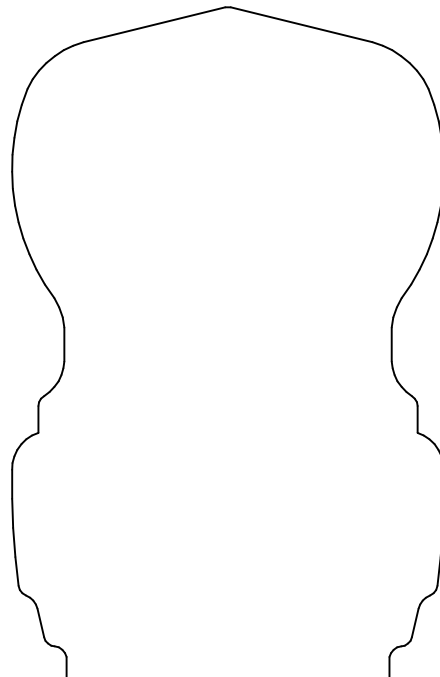

**KL 4903**  
3.500 x 2.250

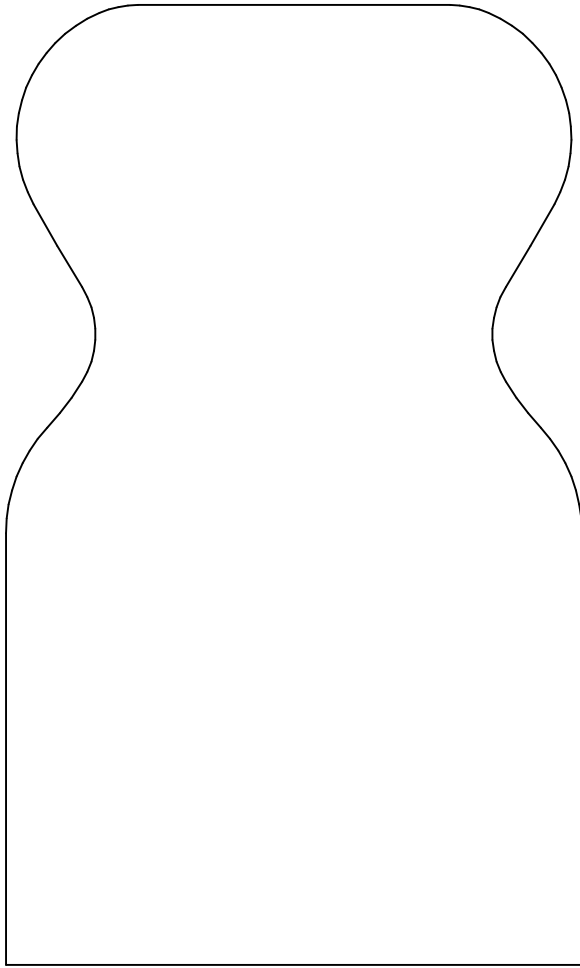

**KL 4901**  
5.000 x 3.000

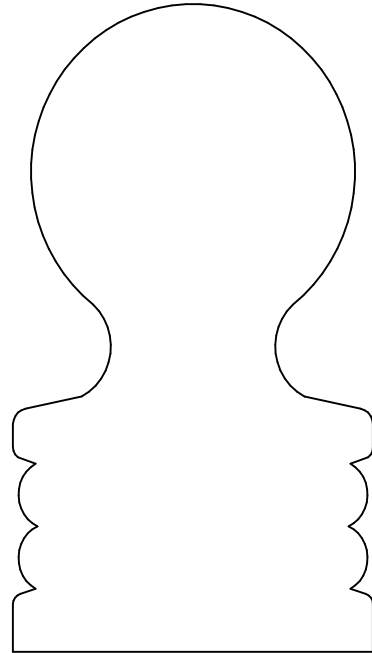

**KL 4904**  
3.375 x 1.875

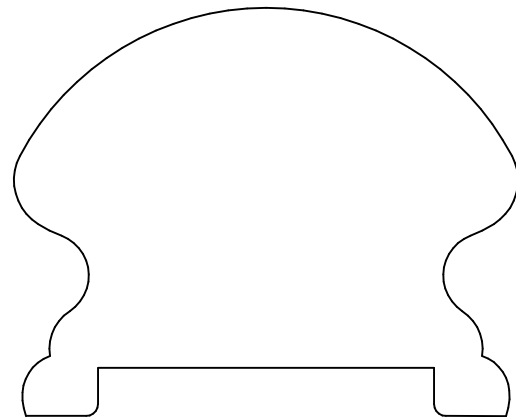

**KL 4907P**  
2.125 x 2.625

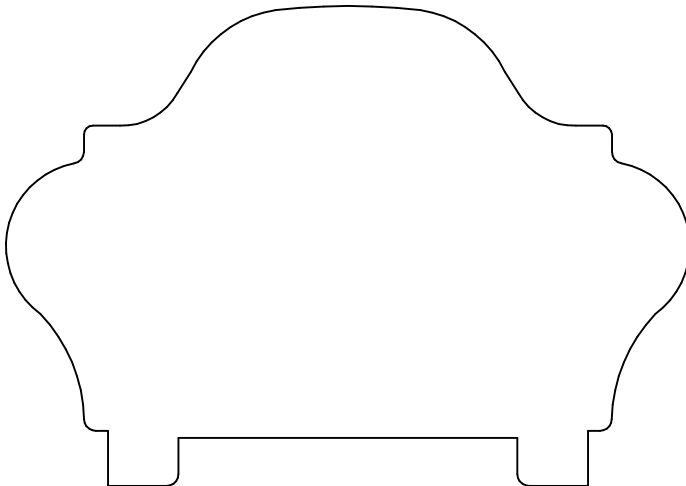

**KL 4905P**  
2.500 x 3.563

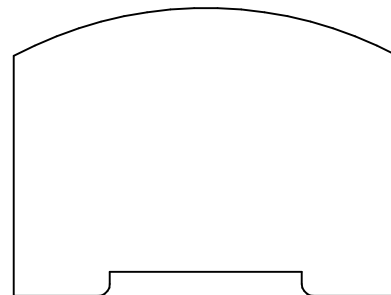

**KL 4911P**  
1.500 x 2.000

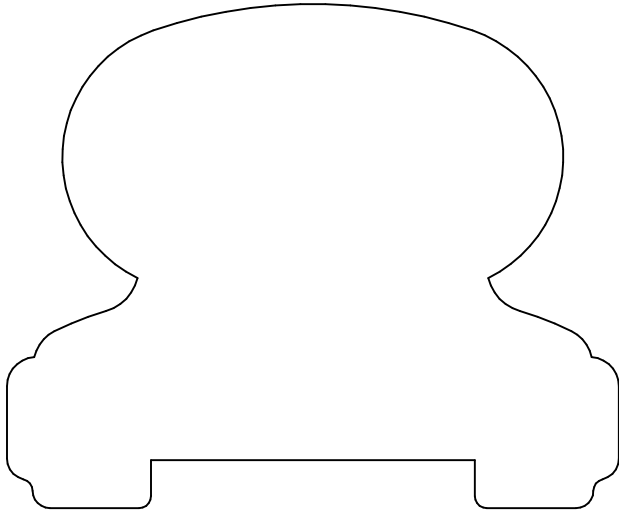

**KL 4906P**  
2.625 x 3.187

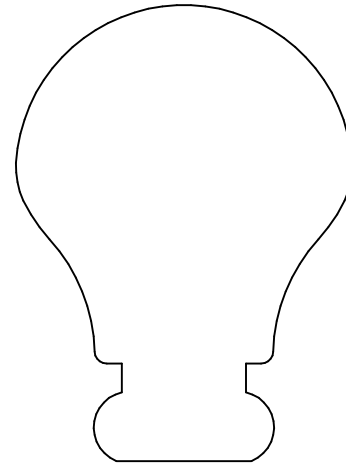

**KL 4908**  
2.375 x 1.750

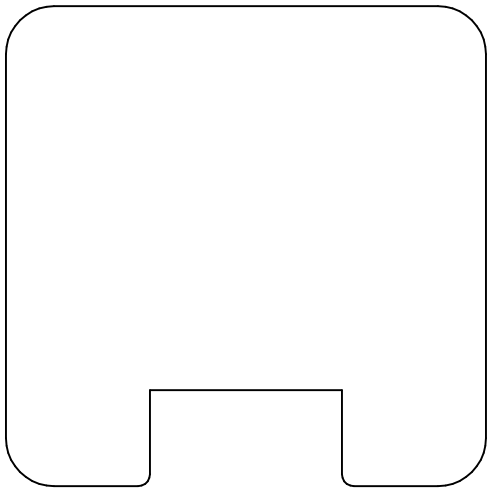

**KL 4909P**  
2.500 x 2.500

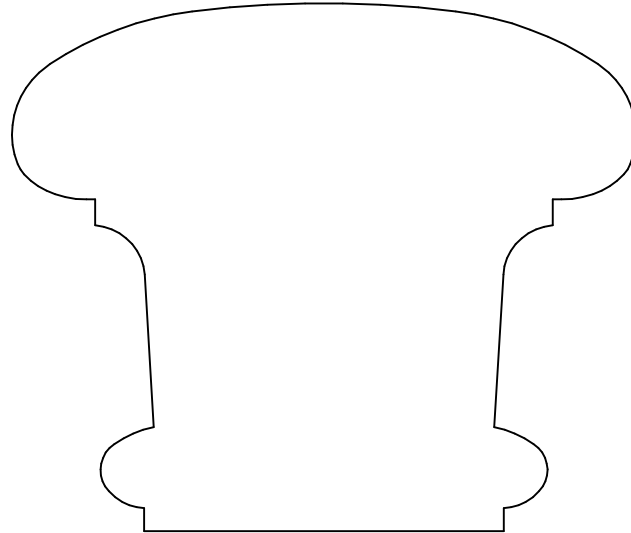

**KL 4910**  
2.750 x 3.250

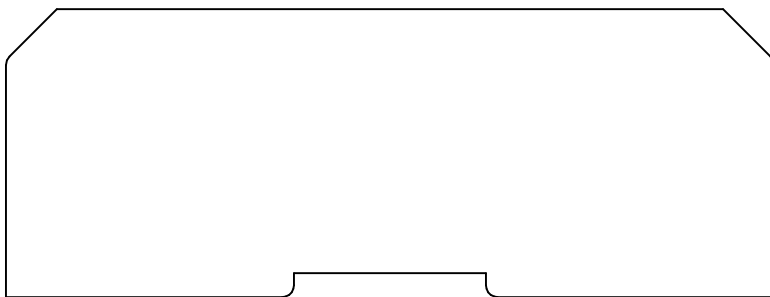

**KL 4916P**  
1.500 x 4.000

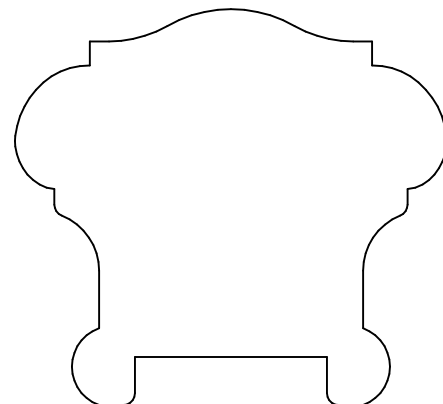

**KL 4918P**  
2.062 x 2.250

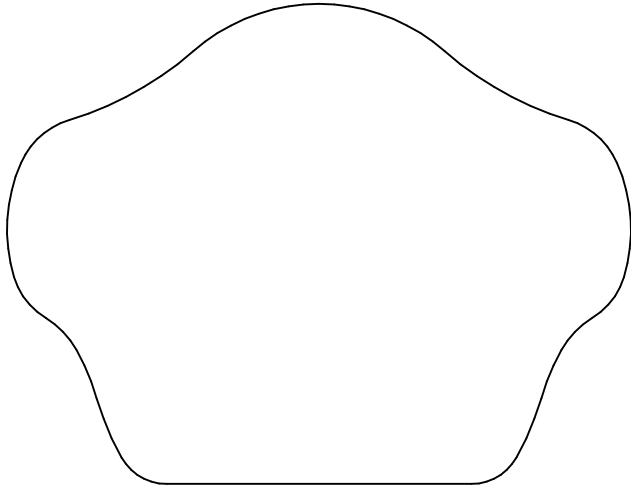

**KL 4912**  
2.500 x 3.250

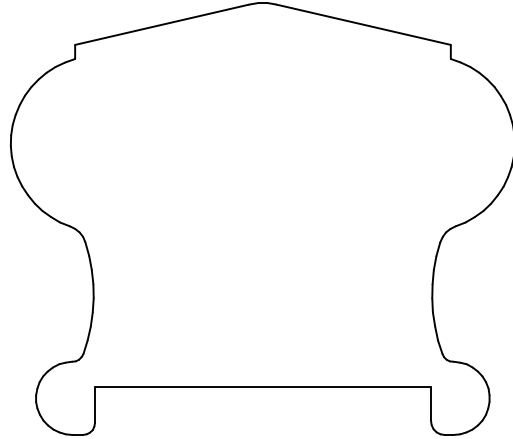

**KL 4913P**  
2.250 x 2.625

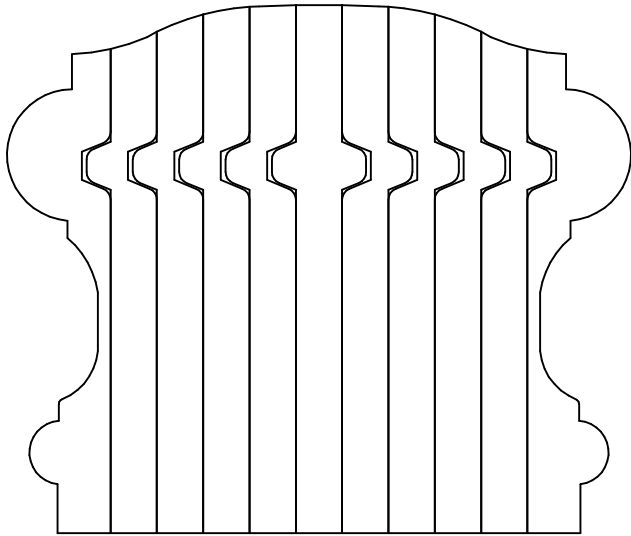

**KL 4914B**  
2.750 x 3.250

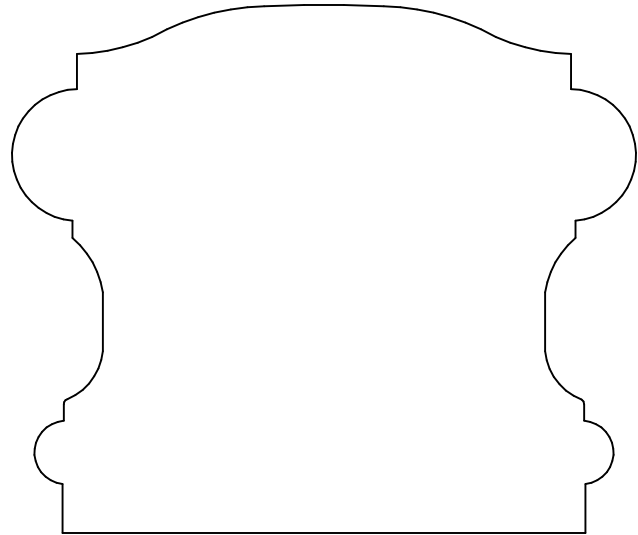

**KL 4914**  
2.750 x 3.250

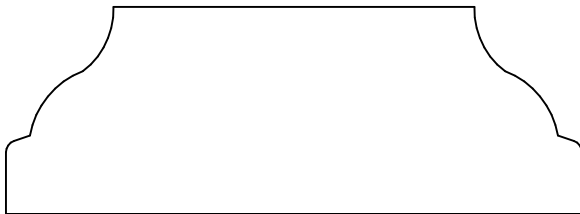

**KL 4919**  
1.078 x 3.000

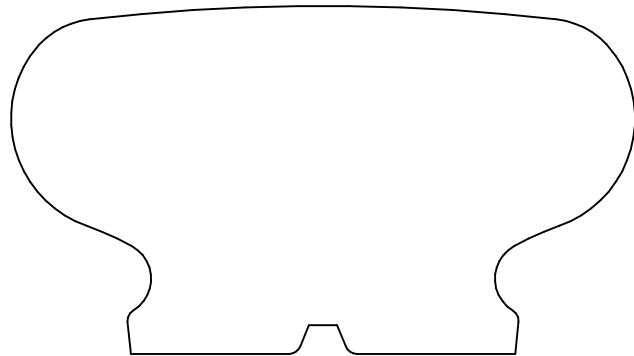

**KL 4920**  
1.812 x 3.250

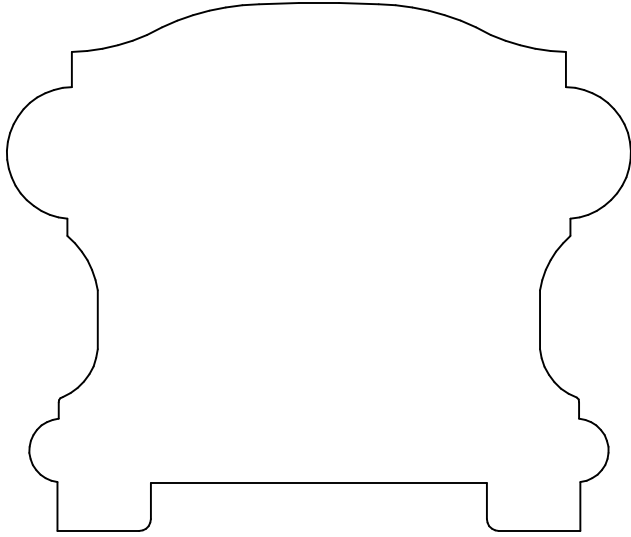

**KL 4914 P**  
2.750 x 3.250

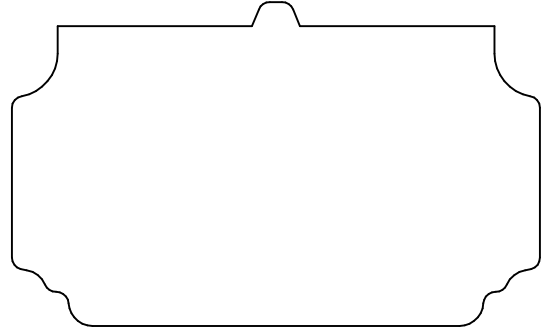

**KL 4921**  
1.562 x 2.750

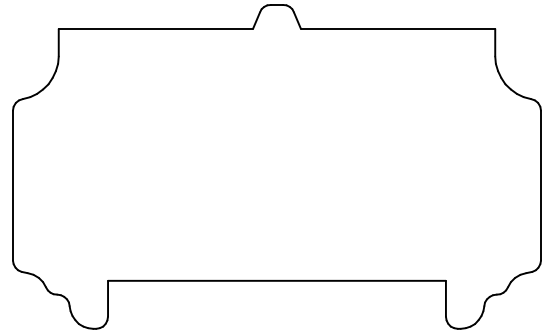

**KL 4921P**  
1.687 x 2.750

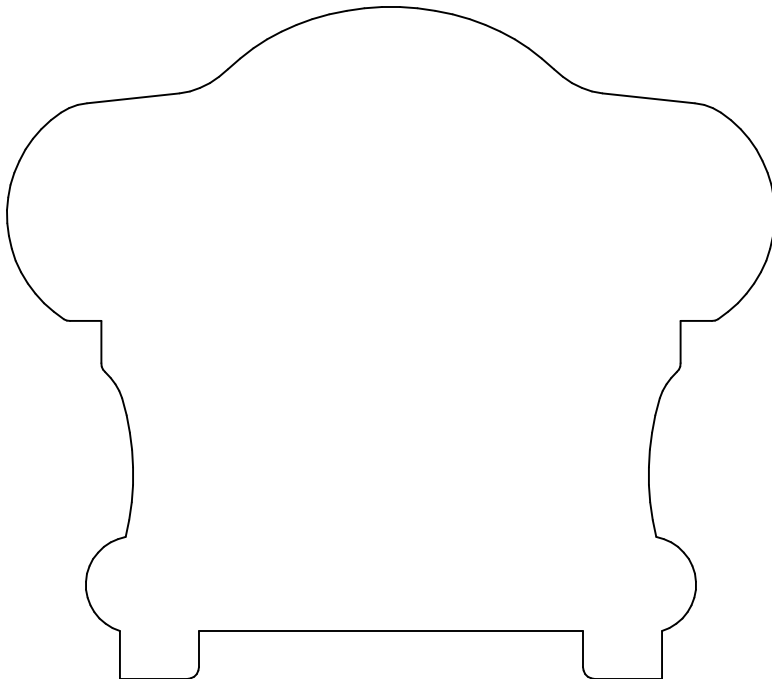

**KL 4915P**  
3.500 x 4.000



**KL 4922P**  
1.375 x 2.750

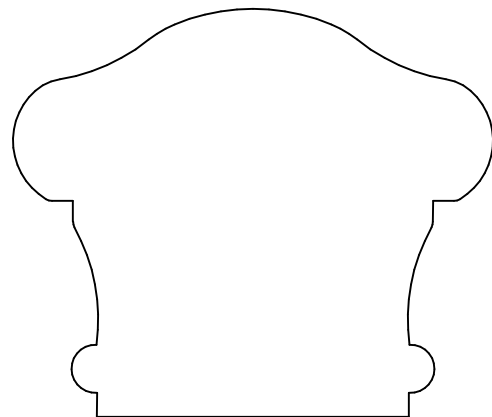

**KL 4923**  
2.125 x 2.500

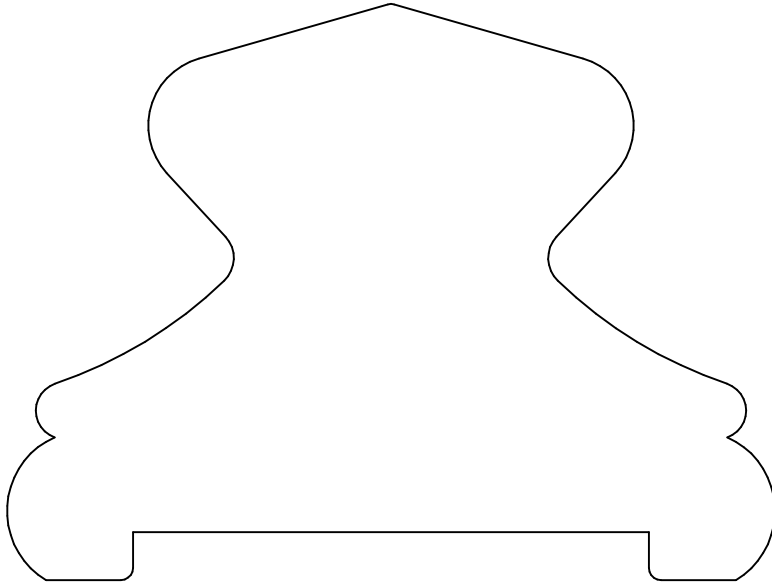

**KL 4917P**  
3.000 x 4.000

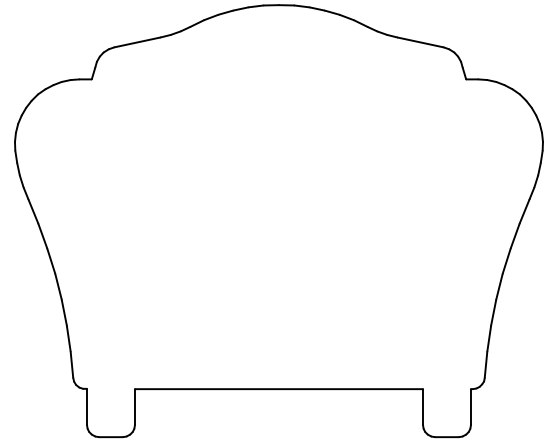

**KL 4924P**  
2.250 x 2.750

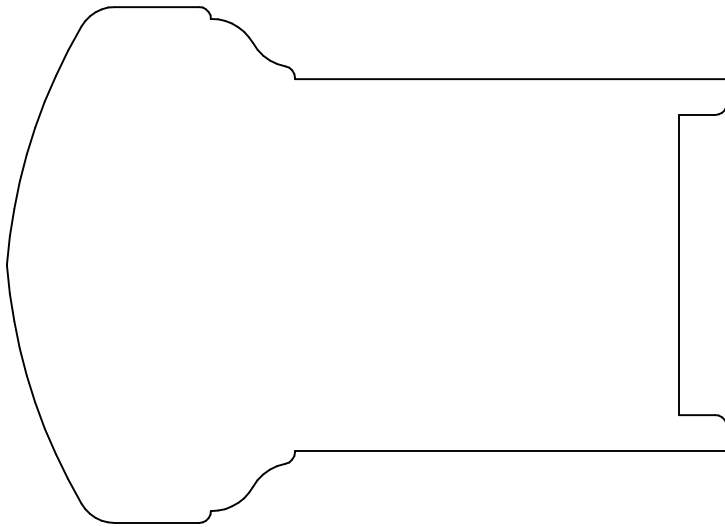

**KL 4925P**  
3.750 x 2.688

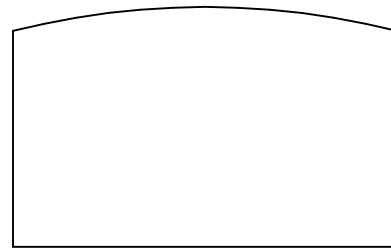

**KL 4933**  
1.250 x 2.000

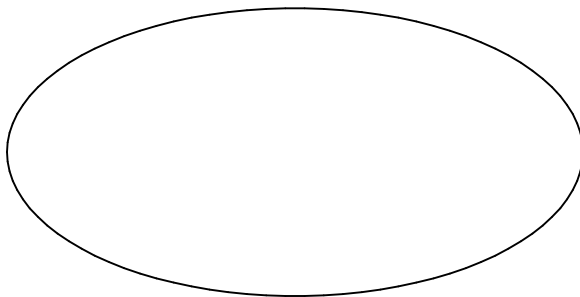

**KL 4937**  
1.500 x 3.000

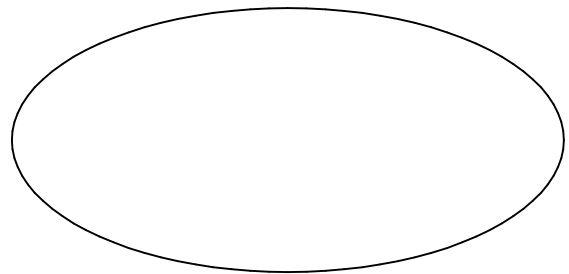

**KL 4936**  
1.375 x 2.875

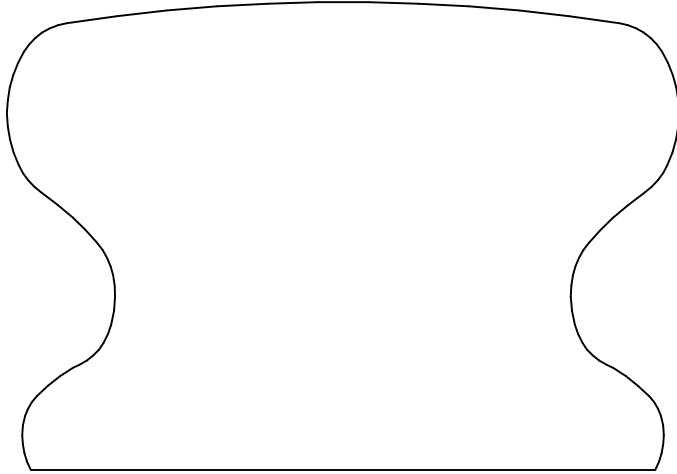

**KL 4926**  
2.438 x 3.500

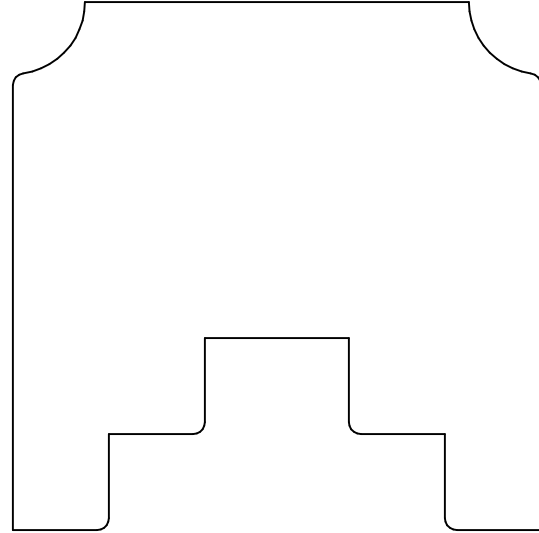

**KL 4927P**  
2.750 x 2.750

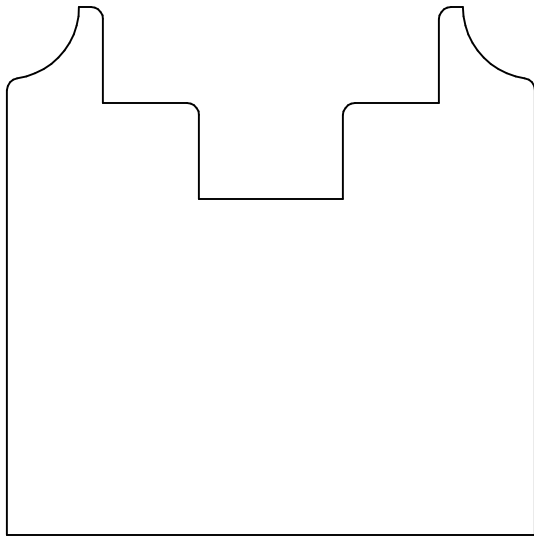

**KL 4928P**  
2.750 x 2.750

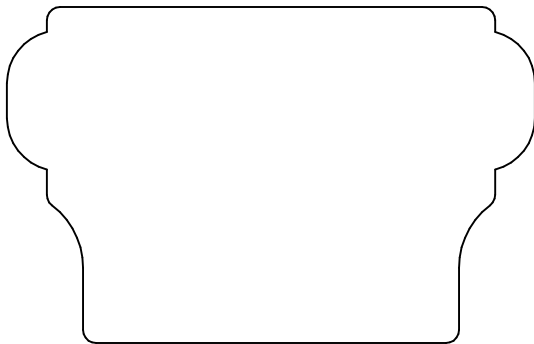

**KL 4935**  
1.750 x 2.750

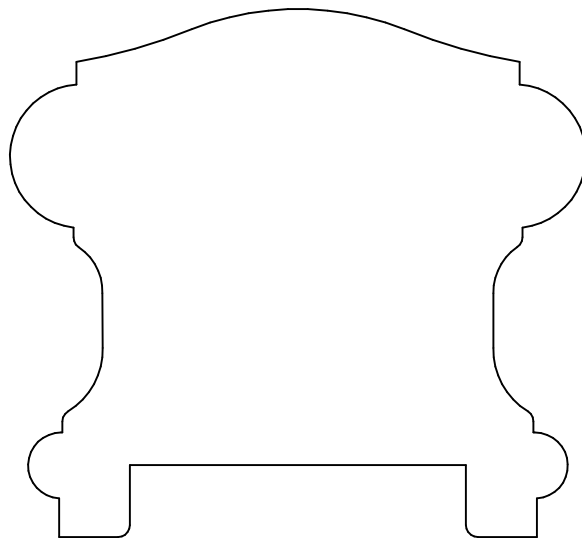

**KL 4930P**  
2.750 x 3.000



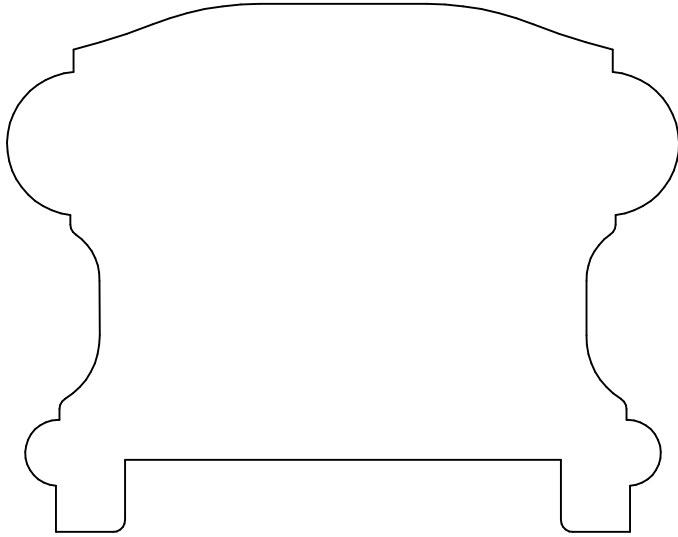

**KL 4931P**  
2.750 x 3.500

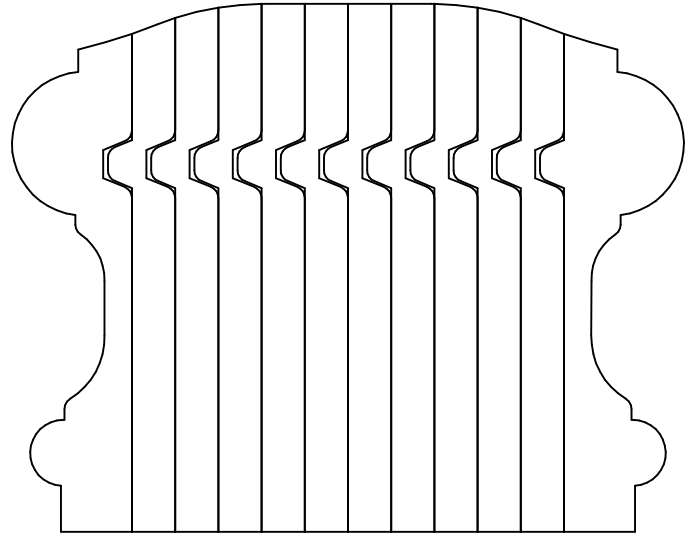

**KL4931B**  
2.750 x 3.500

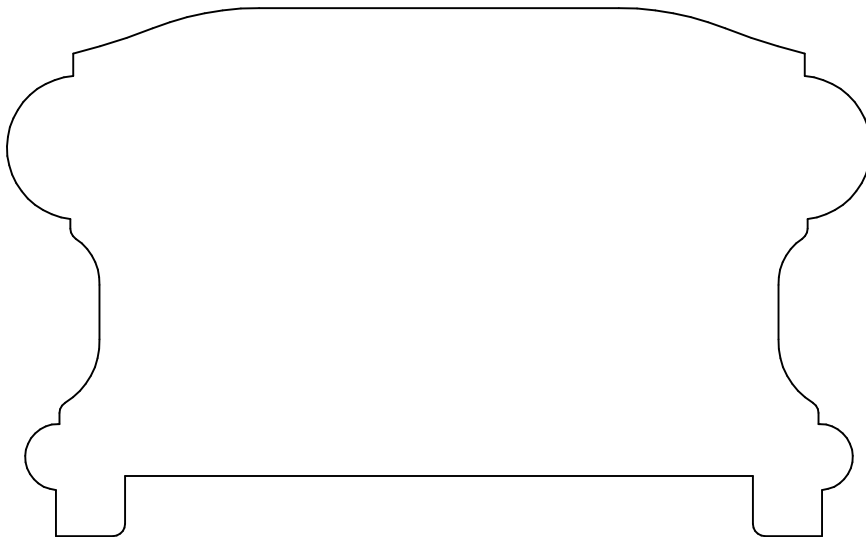

**KL 4932P**  
2.750 x 4.500

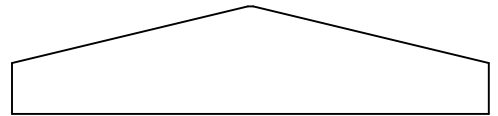

**KL 4942**  
.562 x 2.484

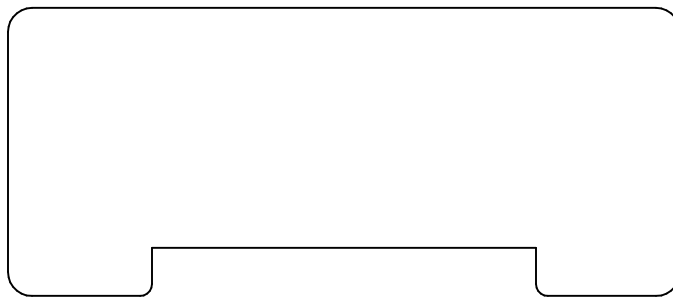

**KL 4938P**  
1.500 x 3.500

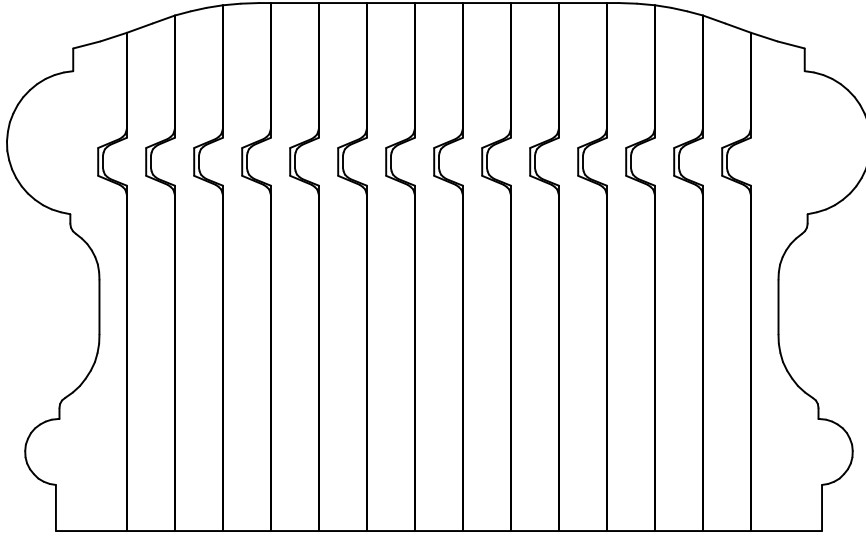

**KL 4932B**  
2.750 x 4.500

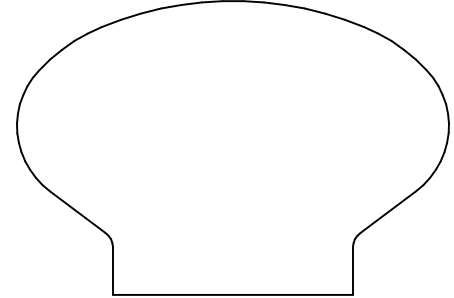

**KL 4954**  
1.531 x 2.250

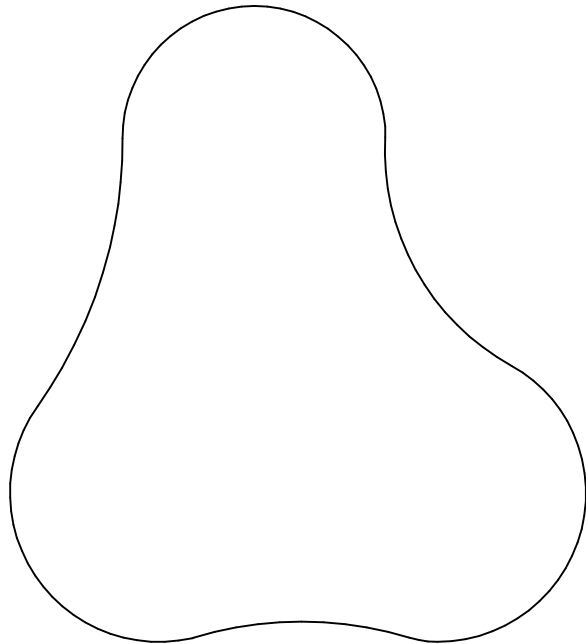

**KL 4939**  
3.312 x 3.000

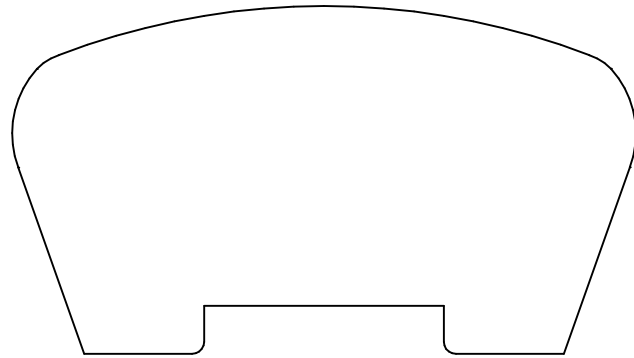

**KL 4940P**  
1.812 x 3.250

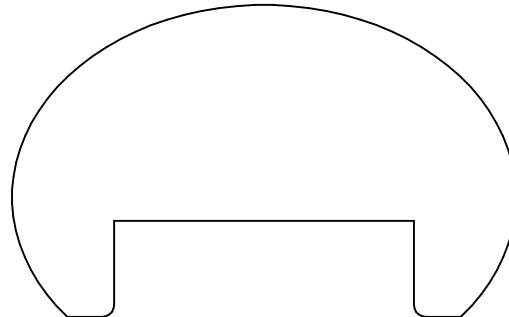

**KL 4943P**  
1.625 x 2.625

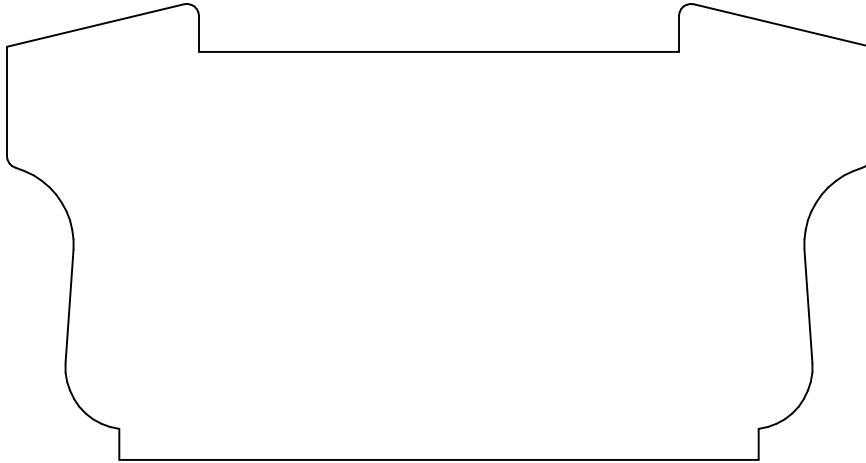

**KL 4941P**  
2.375 x 4.500

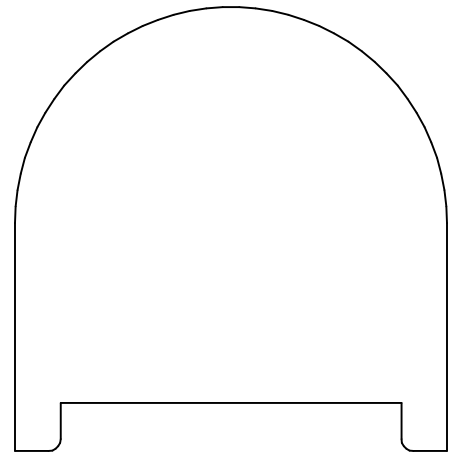

**KL 4960P**  
2.312 x 2.250

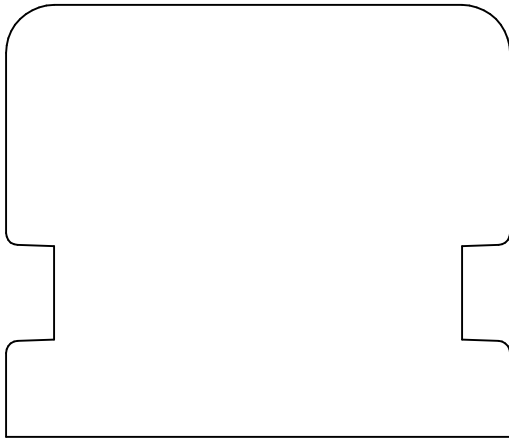

**KL 4944**  
2.250 x 2.625

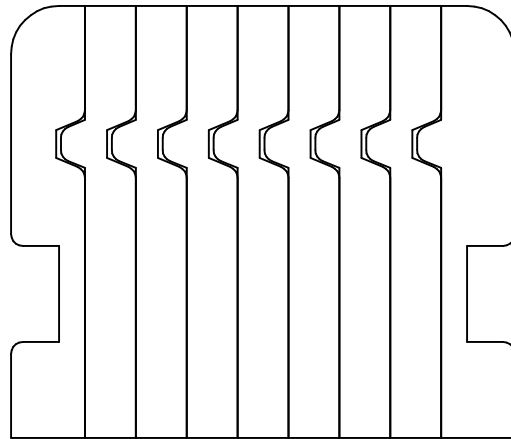

**KL 4944B**  
2.250 x 2.625

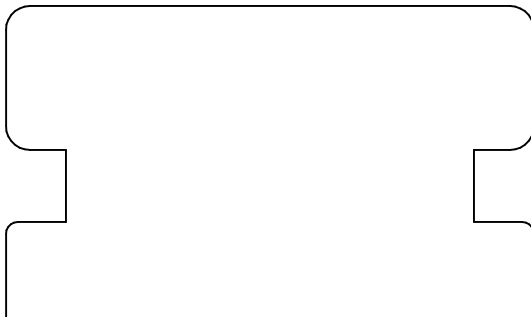

**KL 4951**  
1.625 x 2.750

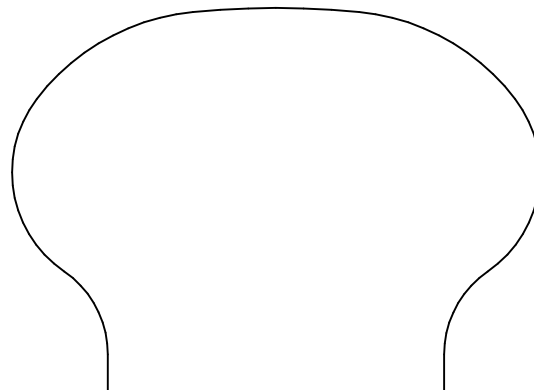

**KL 4952**  
2.000 x 2.750

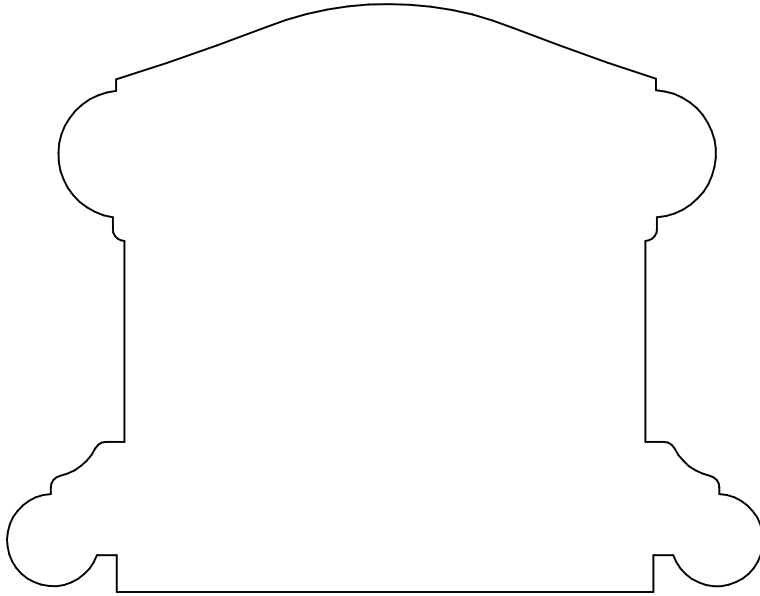

**KL 4945**  
3.062 x 3.938

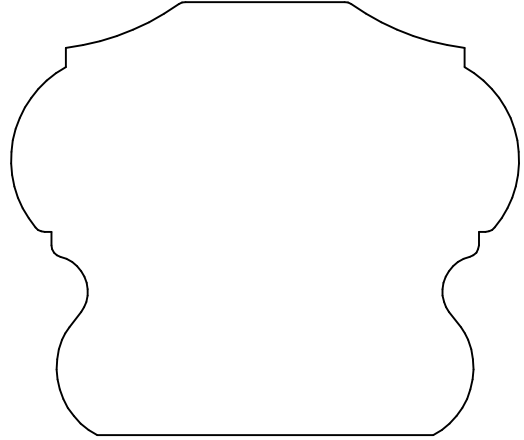

**KL 4947**  
2.256 x 2.646

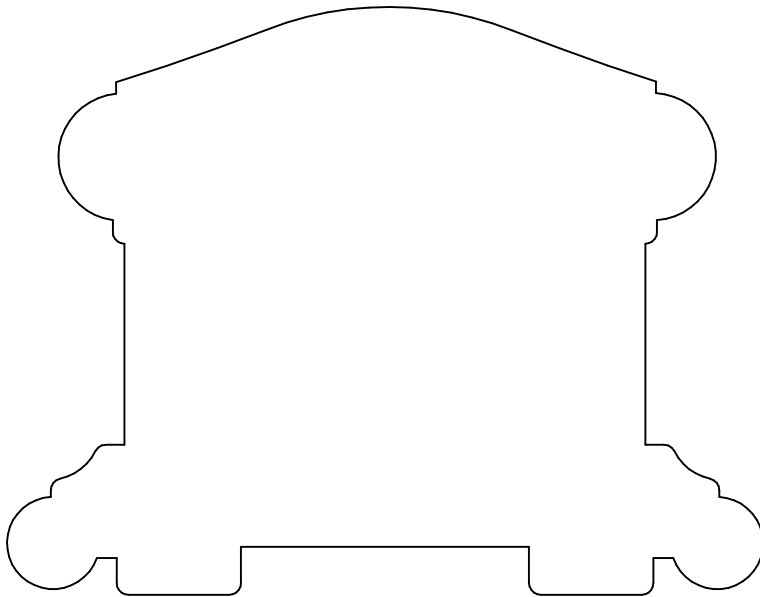

**KL 4945P**  
3.062 x 3.938

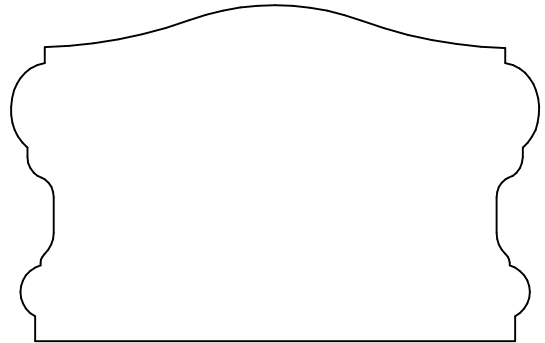

**KL 4955**  
1.750 x 2.750

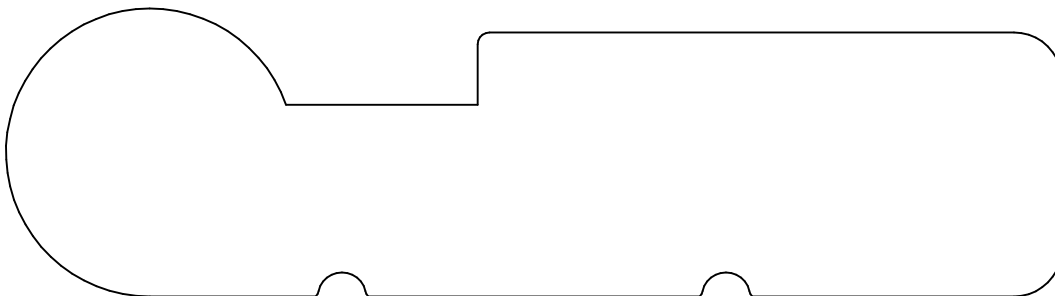

**KL 4964**  
1.500 x 5.500

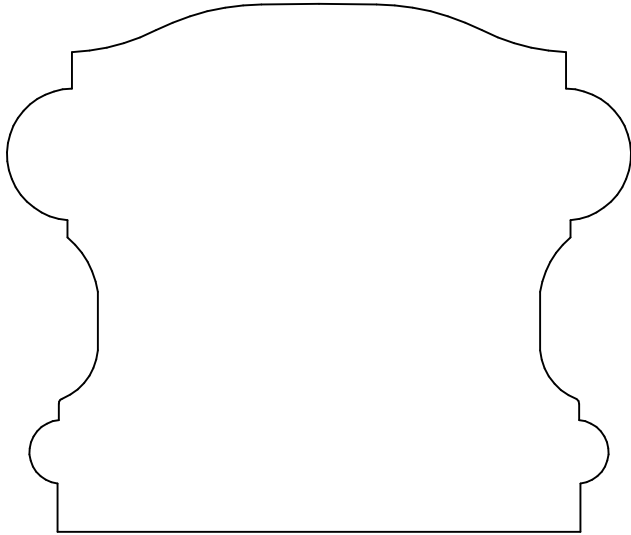

**KL 4946**  
2.750 x 3.250

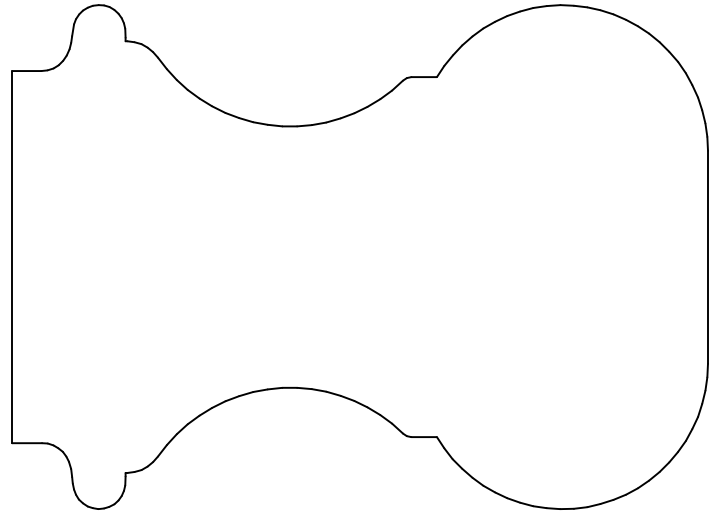

**KL 4950**  
3.625 x 2.625

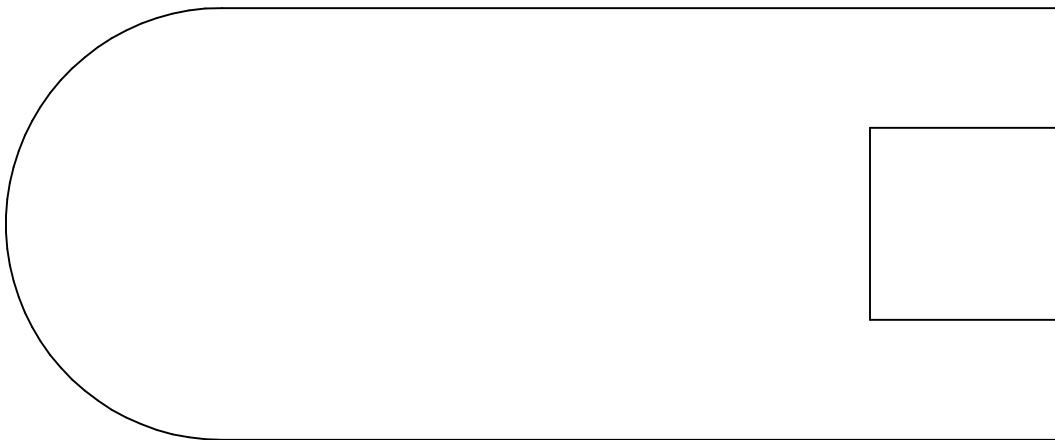

**KL 4948P**  
2.250 x 5.500

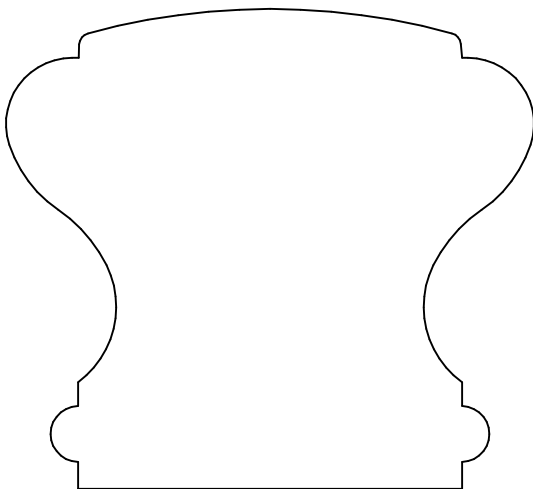

**KL 4956**  
2.500 x 2.750

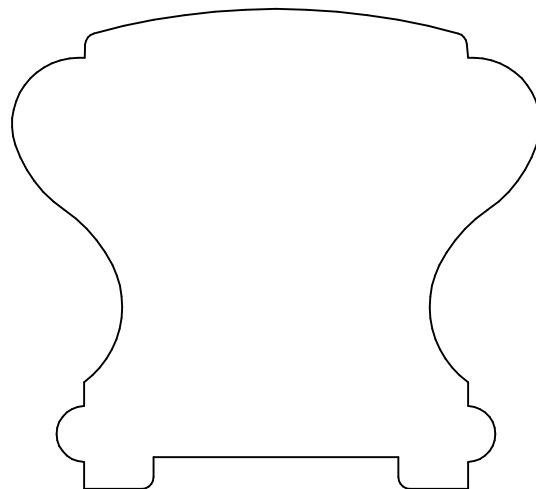

**KL 4956P**  
2.500 x 2.750

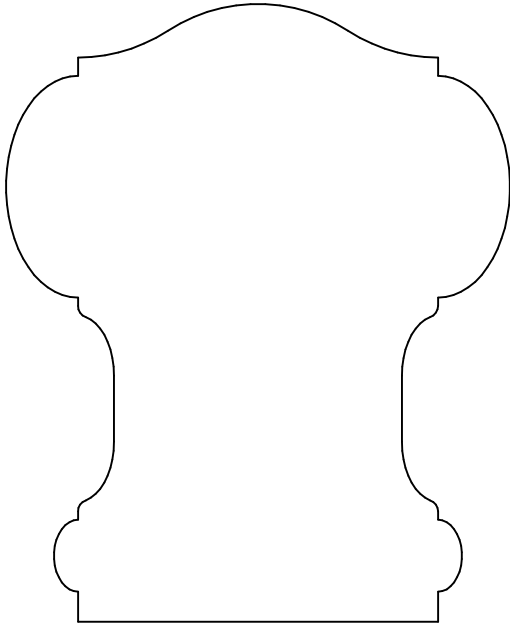

**KL 4953**  
3.218 x 2.625

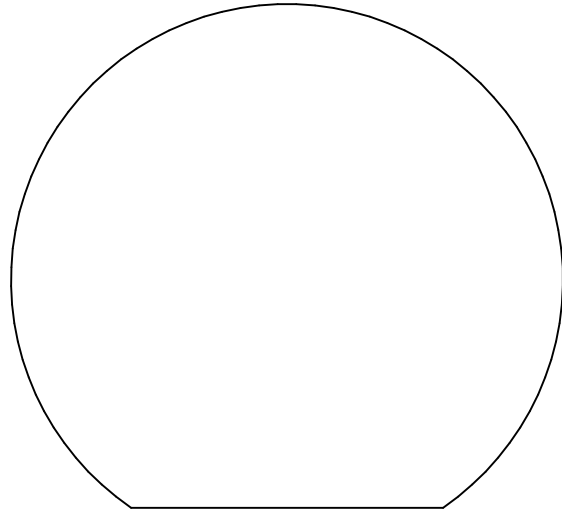

**KL 4957**  
2.623 x 2.875

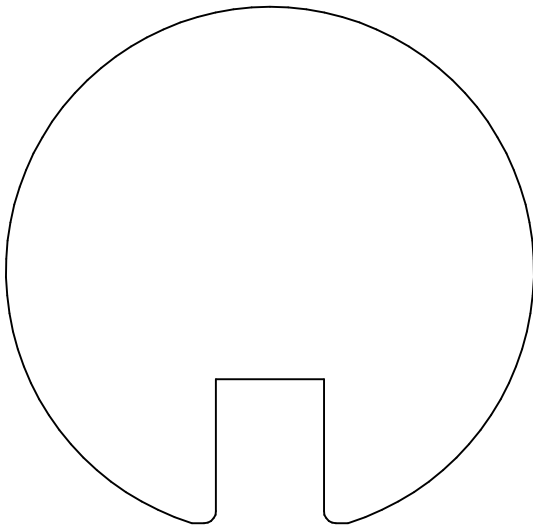

**KL 4958P**  
2.689 x 2.750

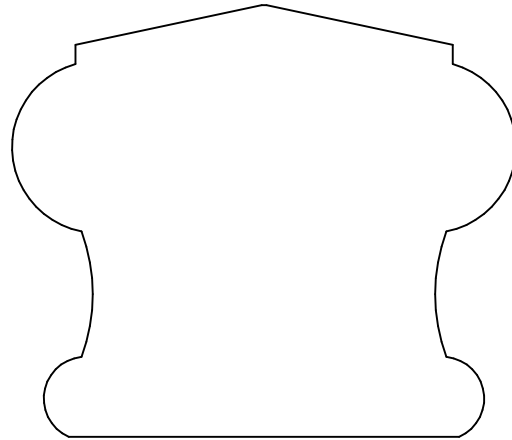

**KL 4959**  
2.250 x 2.625

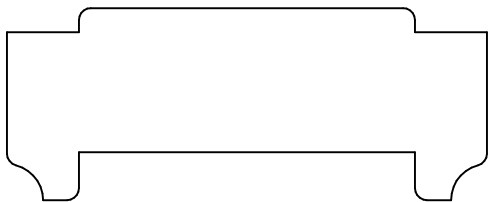

**KL 4976P**  
1.000 x 2.500

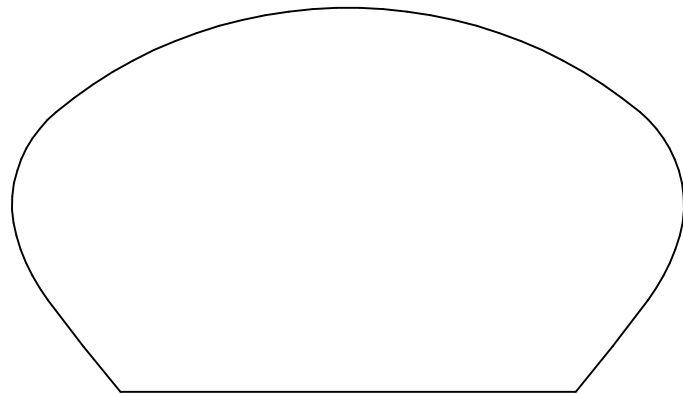

**KL 4961**  
2.000 x 3.500

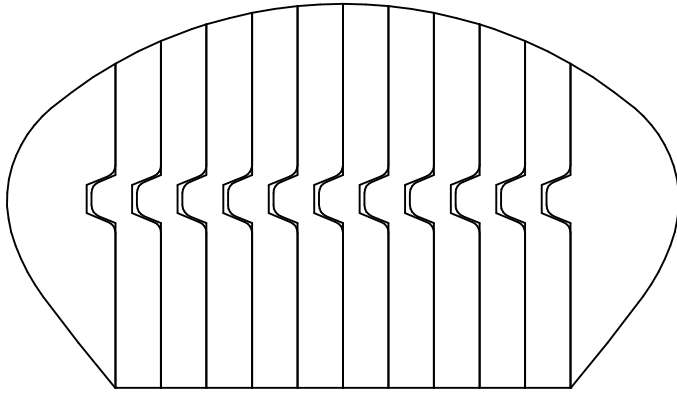

**KL 4961B**  
2.000 x 3.500

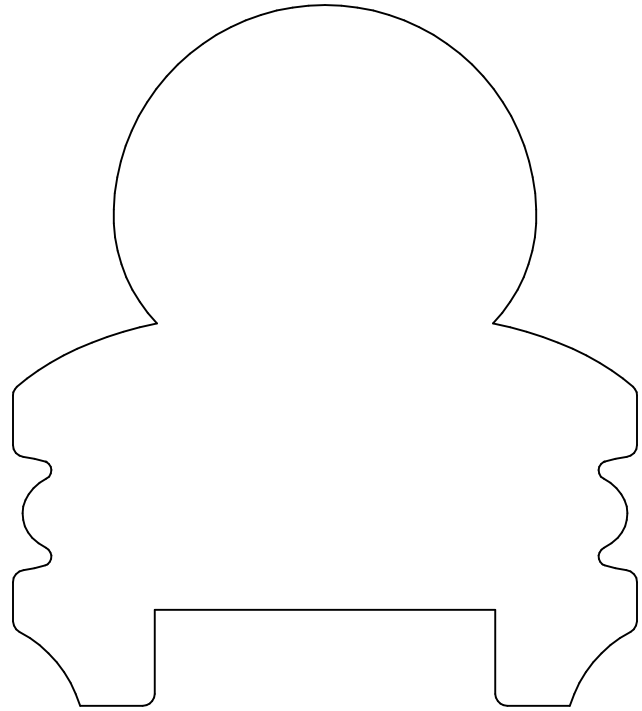

**KL 4962P**  
3.650 x 3.250

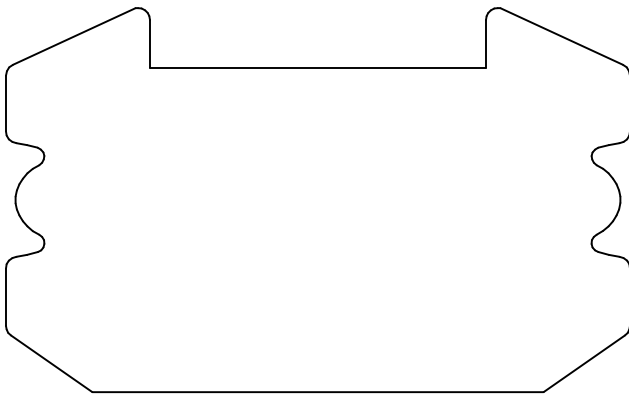

**KL 4963P**  
2.000 x 3.250



**KL 4977**  
.250 x 1.750

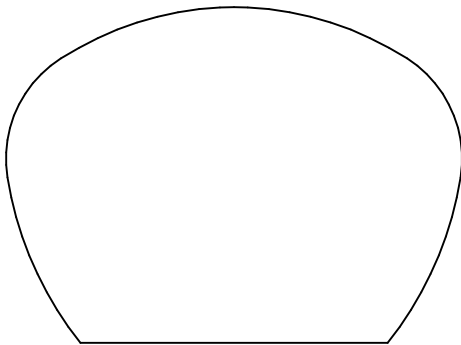

**KL 4965**  
1.750 x 2.375



**KL 4979P**  
1.125 x 2.000

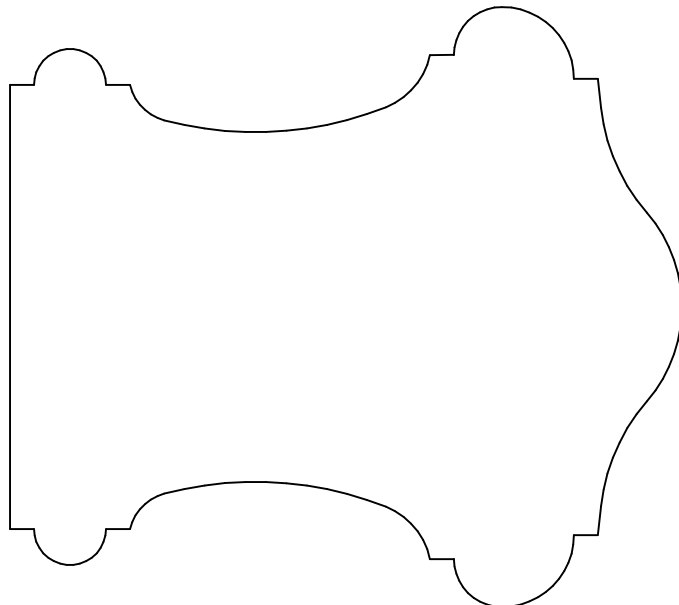

**KL 4967**  
3.500 x 3.125

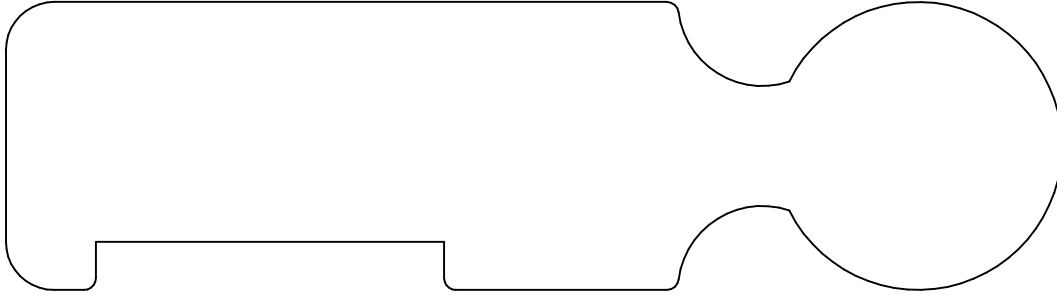

**KL 4966**  
1.500 x 5.500

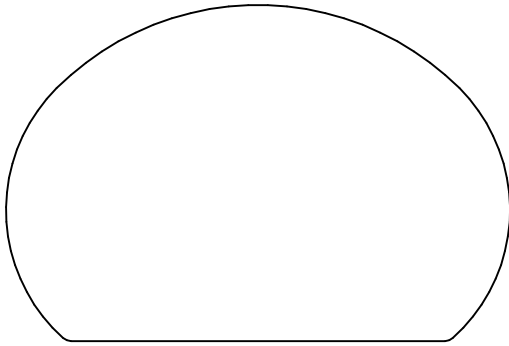

**KL 4968**  
1.750 x 2.625

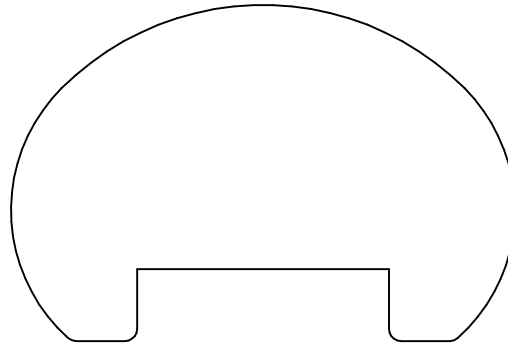

**KL 4968P**  
1.750 x 2.625

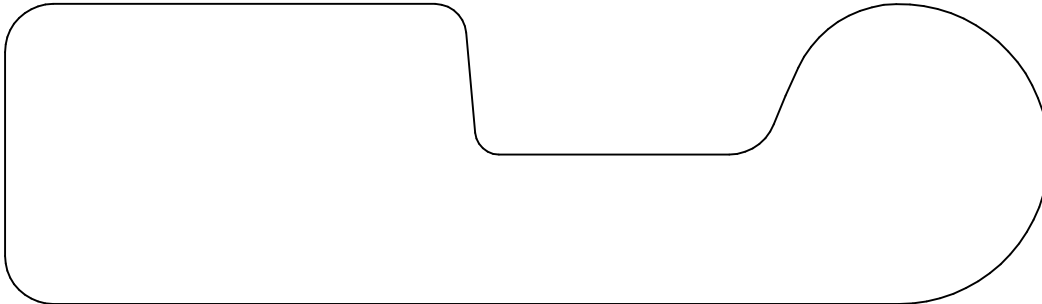

**KL 4969**  
1.562 x 5.437

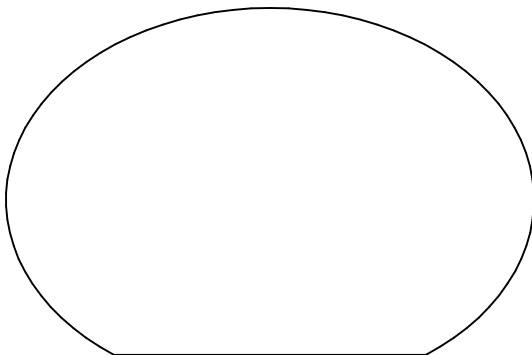

**KL 4970**  
1.807 x 2.750

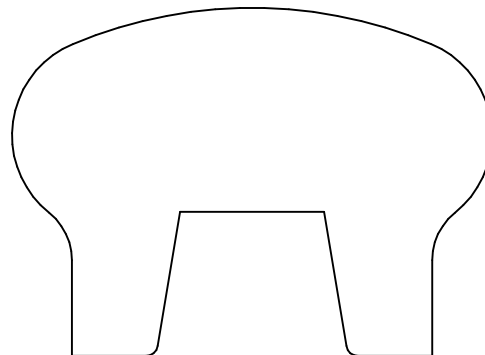

**KL 4971P**  
1.813 x 2.500



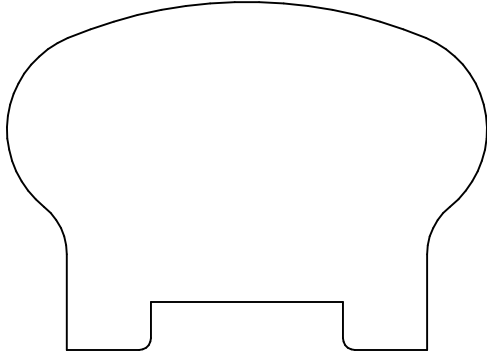

**KL 4972P**  
1.813 x 2.500

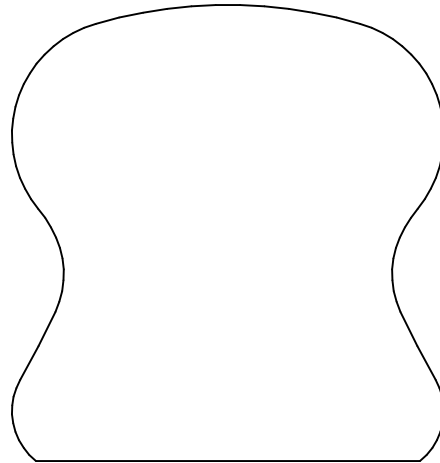

**KL 4973**  
2.375 x 2.250

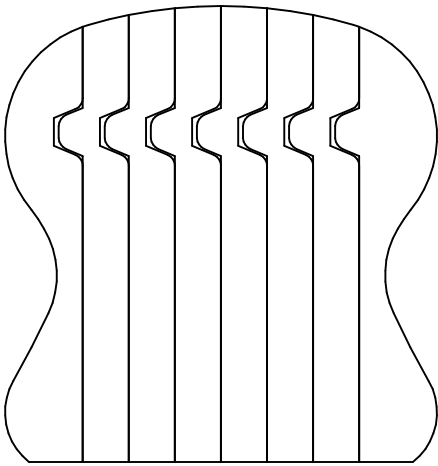

**KL 4973B**  
2.375 x 2.250

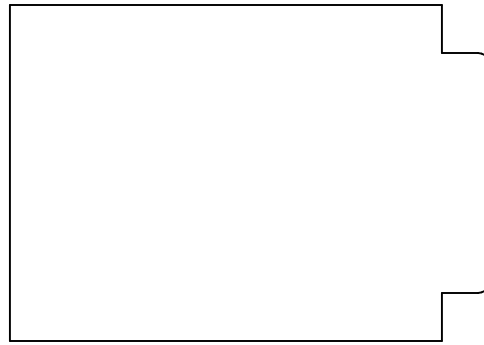

**KL 4974**  
1.750 x 2.500

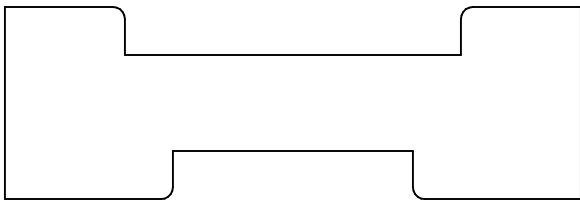

**KL 4975P**  
1.000 x 3.000

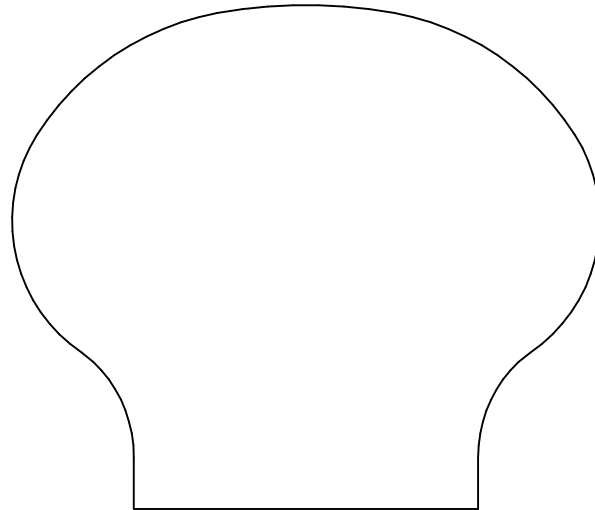

**KL 4978**  
2.625 x 3.062

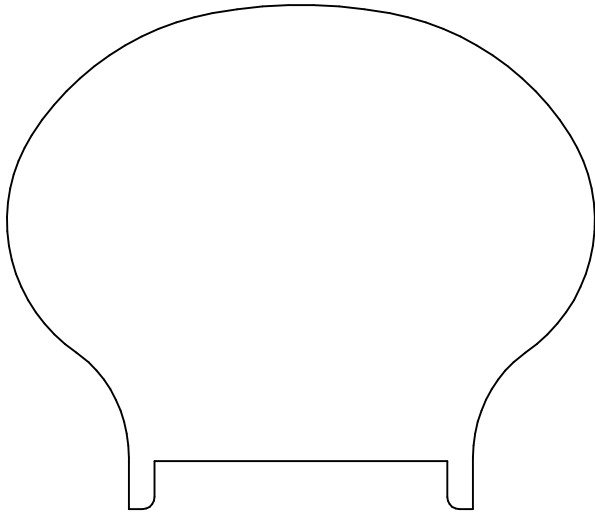

**KL 4978P**  
2.625 x 3.062

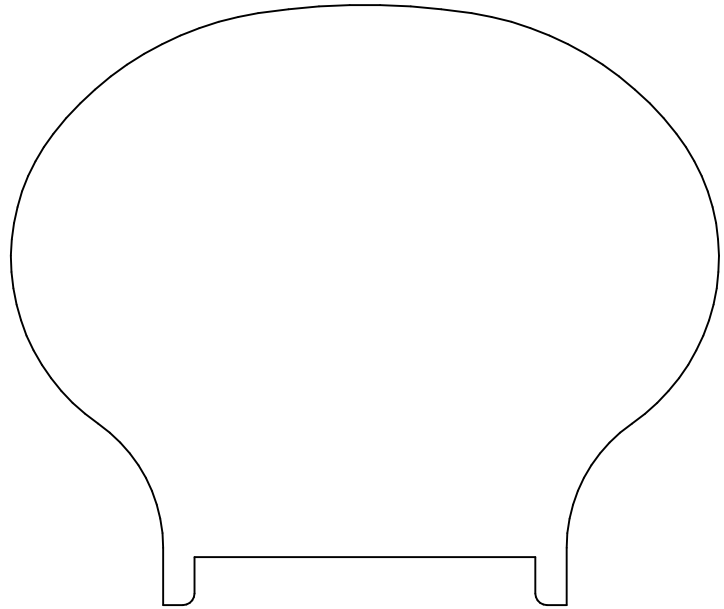

**KL 4980P**  
3.125 x 3.688

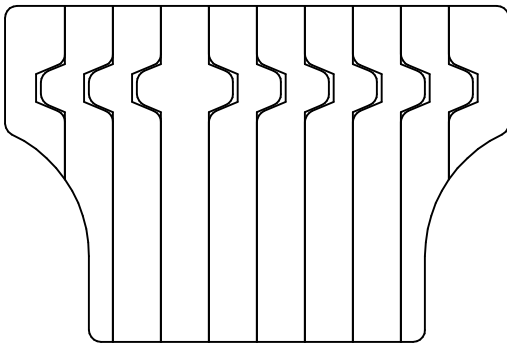

**KL 4981B**  
1.750 x 2.625

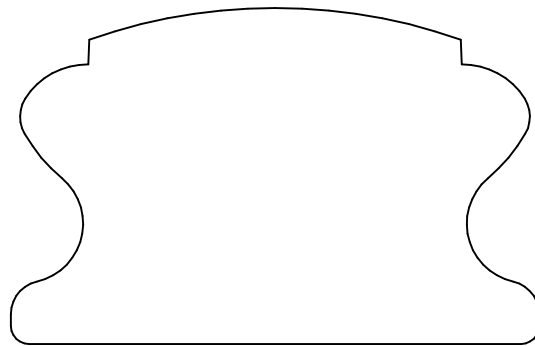

**KL 4983**  
1.750 x 2.750

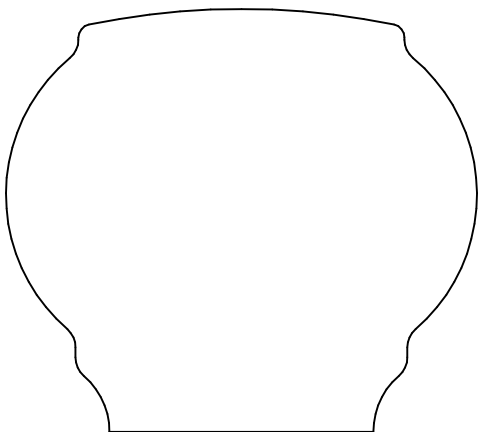

**KL 4984**  
2.203 x 2.453

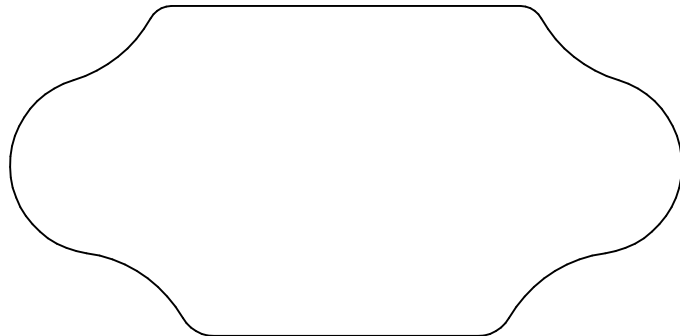

**KL 4985**  
1.719 x 3.500

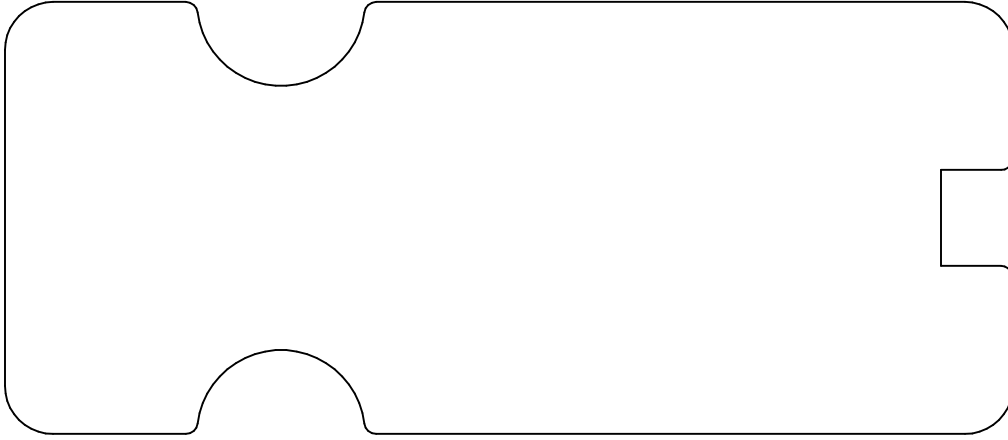

**KL 4986P**  
2.250 x 5.250

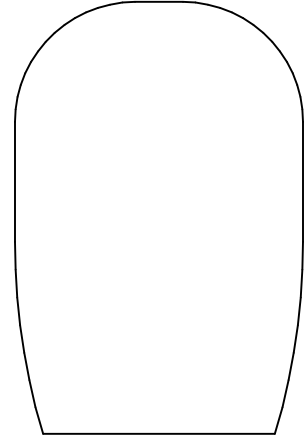

**KL4996**  
2.250 x 1.500

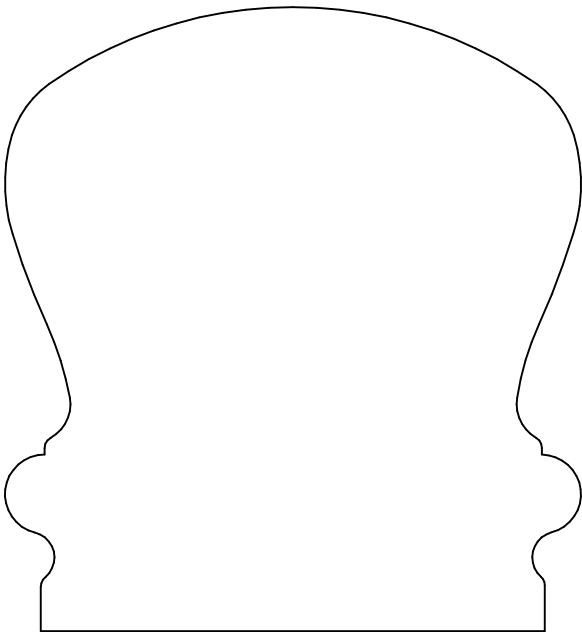

**KL 4987**  
3.250 x 3.000

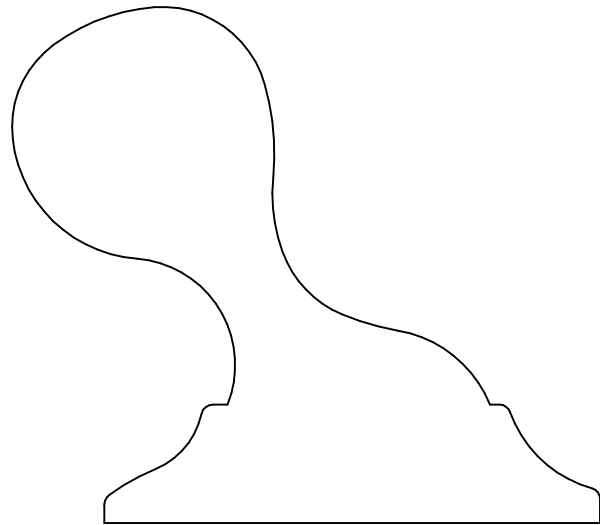

**KL 4988**  
2.687 x 3.062

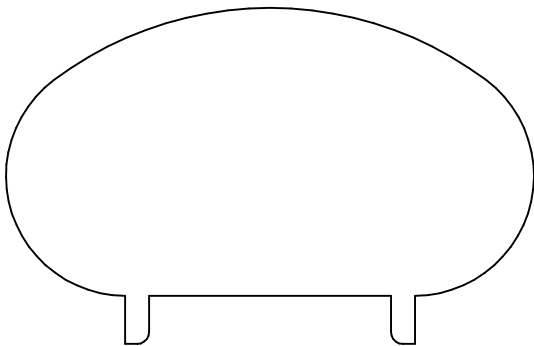

**KL 4992P**  
1.750 x 2.750

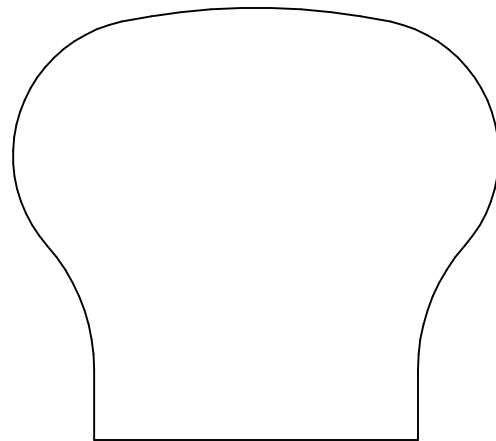

**KL 4990**  
2.250 x 2.531

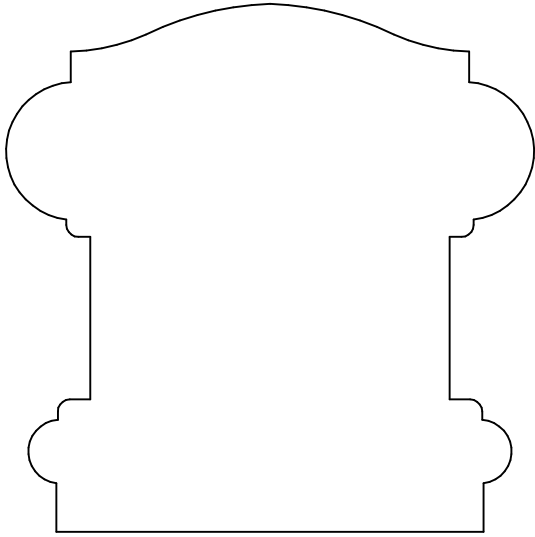

**KL 4989**  
2.750 x 2.750

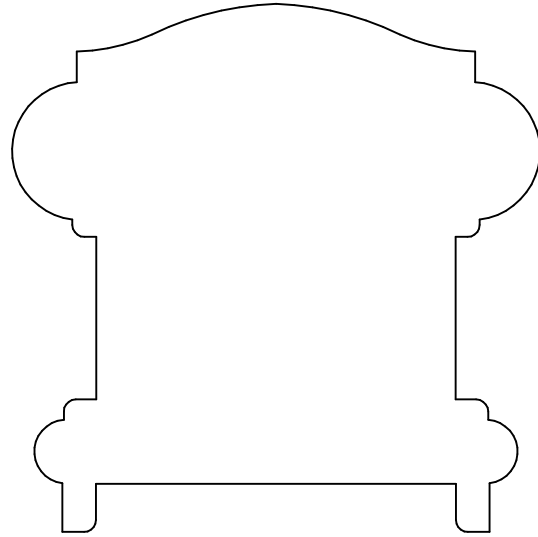

**KL 4989P**  
2.750 x 2.750

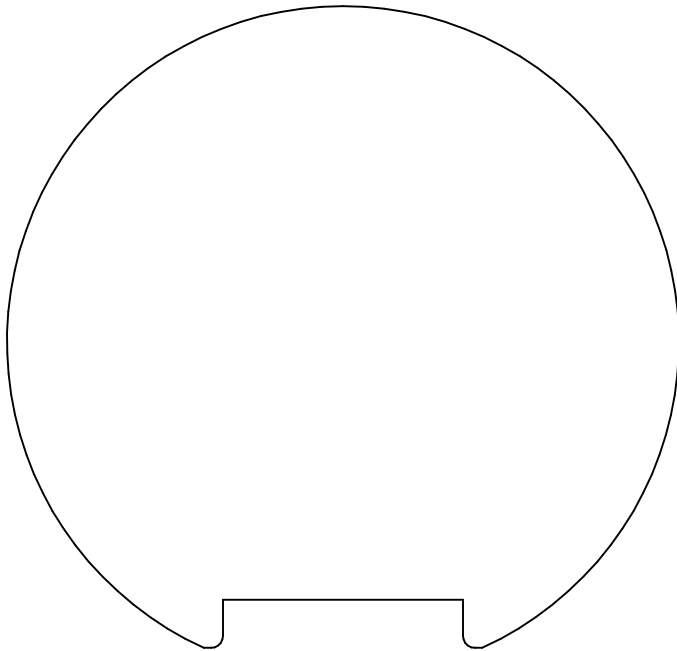

**KL 4991P**  
3.343 x 3.500

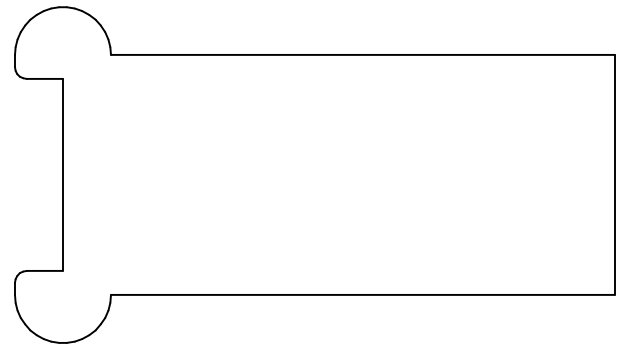

**KL 4993P**  
1.750 x 3.125



**KL 4998**  
1.281 x 2.500

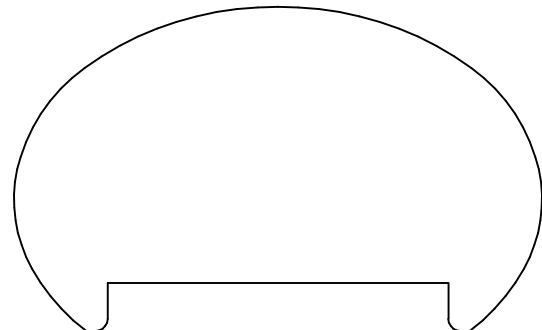

**KL 4994P**  
1.687 x 2.750

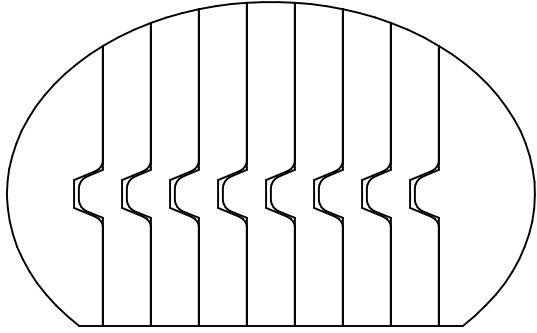

**KL 4994B**  
1.683 x 2.750

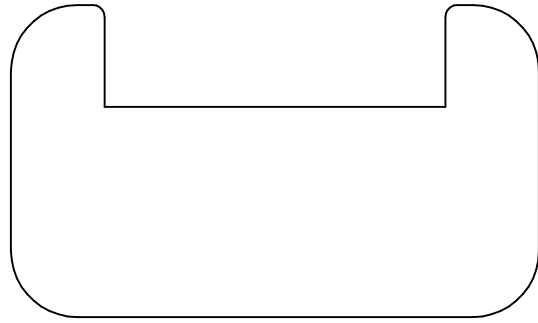

**KL 5906P**  
1.625 x 2.750

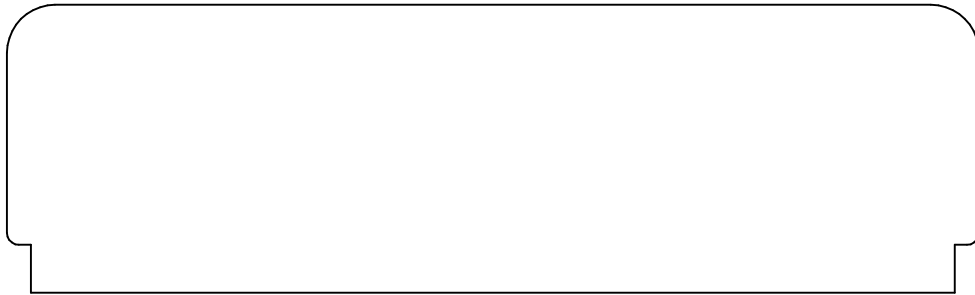

**KL 4995**  
1.500 x 5.062

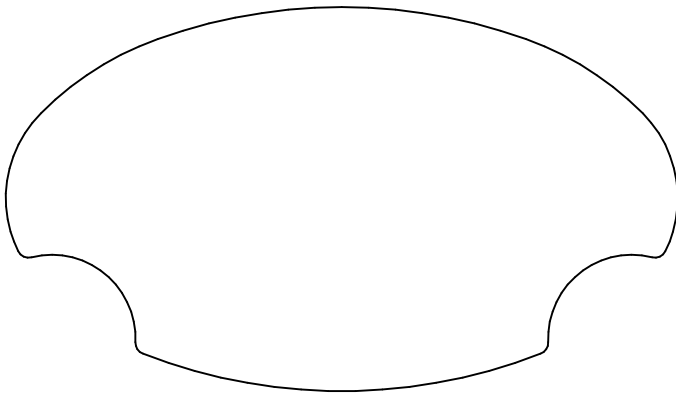

**KL 4997**  
2.000 x 3.500

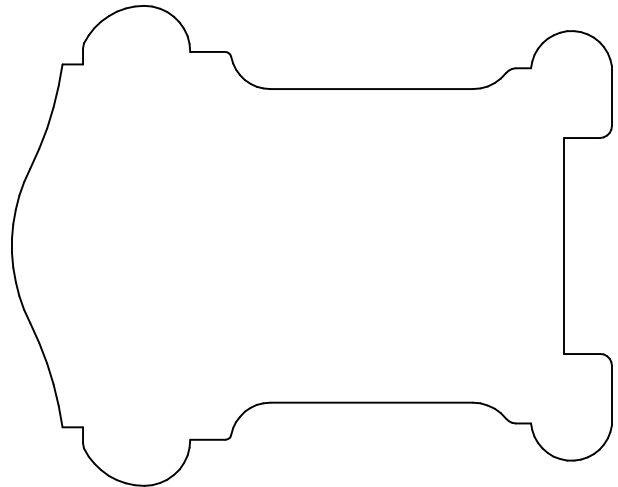

**KL 4999P**  
3.125 x 2.500

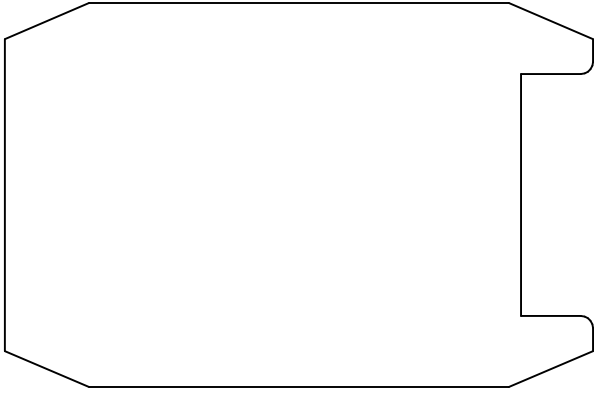

**KL 5900P**  
2.000 x 3.062

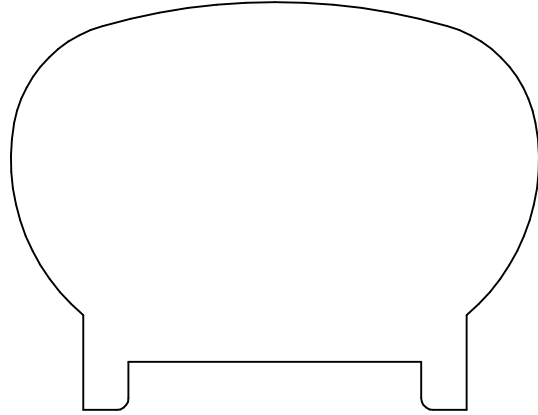

**KL 5901P**  
2.125 x 2.750

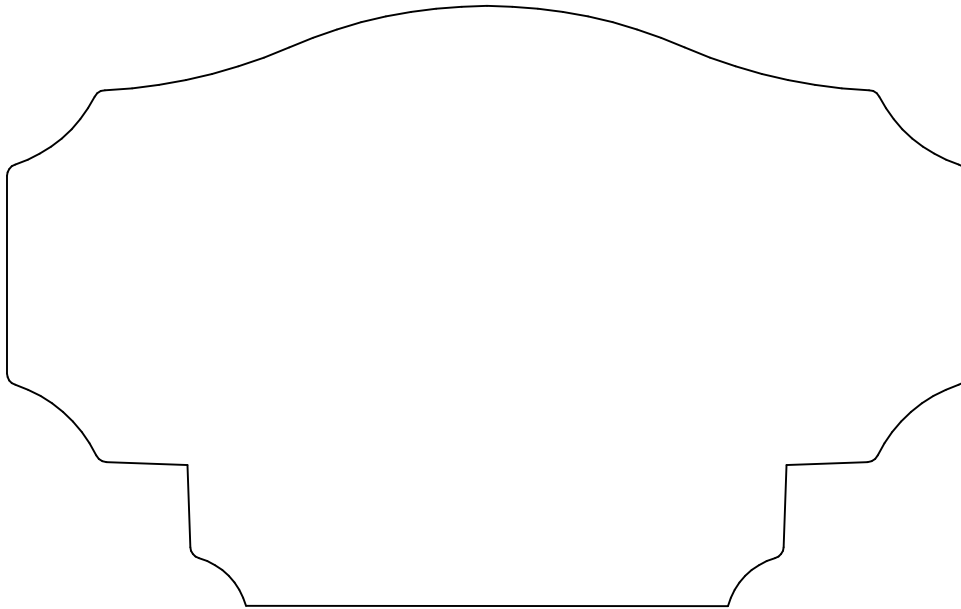

**KL 5902**  
3.125 x 5.000

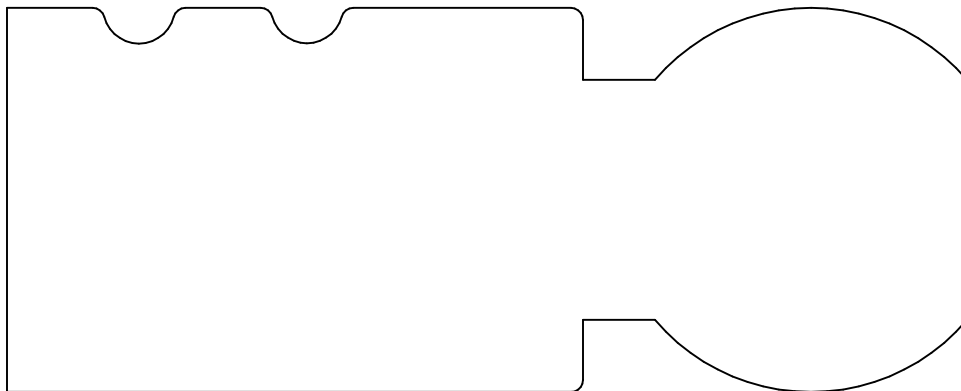

**KL 5905**  
2.000 x 5.000

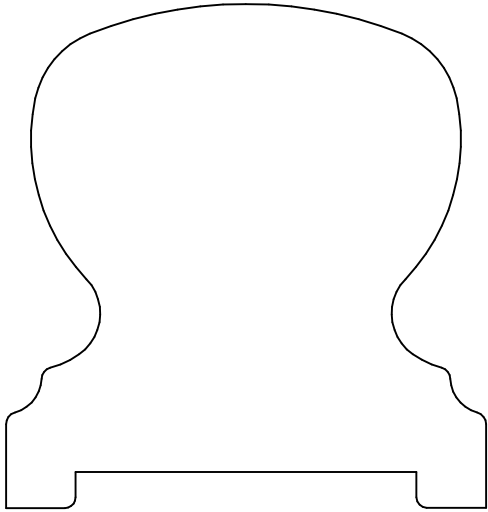

**KL 5903P**  
2.625 x 2.500

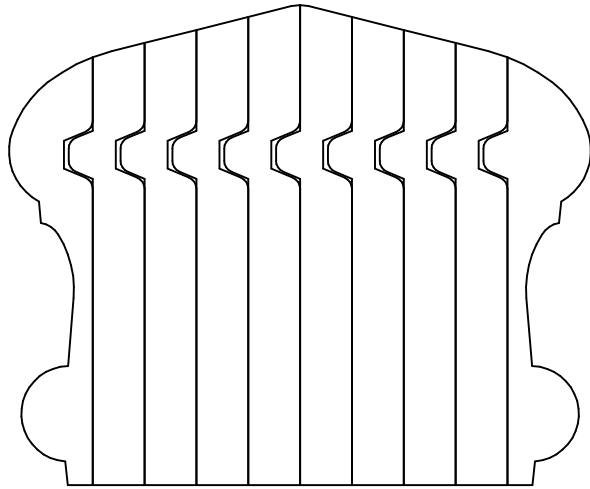

**KL 5904B**  
2.500 x 3.031

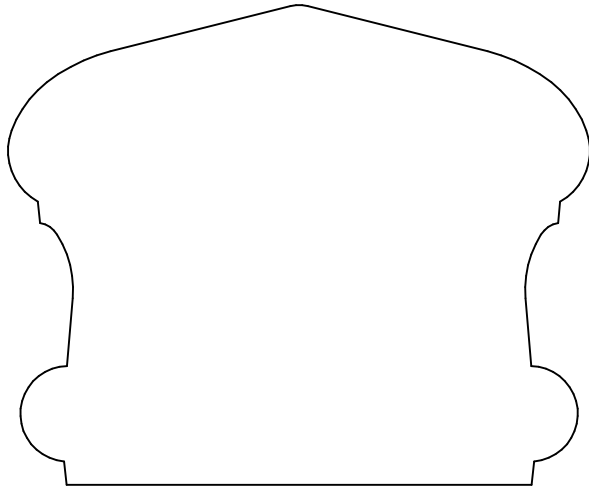

**KL 5904**  
2.500 x 3.031

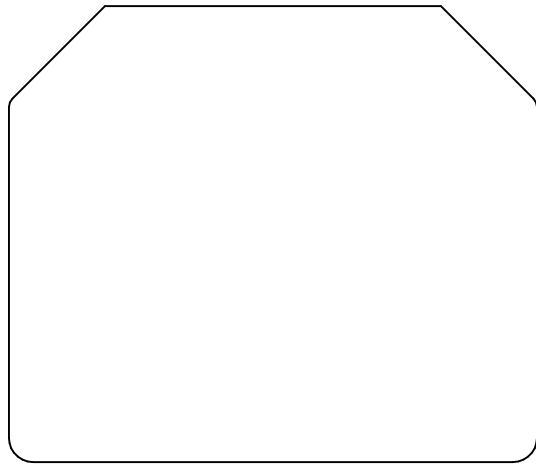

**KL 5907**  
2.375 x 2.750

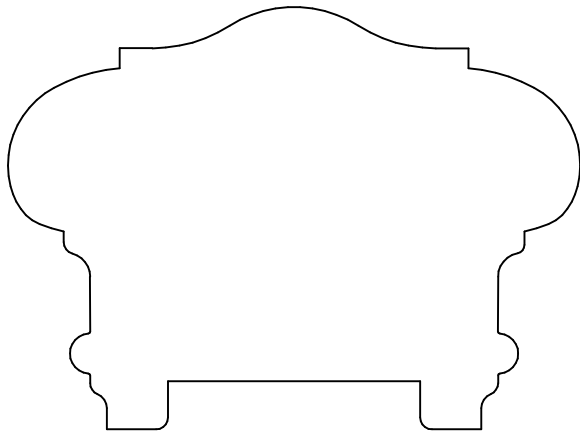

**KL 5908P**  
2.200 x 2.980

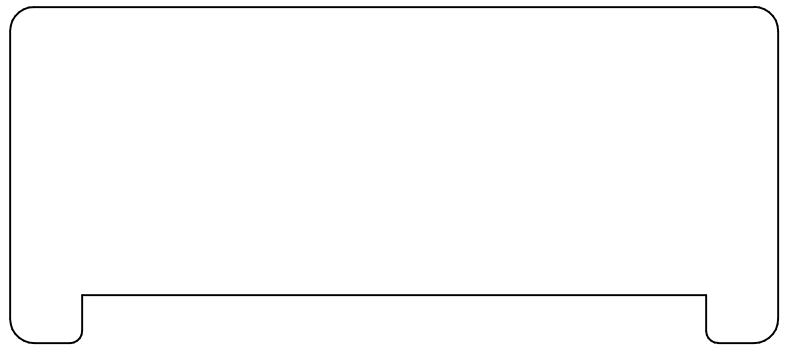

**KL5909P**  
1.750 x 4.000

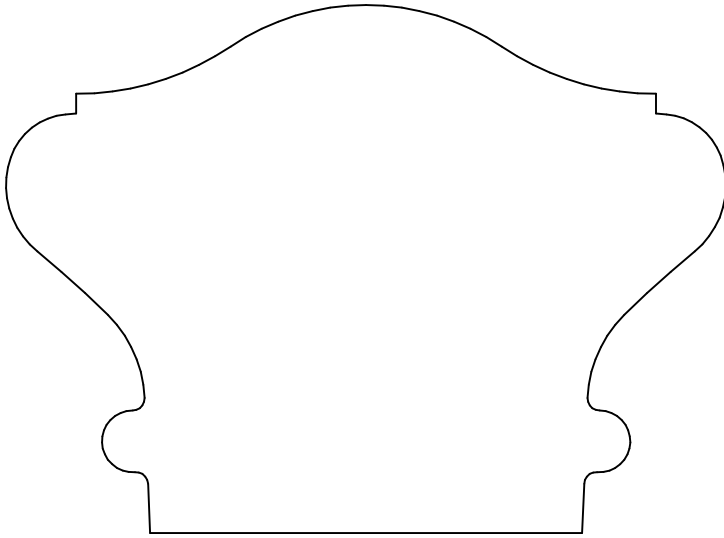

**KL 5910**  
2.750 x 3.750

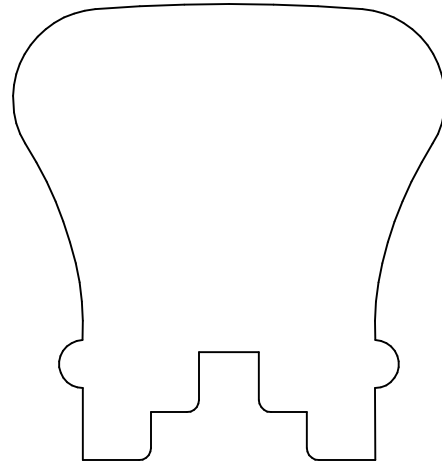

**KL 5915P**  
2.375 x 2.250

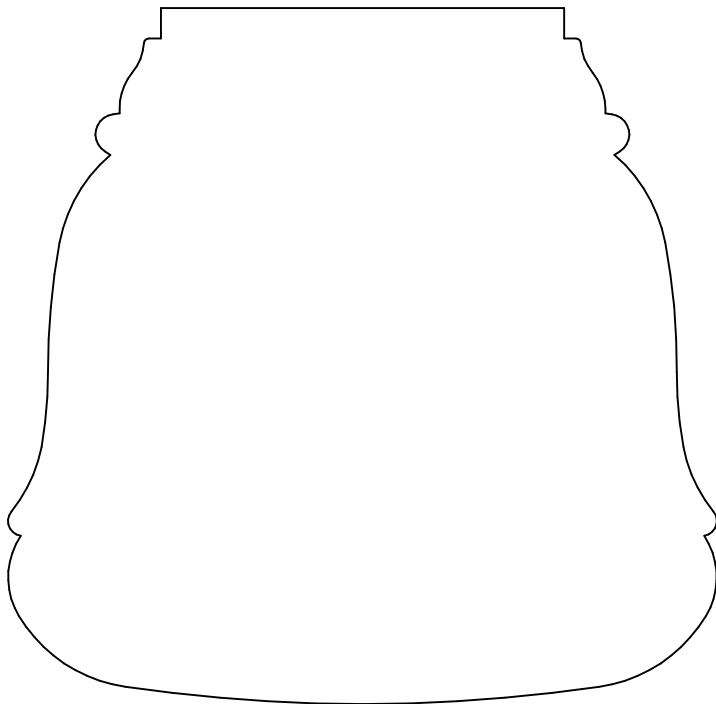

**KL 5911**  
3.625 x 3.690

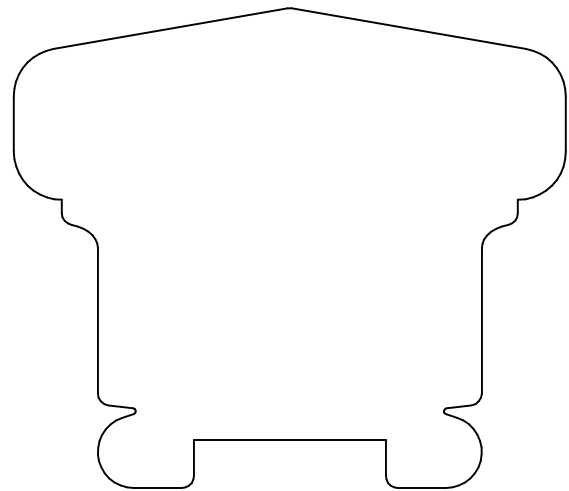

**KL 5916P**  
2.500 x 2.875

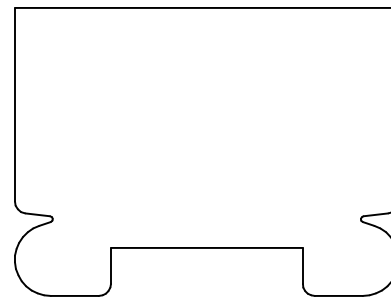

**KL 5917P**  
1.500 x 2.000



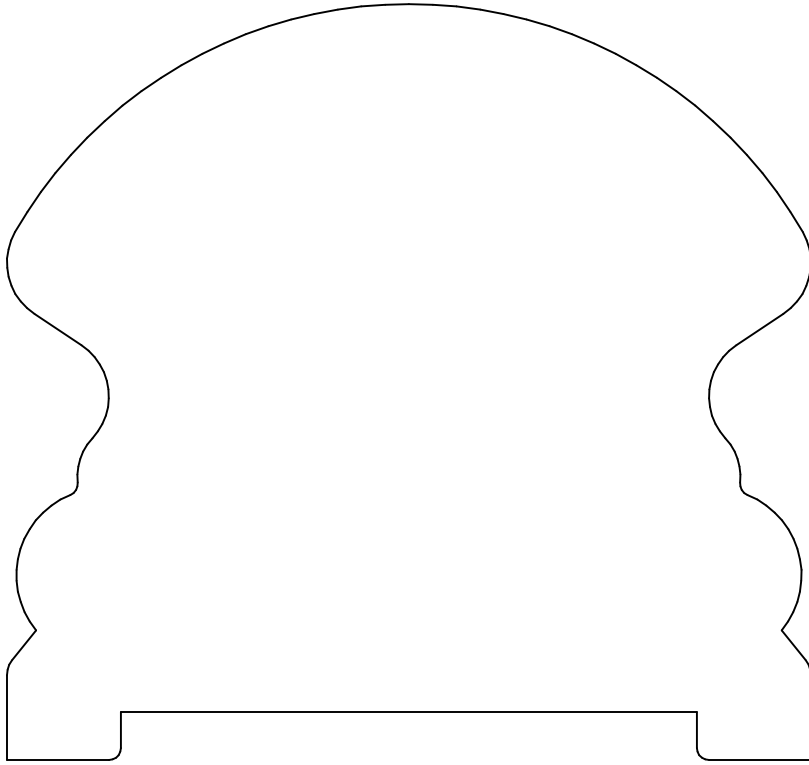

**KL 5912P**  
3.937 x 4.187

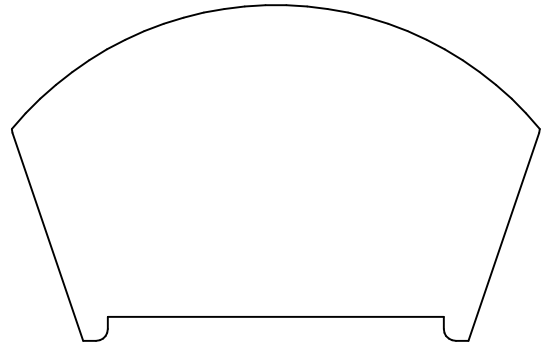

**KL 5919P**  
1.750 x 2.750

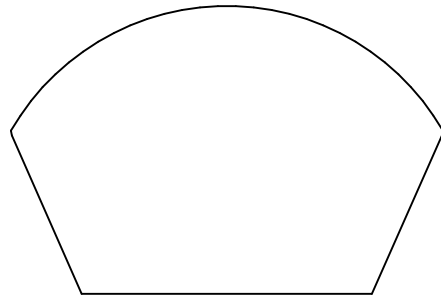

**KL 5920**  
1.500 x 2.250

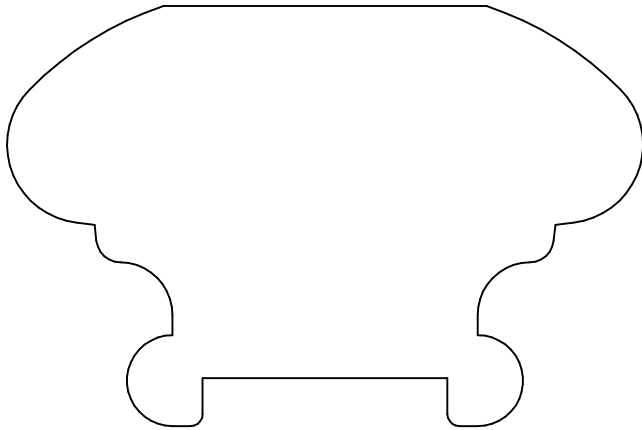

**KL 5913P**  
2.187 x 3.312

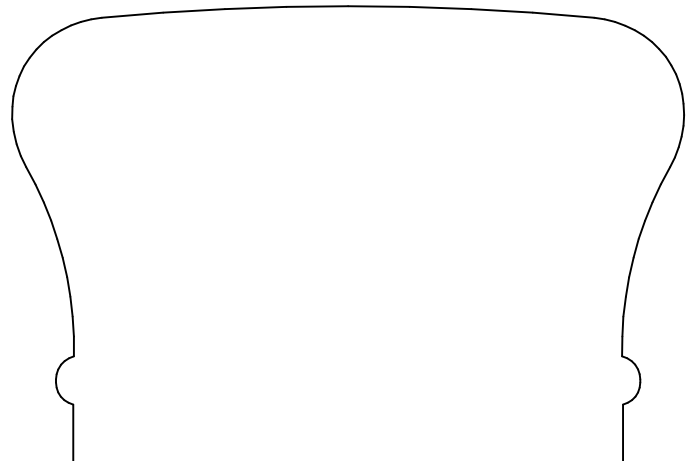

**KL 5914**  
2.375 x 3.500

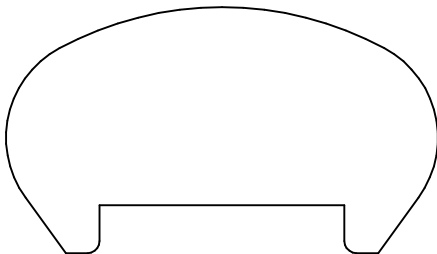

**KL 5934P**  
1.281 x 2.250

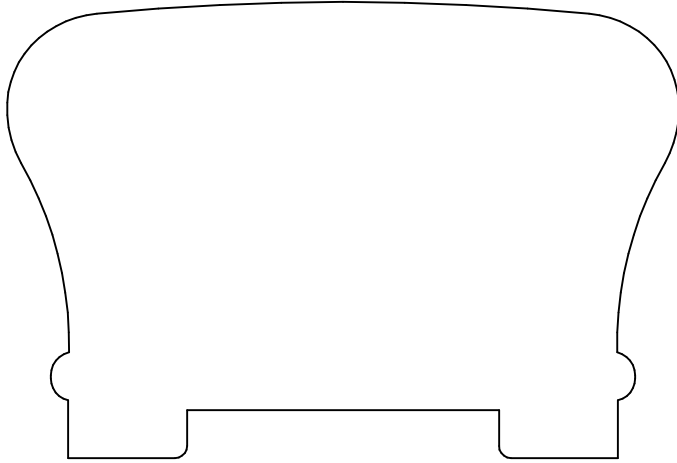

**KL 5914P**  
2.375 x 3.500

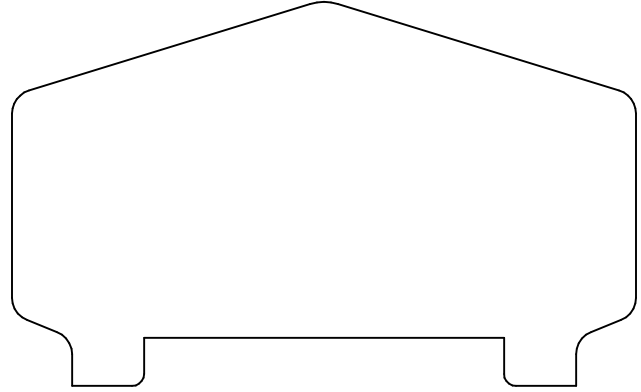

**KL 5922P**  
2.000 x 3.250

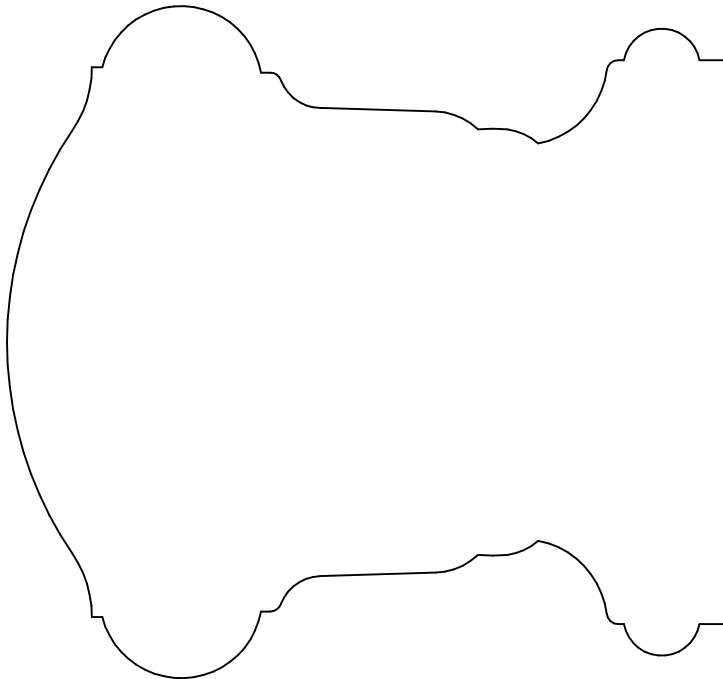

**KL 5918**  
3.750 x 3.500

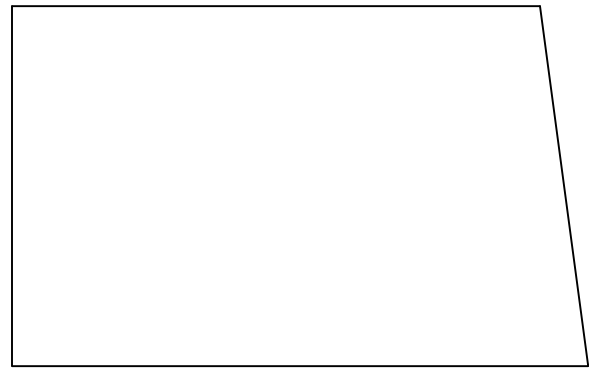

**KL 5923**  
1.875 x 3.000

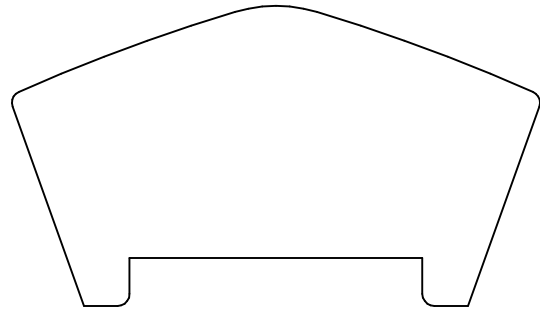

**KL 5924P**  
1.563 x 2.750

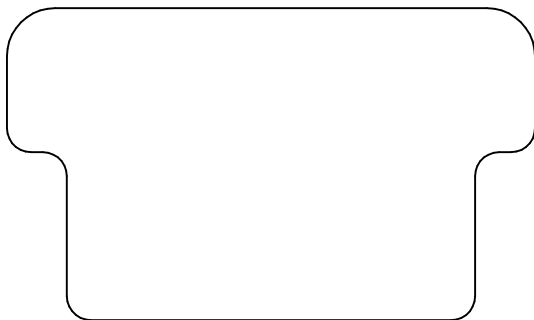

**KL 5927**  
1.625 x 2.750

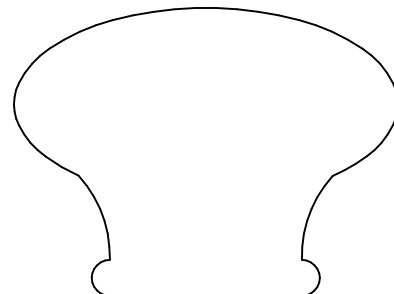

**KL 5928**  
1.500 x 2.000

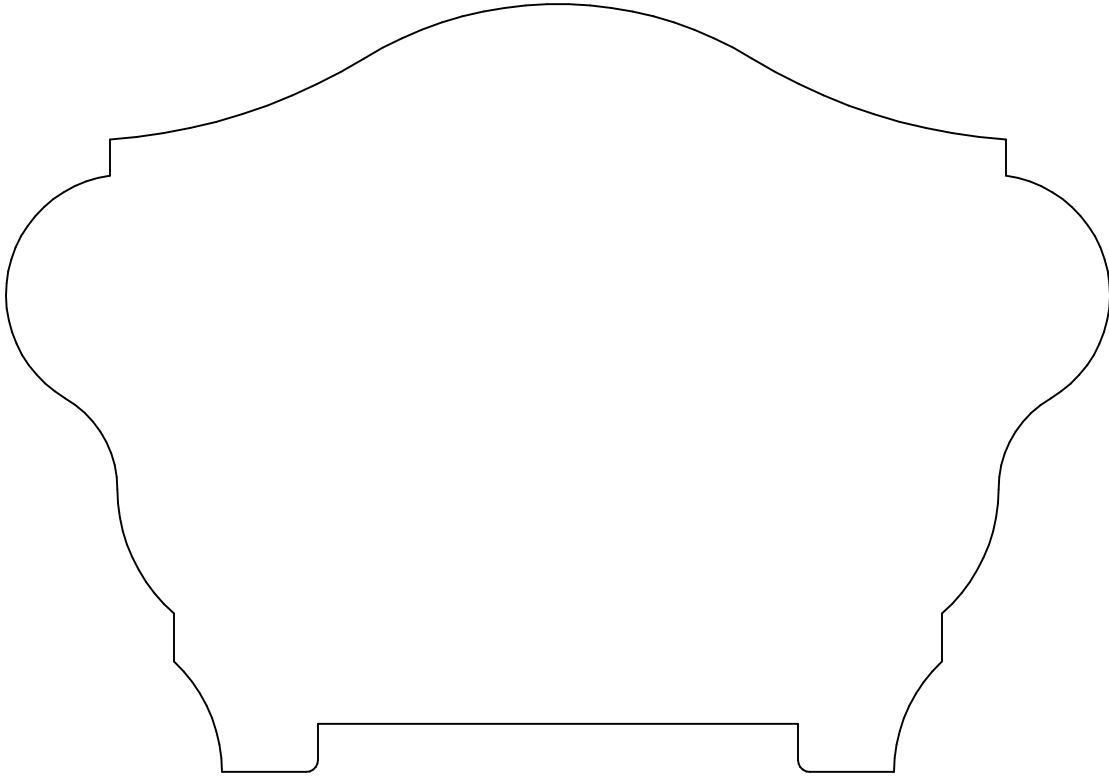

**KL 5921P**  
4.000 x 5.750

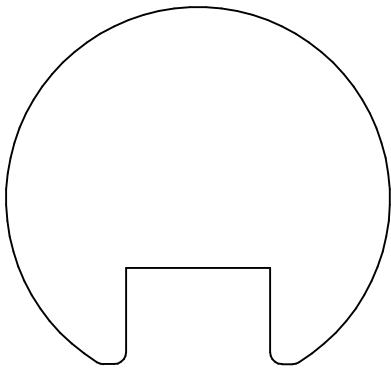

**KL 5925P**  
1.860 x 2.000

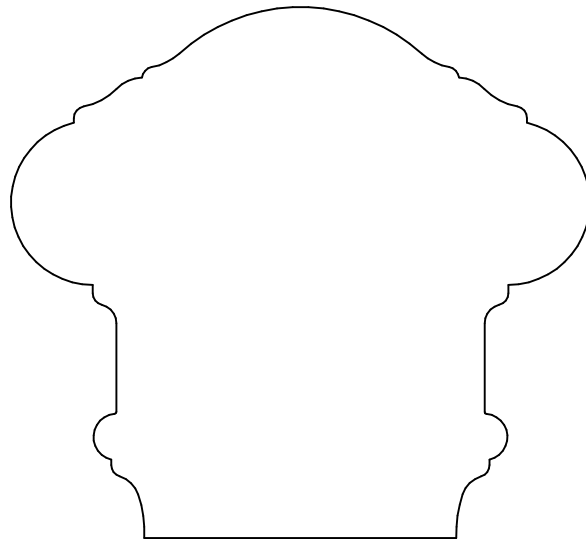

**KL 5926**  
2.765 x 3.015

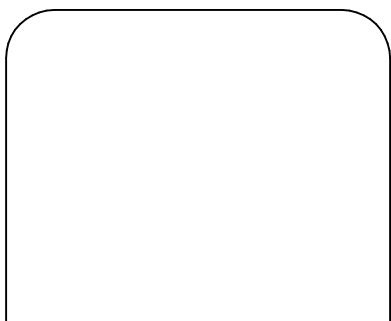

**KL 5935**  
1.625 x 2.000

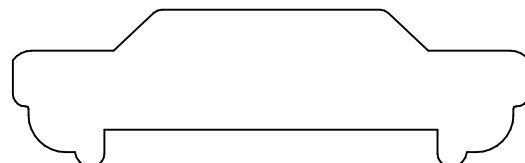

**KL 5937P**  
.812 x 2.687

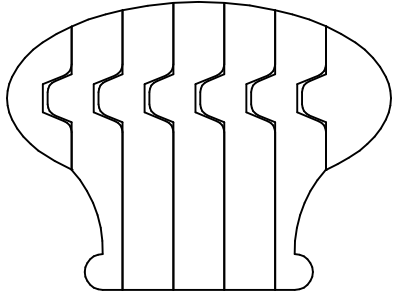

**KL 5928B**  
1.875 x 2.000

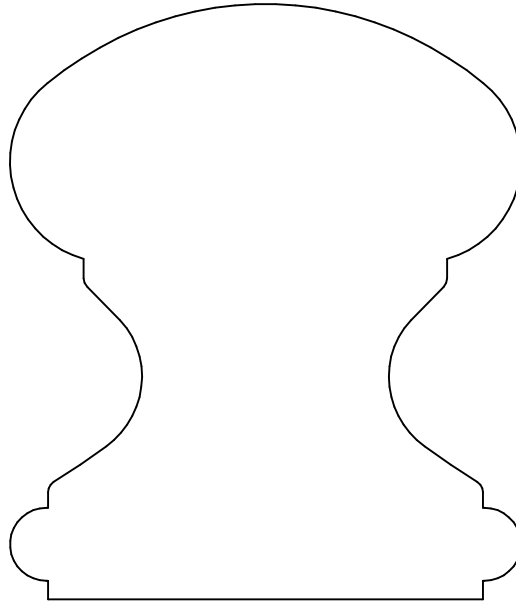

**KL 5929**  
3.100 x 2.661

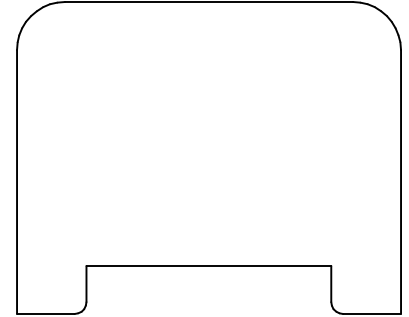

**KL 5935P**  
1.625 x 2.000

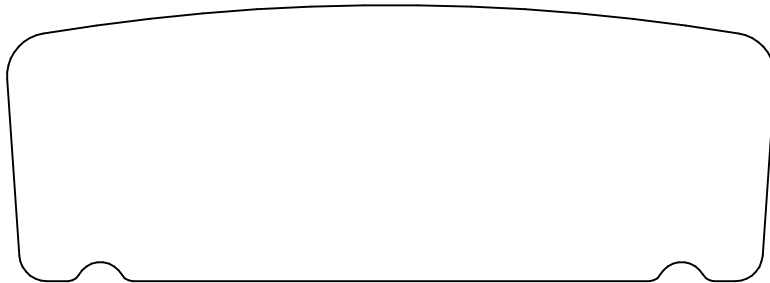

**KL 5930**  
1.437 x 4.000

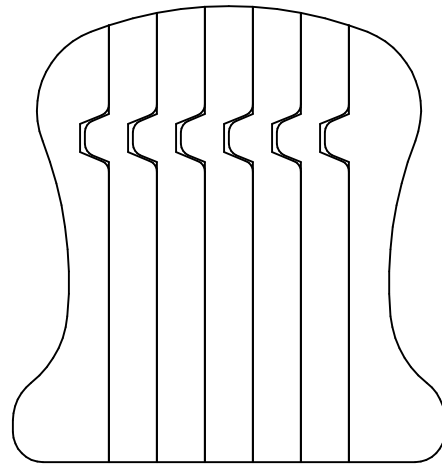

**KL 5936B**  
1.187 x 1.125

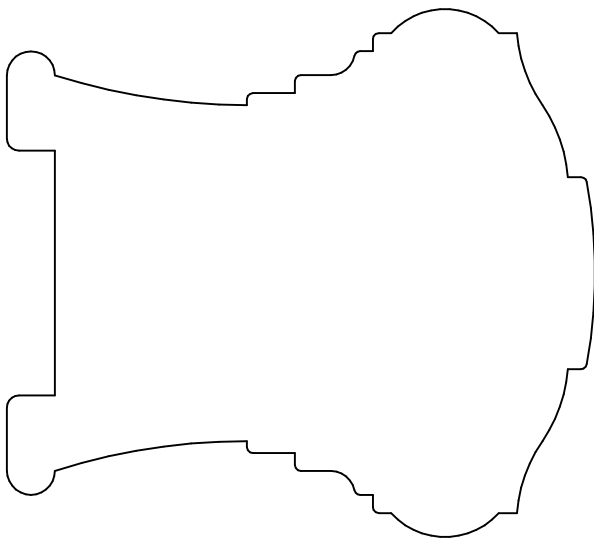

**KL 5933P**  
3.062 x 2.750

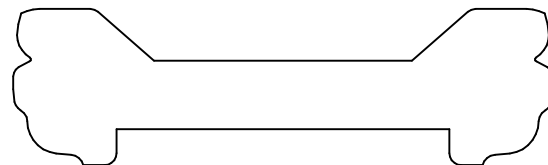

**KL 5938P**  
.813 x 2.813

# CUSTOM PROFILES

# Handrail

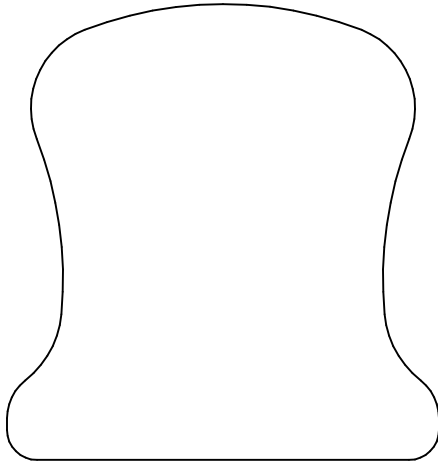

**KL 5936**  
2.375 x 2.250

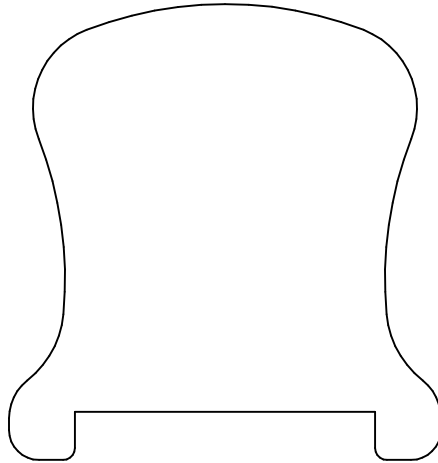

**KL 5936P**  
2.375 x 2.250

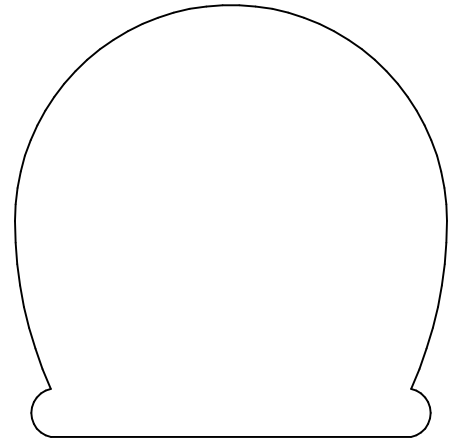

**KL 5943**  
2.250 x 2.250

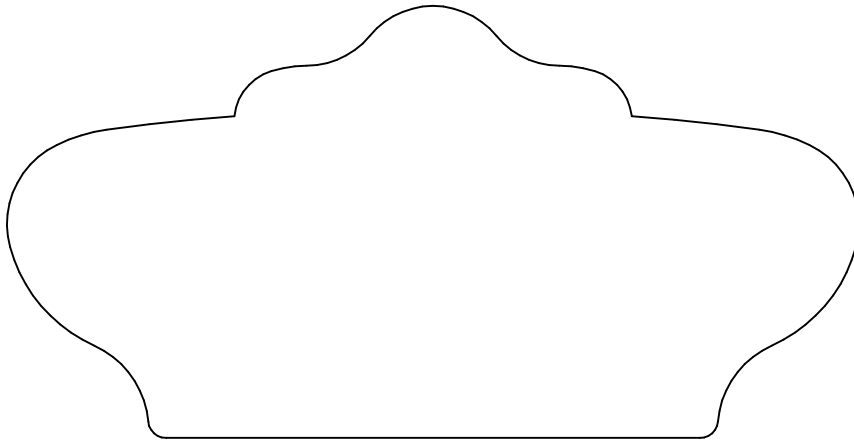

**KL 5939**  
2.250 x 4.438

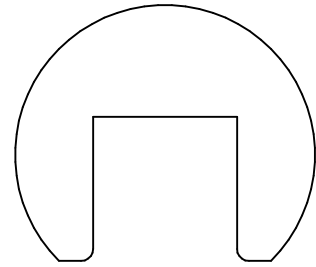

**KL 5946P**  
1.333 x 1.562

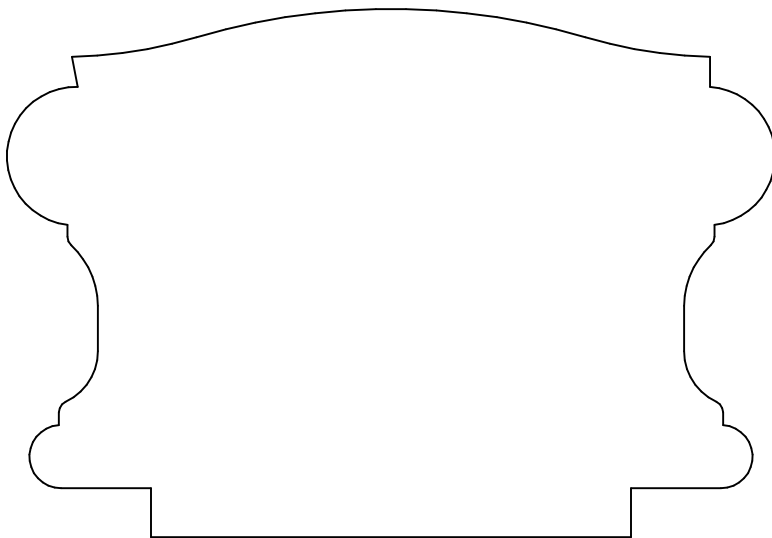

**KL 5940**  
2.750 x 4.000

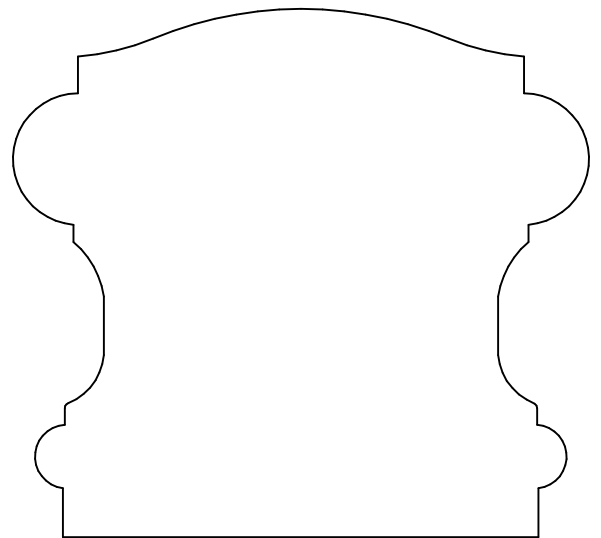

**KL 5952P**  
2.750 x 3.000

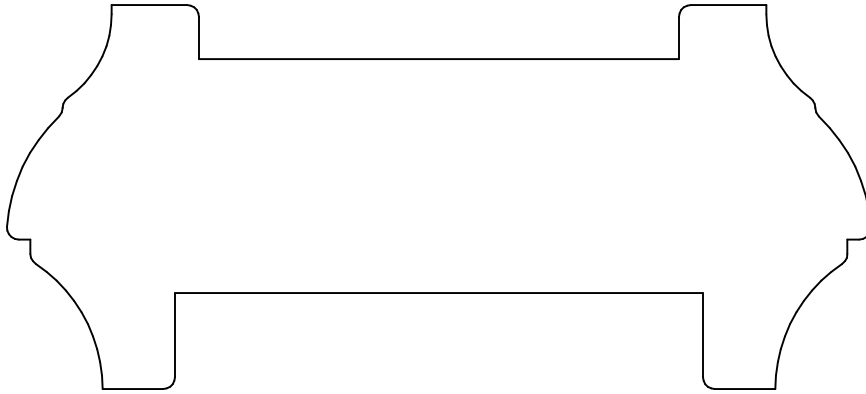

**KL 5941P**  
2.000 x 4.500

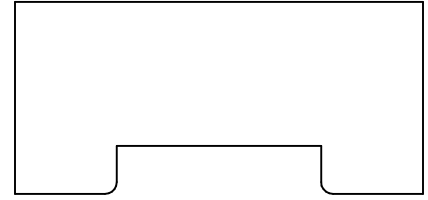

**KL5949P**  
1.000 x 2.125

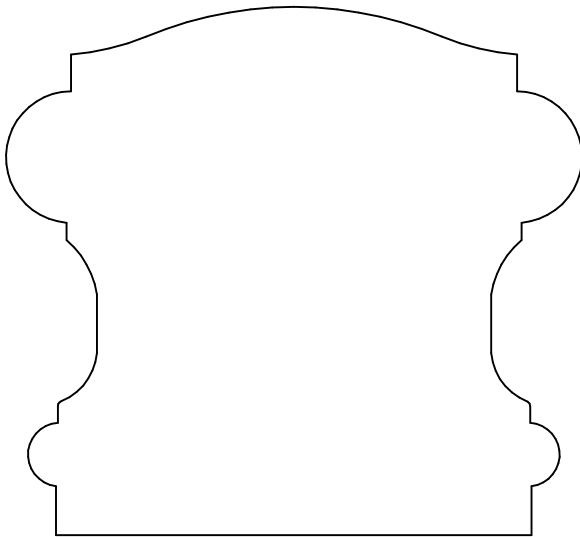

**KL 5942**  
2.750 x 3.000

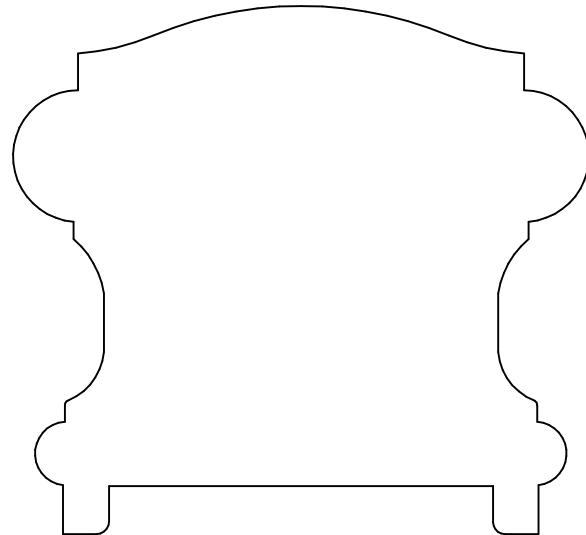

**KL 5942P**  
2.750 x 3.000

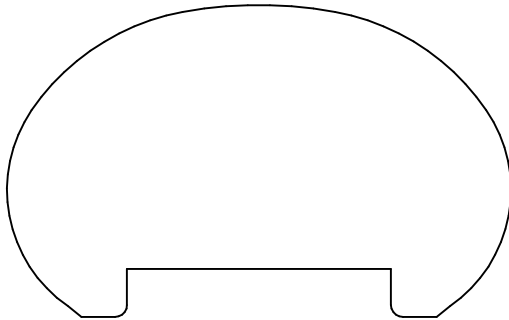

**KL 5945P**  
1.625 x 2.625

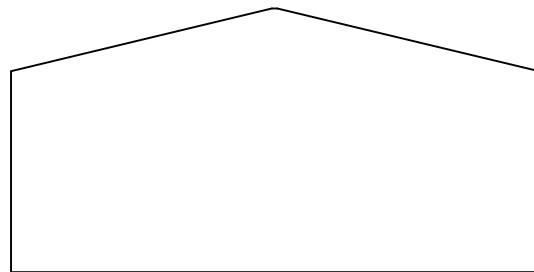

**KL 5948**  
1.375 x 2.750

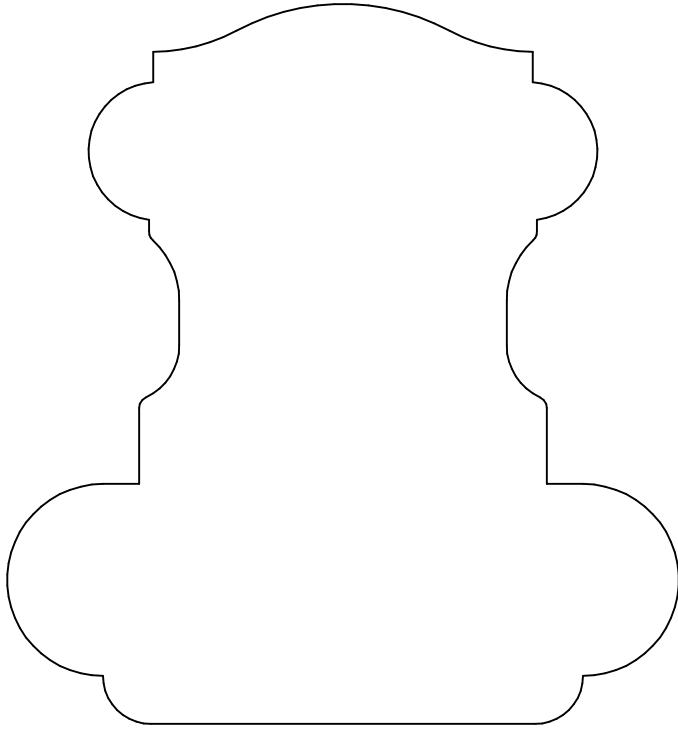

**KL 5944**  
3.750 x 3.500

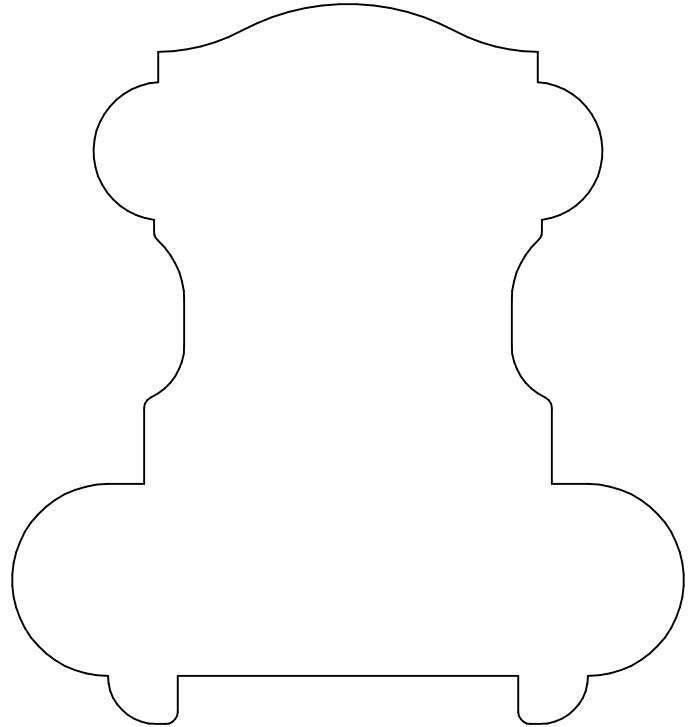

**KL 5944P**  
3.750 x 3.500

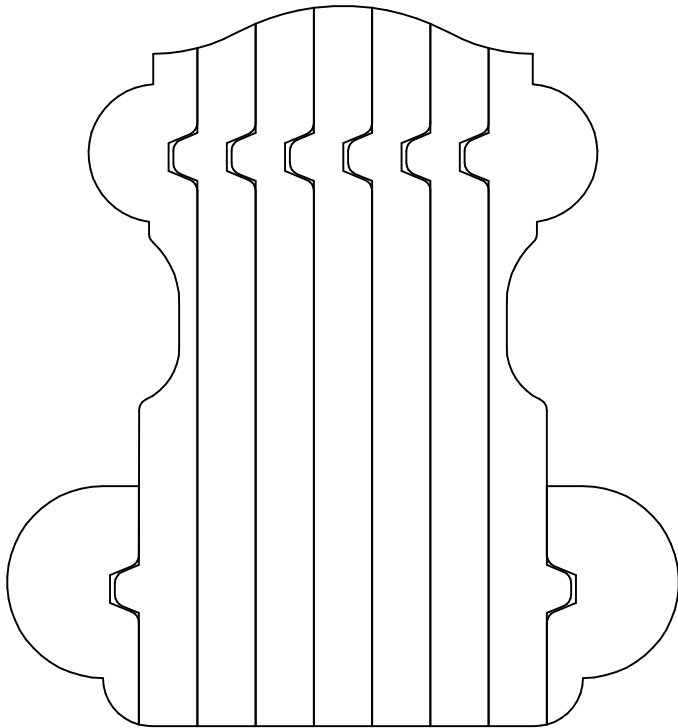

**KL 5944B**  
3.750 x 3.500

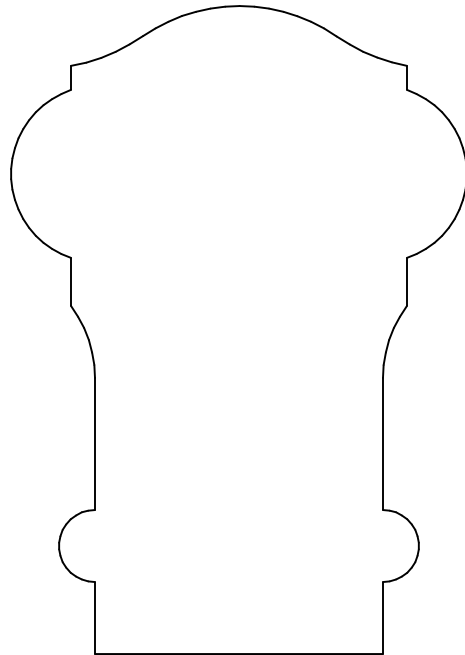

**KL 5950**  
3.375 x 2.375

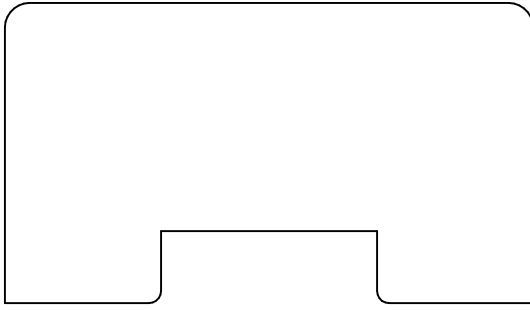

**KL 5951P**  
1.563 x 2.750



**KL 5952P**  
1.562 x 2.750

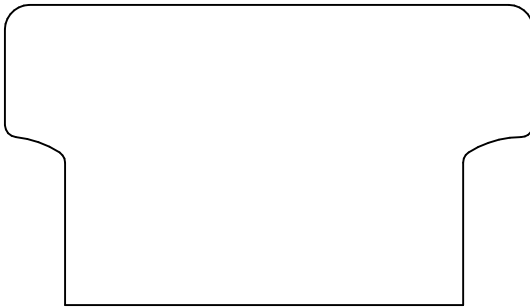

**KL 5953**  
1.562 x 2.750

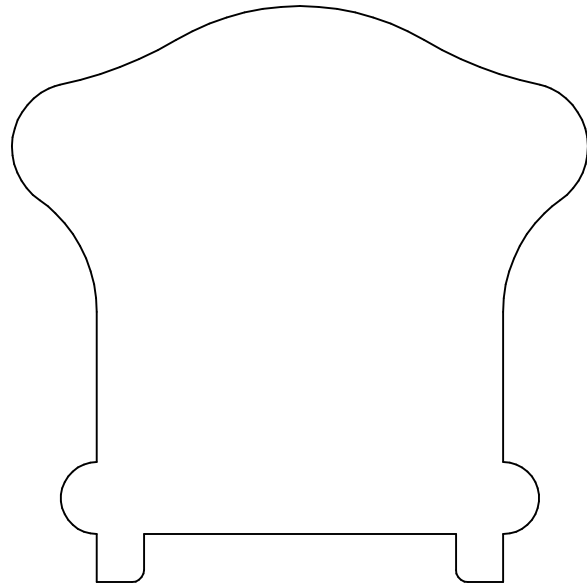

**KL 5954P**  
3.000 x 3.000

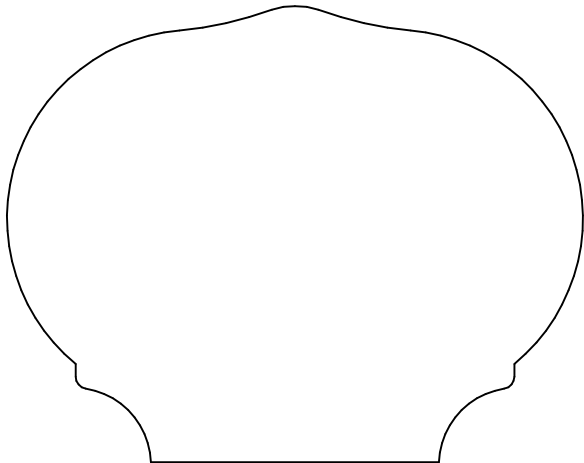

**KL 5955**  
2.375 x 3.000

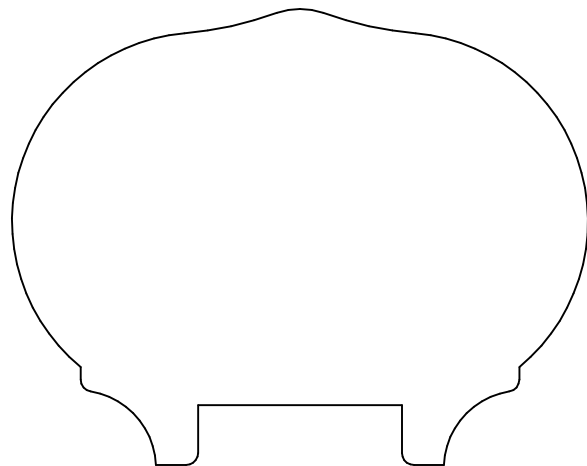

**KL 5955P**  
2.375 x 3.000



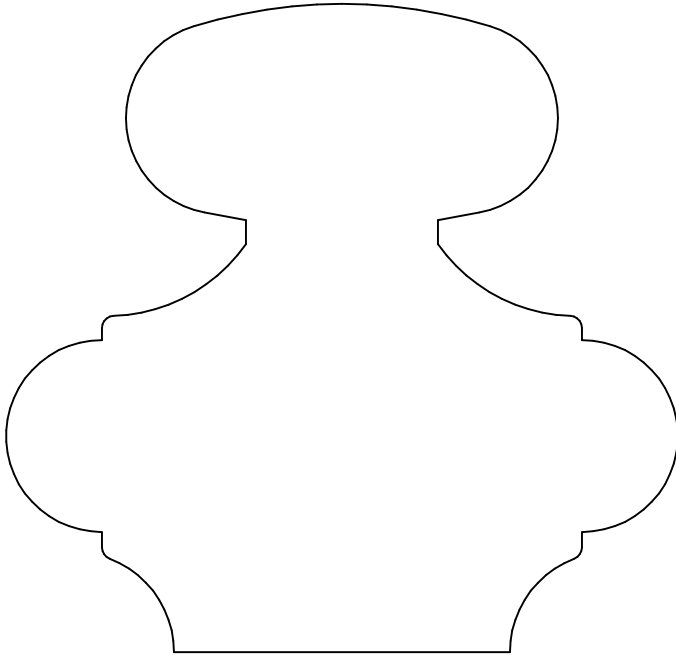

**KL 5956**  
3.375 x 3.500

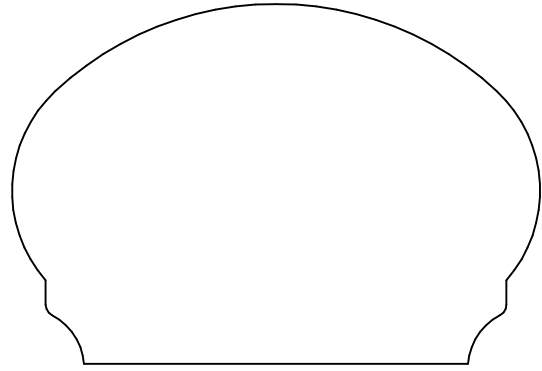

**KL 5957**  
1.875 x 2.750

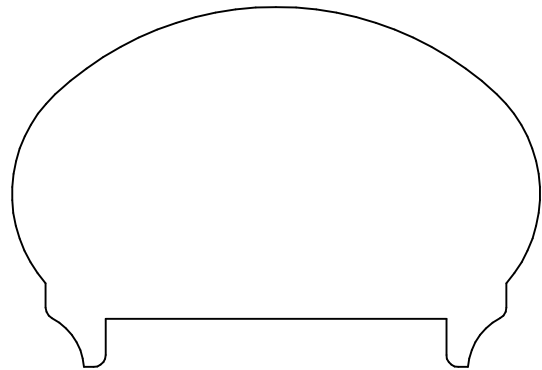

**KL 5957P**  
1.875 x 2.750

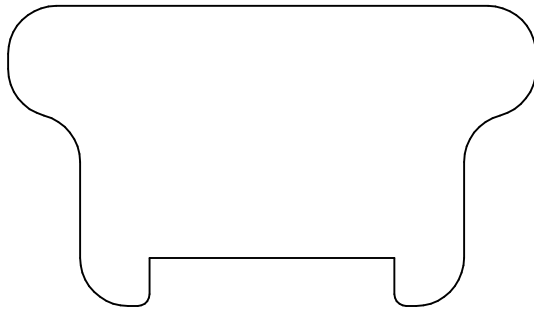

**KL 5958P**  
1.563 x 2.750

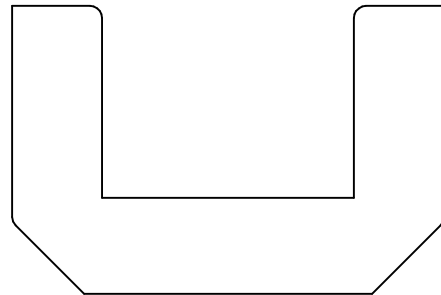

**KL 5959P**  
1.500 x 2.250

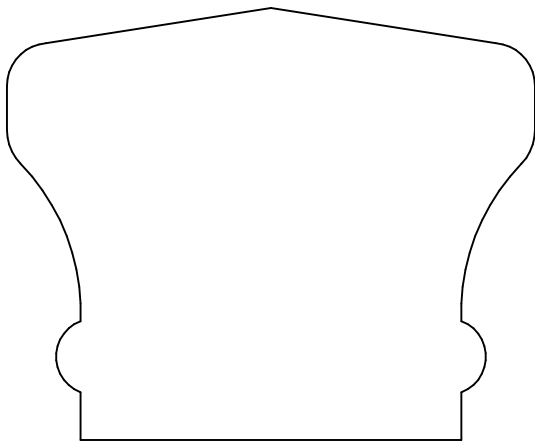

**KL 5960**  
2.250 x 2.750

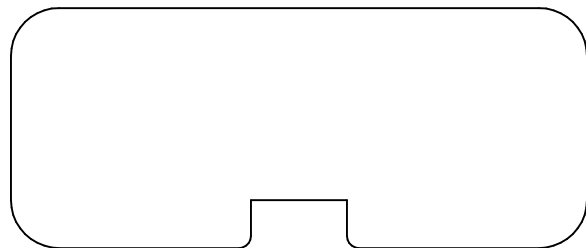

**KL 5962P**  
1.250 x 3.000

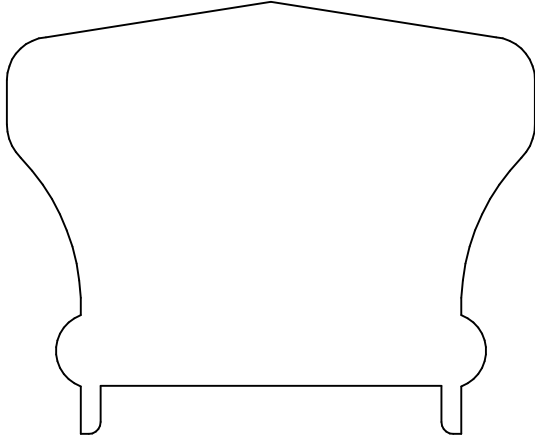

**KL 5960P**  
2.250 x 2.750

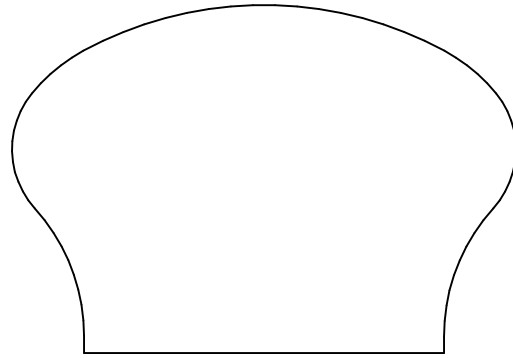

**KL 5965**  
1.813 x 2.625

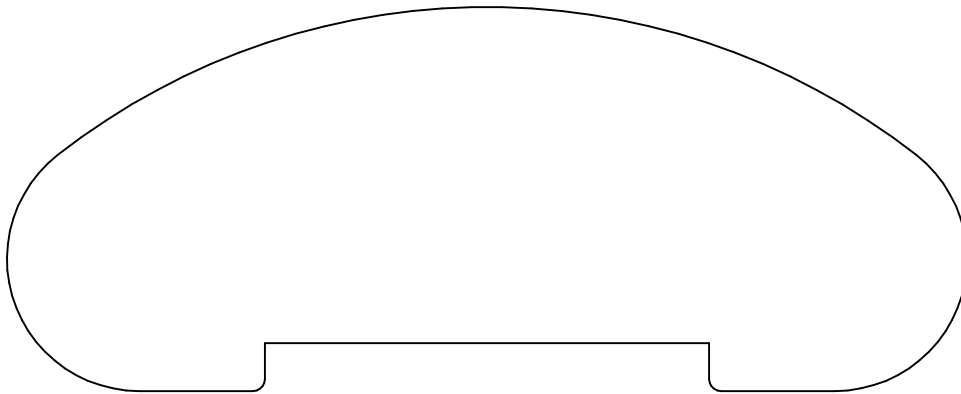

**KL 5961P**  
2.000 x 5.000

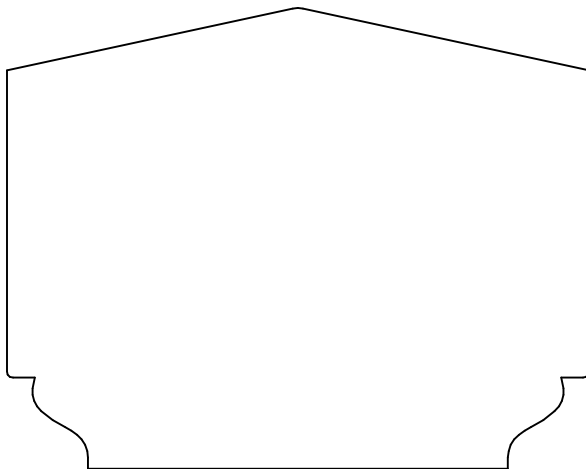

**KL 5963**  
2.400 x 3.031

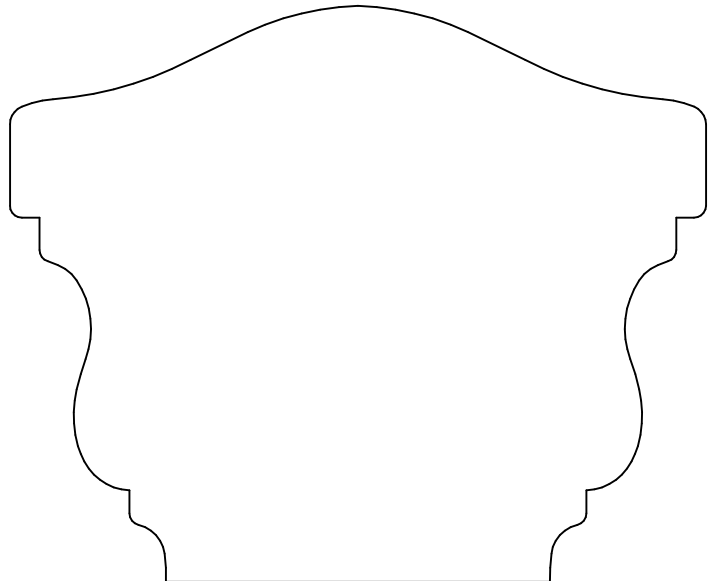

**KL 5964**  
3.000 x 3.625



**KL 5966**  
2.000 x 5.500

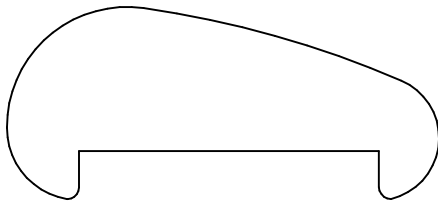

**KL 5967P**  
1.000 x 2.250

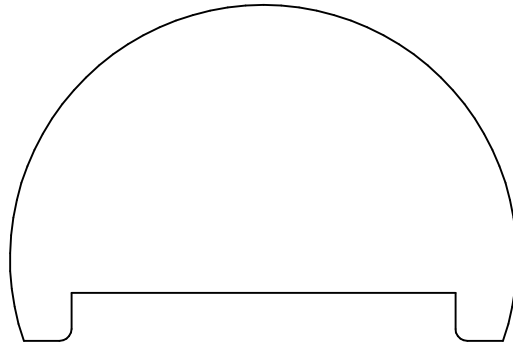

**KL 5968P**  
1.750 x 2.640

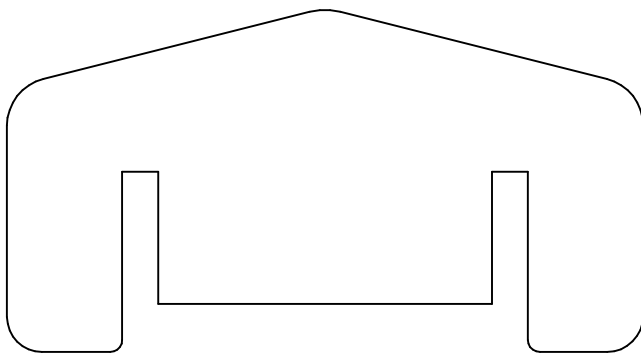

**KL 5969P**  
1.781 x 3.313

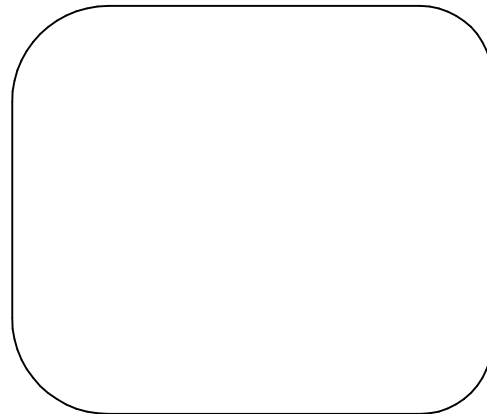

**KL 5971**  
2.125 x 2.500

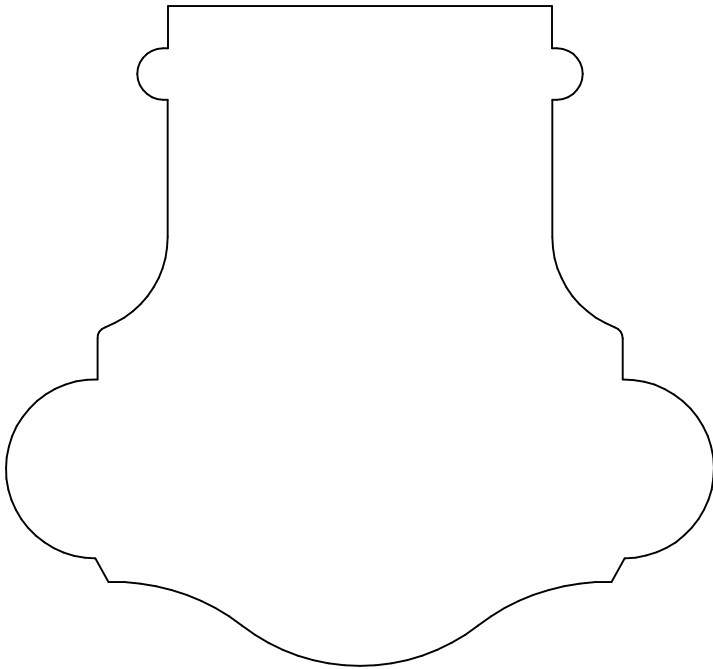

**KL 5970**  
3.437 x 3.688

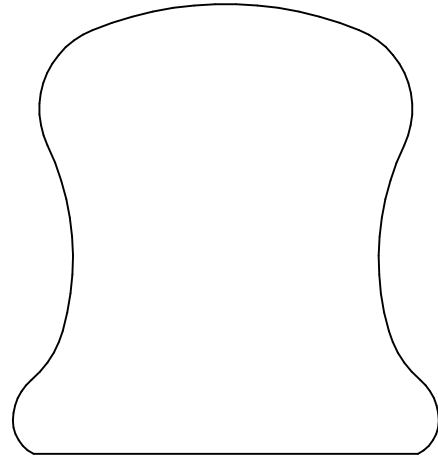

**KL 5973**  
2.343 x 2.218

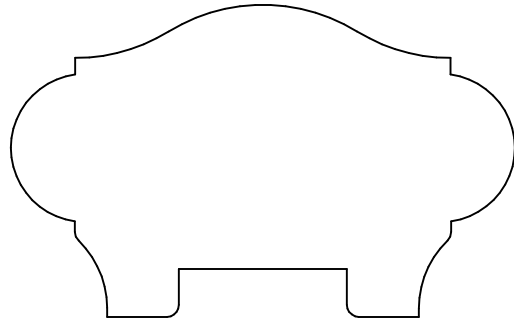

**KL 5974P**  
1.625 x 2.625

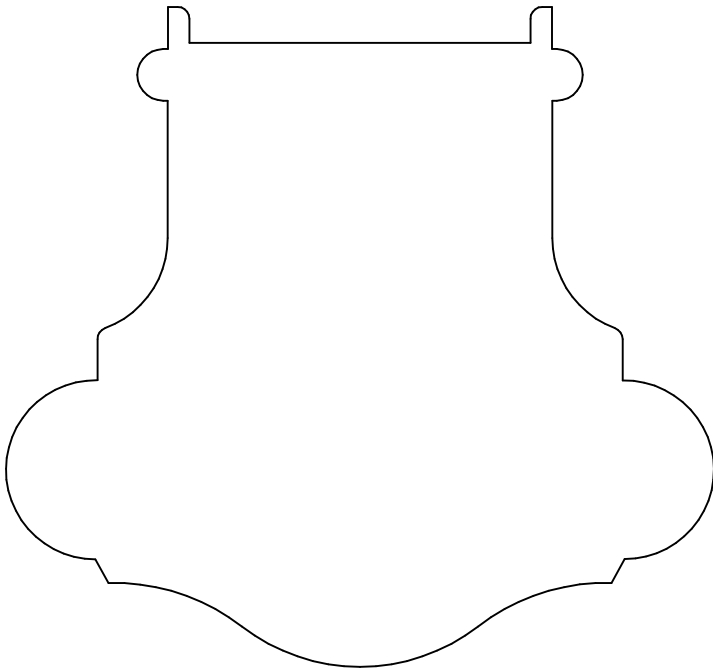

**KL 5970P**  
3.437 x 3.688

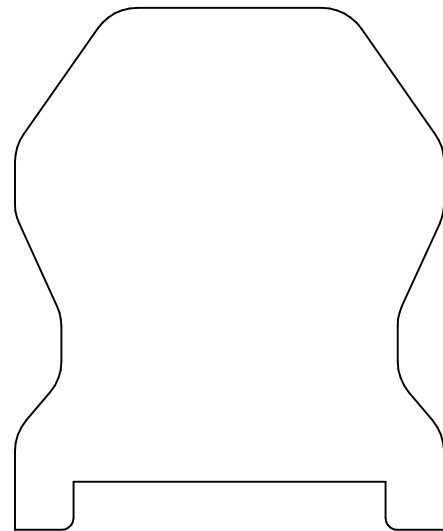

**KL 5975P**  
2.719 x 2.234

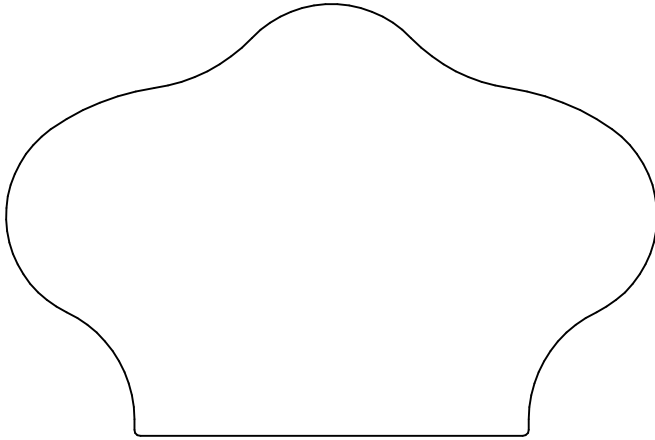

**KL 5972**  
2.250 x 3.391

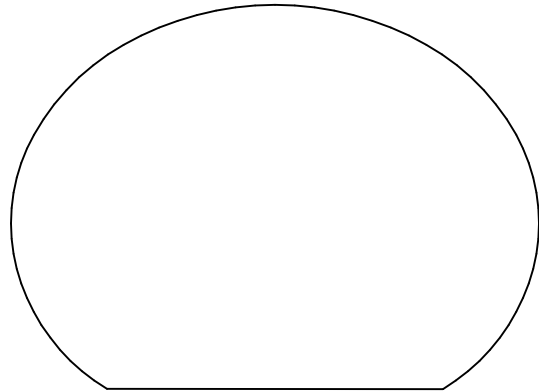

**KL 5988**  
2.000 x 2.750

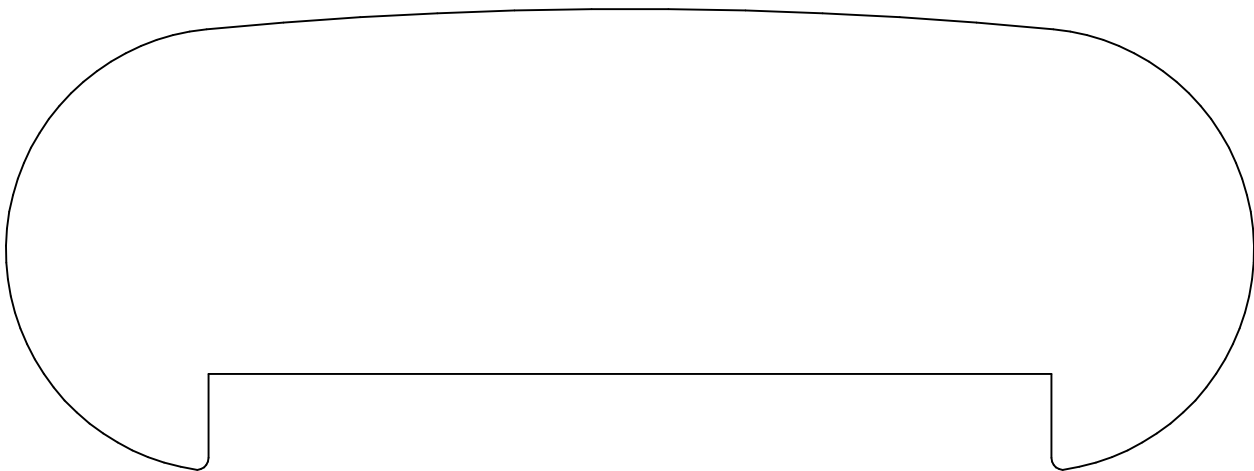

**KL 5976P**  
2.400 x 6.500

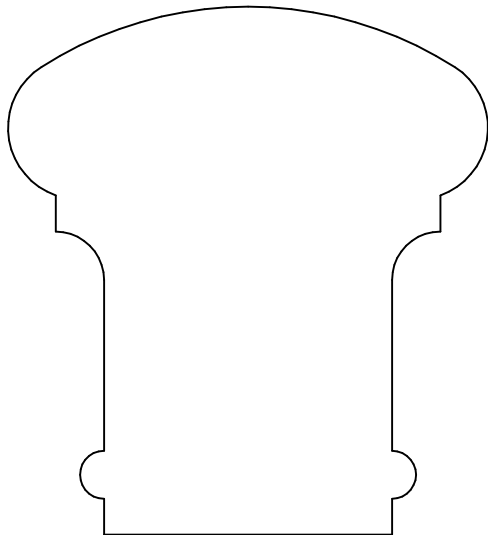

**KL 5977**  
2.750 x 2.500

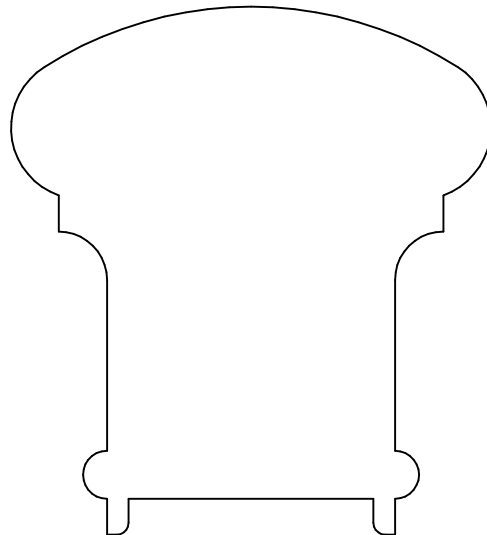

**KL 5977P**  
2.750 x 2.500

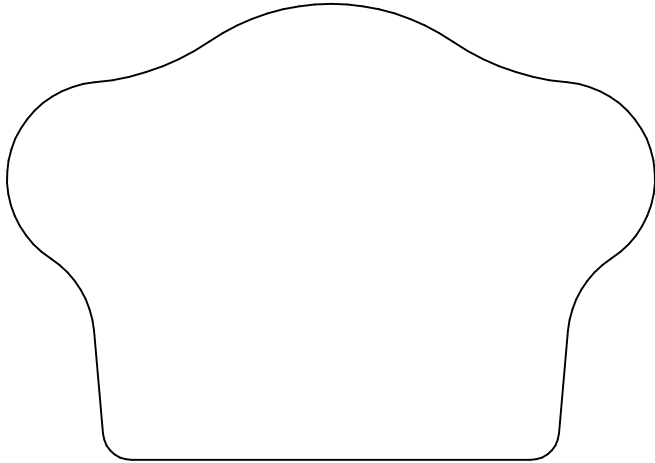

**KL 5978**  
2.375 x 3.375

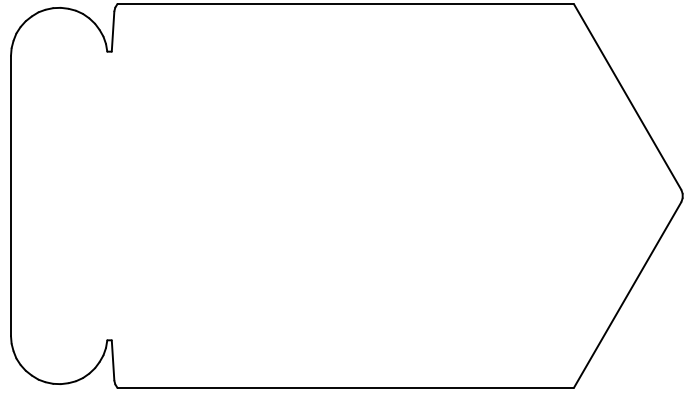

**KL 5980**  
2.000 x 3.500

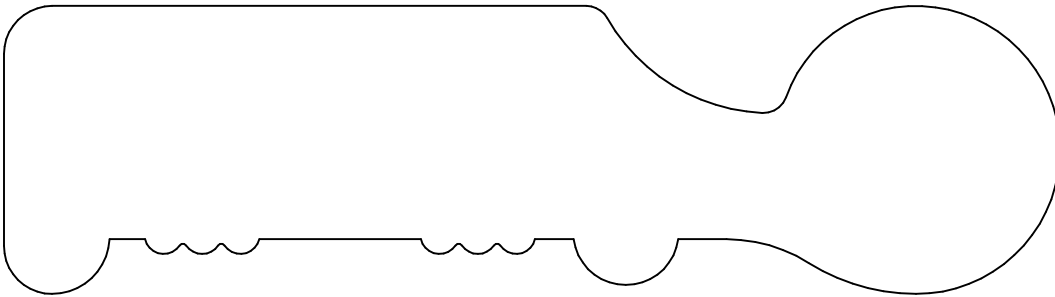

**KL 5979**  
1.500 x 5.500

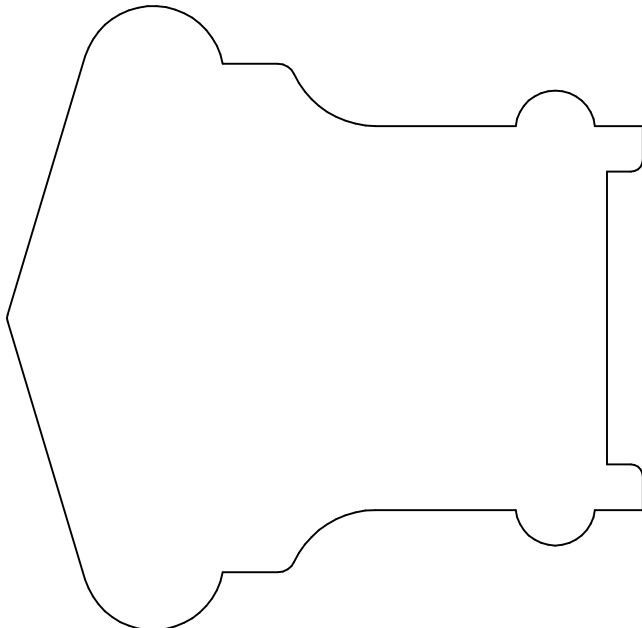

**KL 5981P**  
3.312 x 3.250

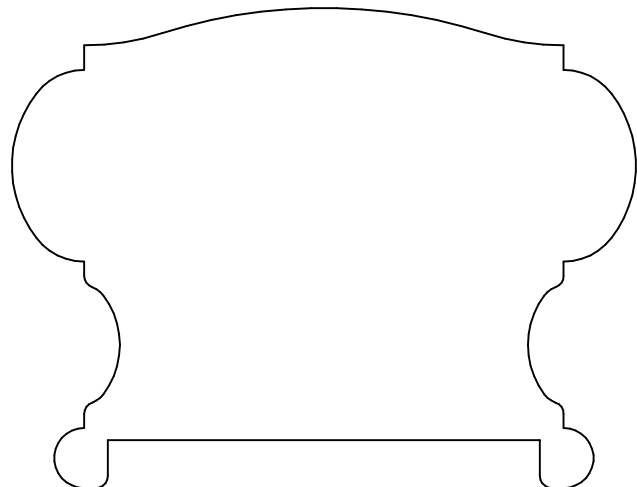

**KL 5983P**  
2.500 x 3.250

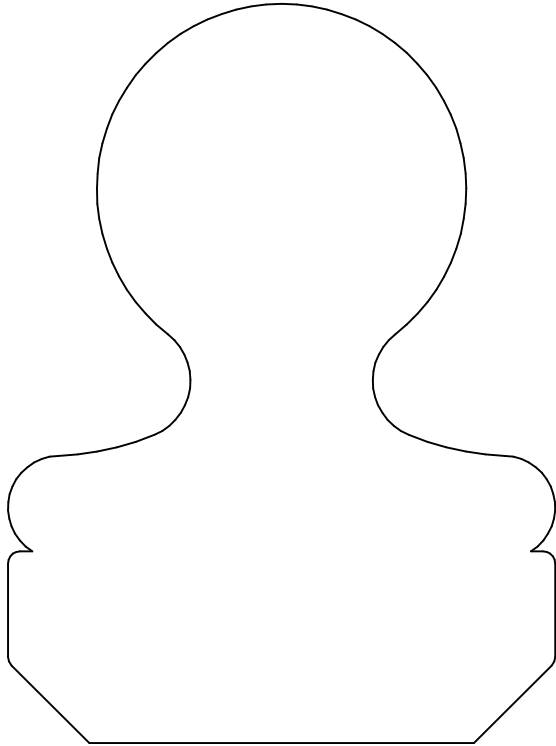

**KL 5982**  
3.850 x 2.850

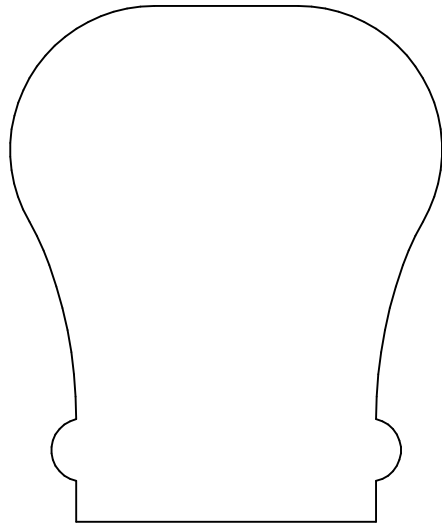

**KL 5984**  
2.687 x 2.250

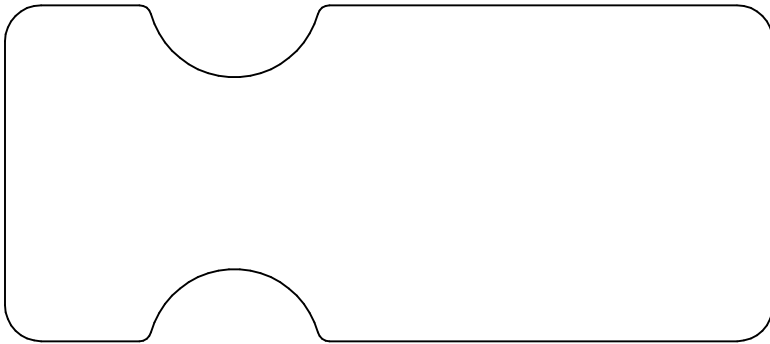

**KL 5985**  
1.750 x 4.000

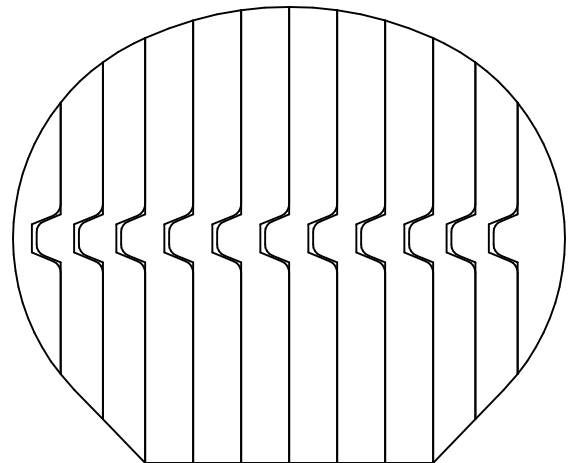

**KL 5986B**  
2.500 x 3.500

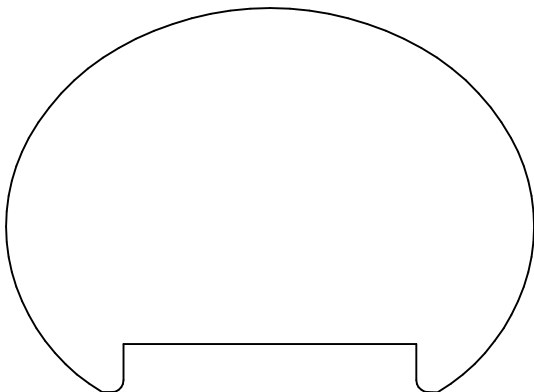

**KL 5988P**  
2.000 x 2.750

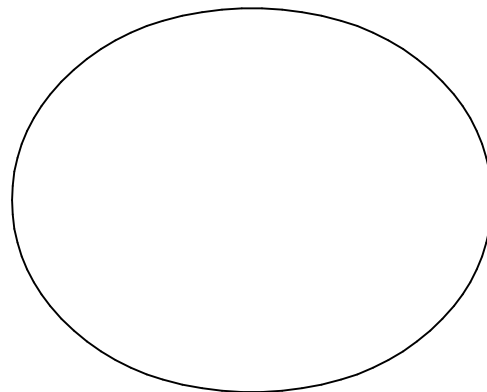

**KL 5990**  
2.000 x 2.500

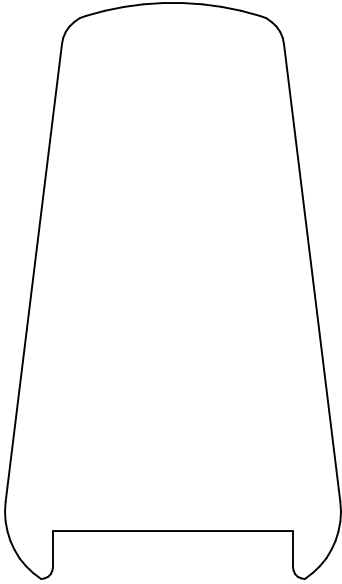

**KL 5987P**  
3.000 x 1.750

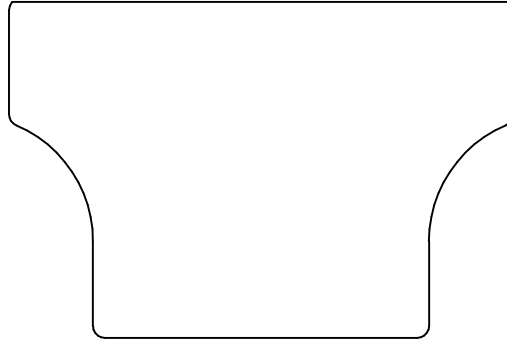

**KL 5991**  
1.750 x 2.625

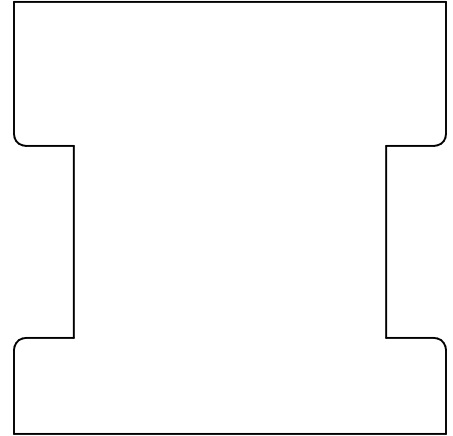

**KL 5993**  
2.250 x 2.250



**KL 5989**  
1.500 x 5.500

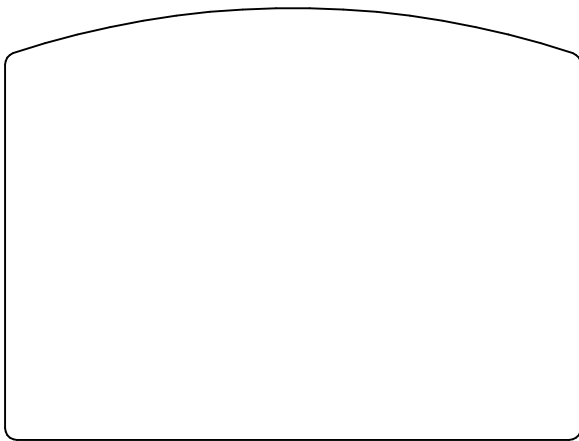

**KL 5992**  
2.250 x 3.000

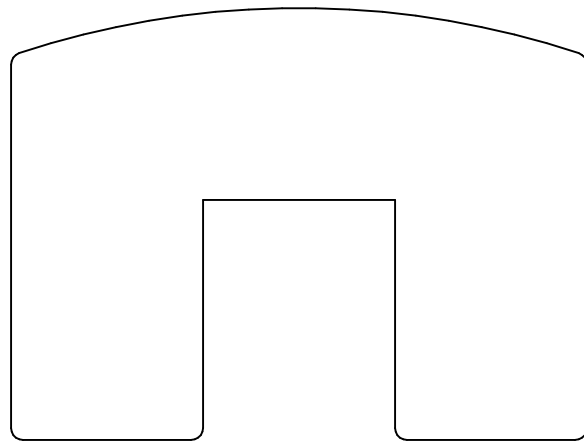

**KL 5992P**  
2.250 x 3.000



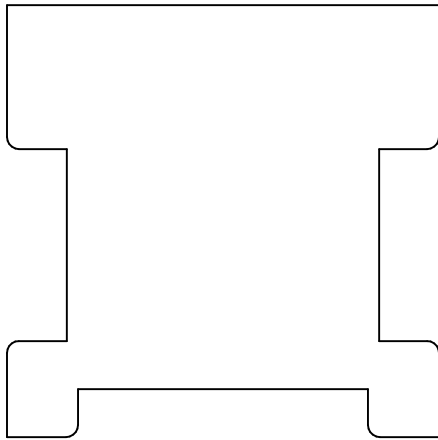

**KL 5993P**  
2.250 x 2.250

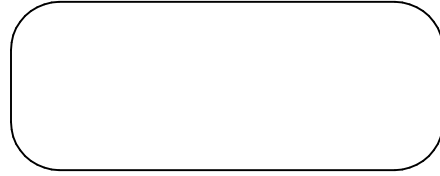

**KL 5994**  
.875 x 2.250

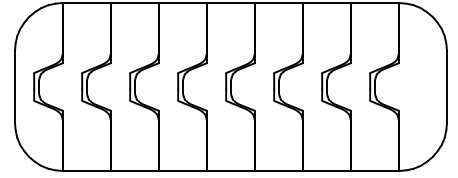

**KL 5994B**  
.875 x 2.250

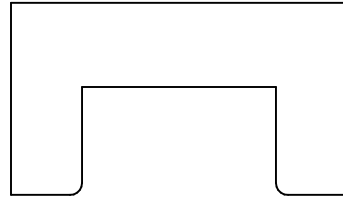

**KL 5995P**  
1.000 x 1.750

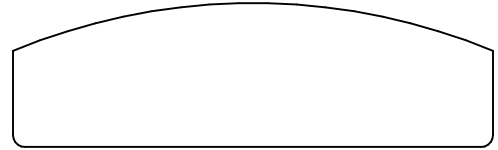

**KL 5996**  
.750 x 2.500

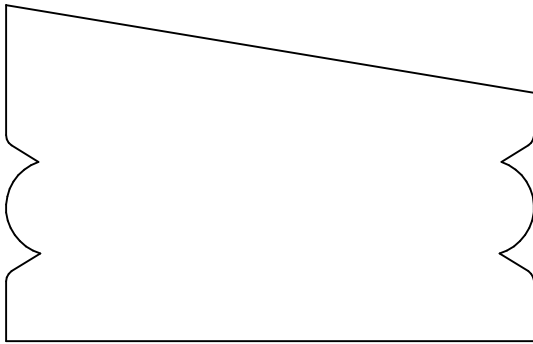

**KL 5997**  
1.750 x 2.750

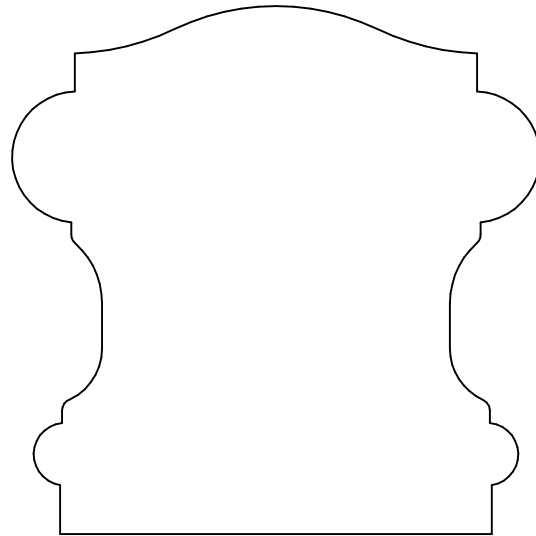

**KL 5998**  
2.750 x 2.750

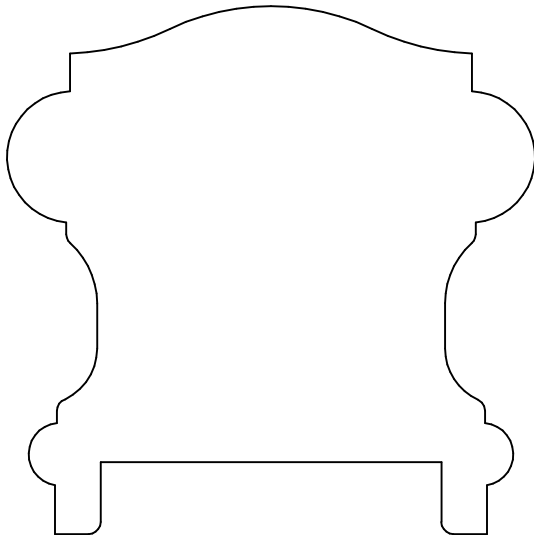

**KL 5998P**  
2.750 x 2.750

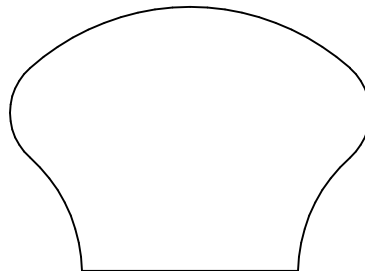

**KL 5999**  
1.375 x 1.875



**KL6903**  
1.000 x 2.000

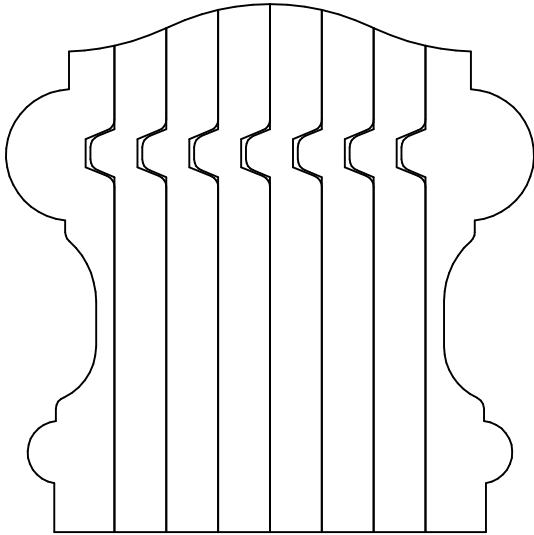

**KL 5998B**  
2.750 x 2.750

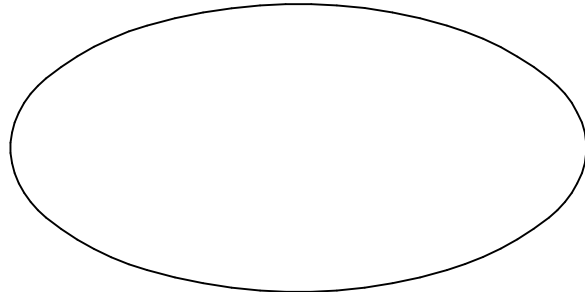

**KL6900**  
1.500 x 3.000

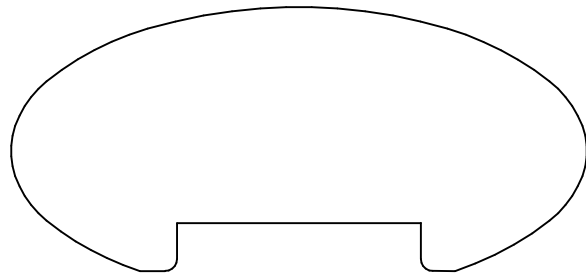

**KL6900P**  
1.375 x 3.000

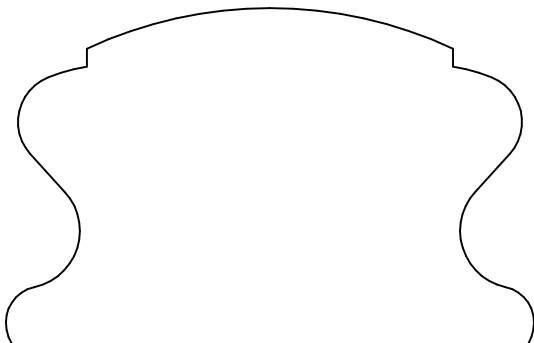

**KL6901**  
1.750 x 2.750

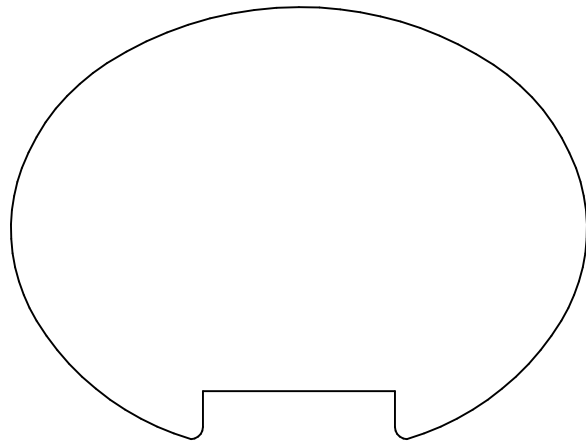

**KL 6902P**  
2.250 x 3.000

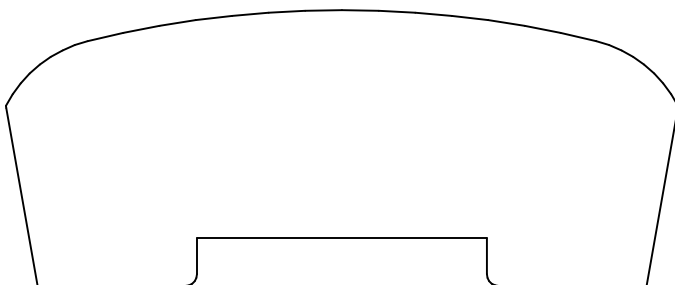

**KL 6904P**  
1.437 x 3.500

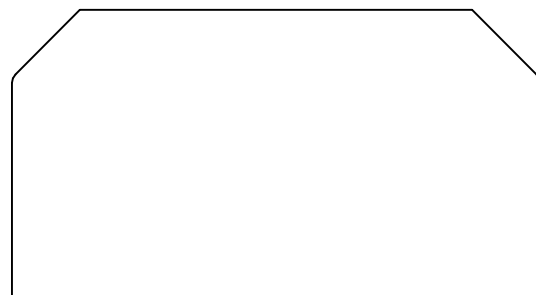

**KL 6906**  
1.500 x 2.750

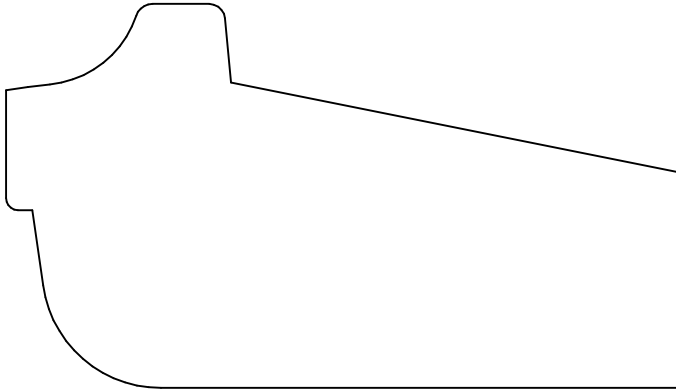

**KL6905**  
2.000 x 3.500

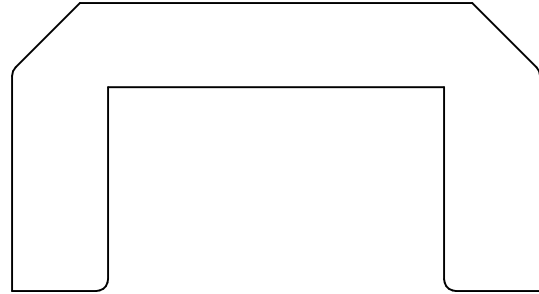

**KL 6906P**  
1.500 x 2.750

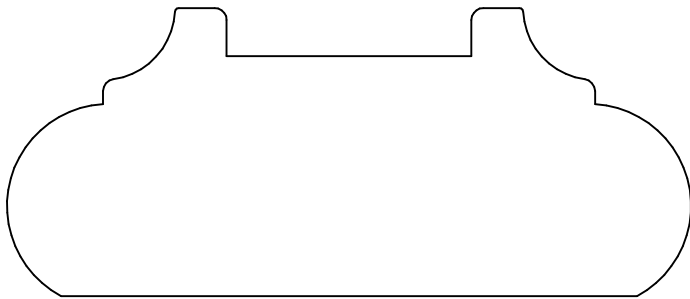

**KL 6907P**  
1.500 x 3.563

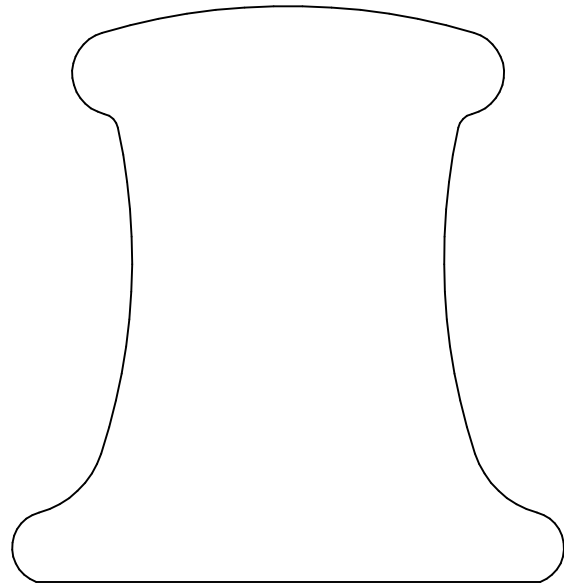

**KL 6908**  
3.000 x 2.875

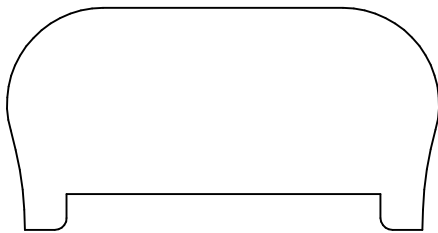

**KL 6909P**  
1.156 x 2.250

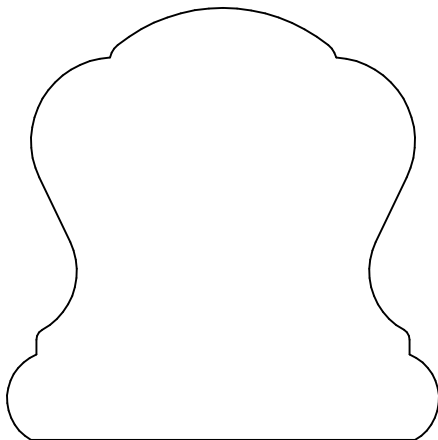

**KL 6910**  
2.250 x 2.250

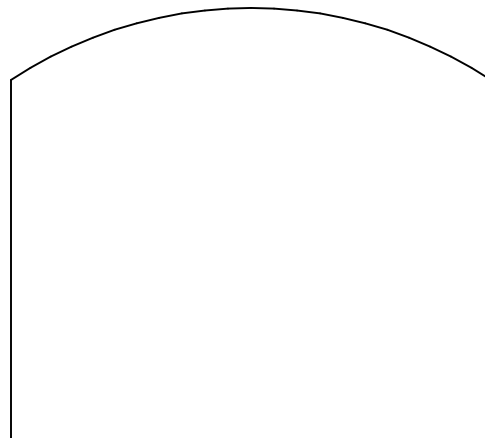

**KL 6912**  
2.250 x 2.500

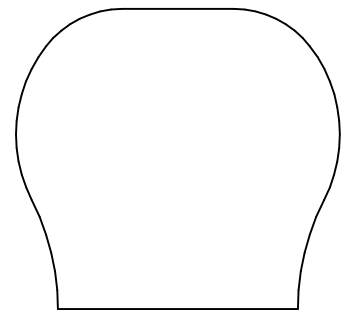

**KL 6920**  
1.562 x 1.687

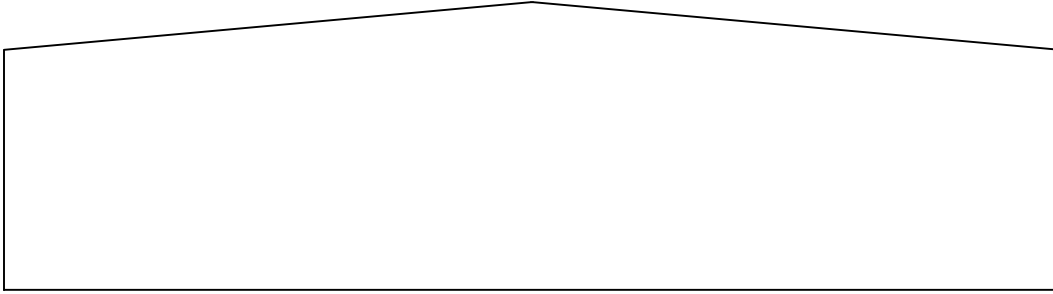

**KL 6911**  
1.500 x 5.500

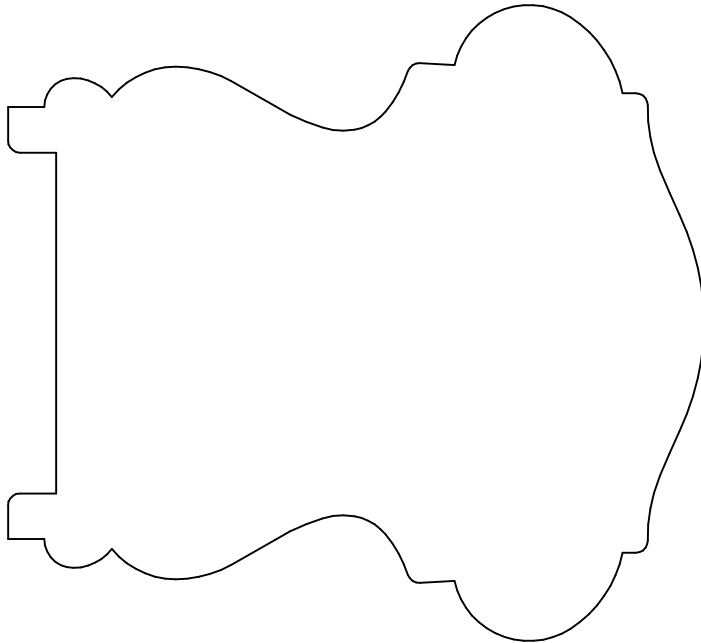

**KL 6913P**  
3.625 x 3.313

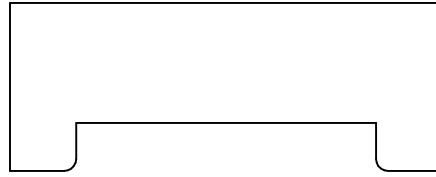

**KL 6914P**  
.875 x 2.250

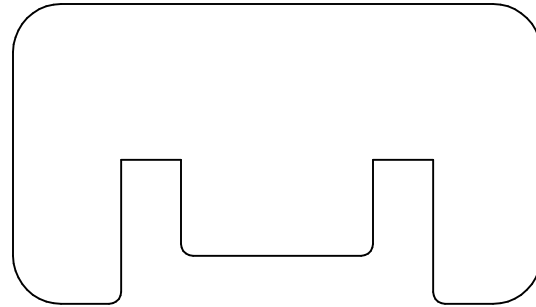

**KL 6915P**  
1.562 x 2.750

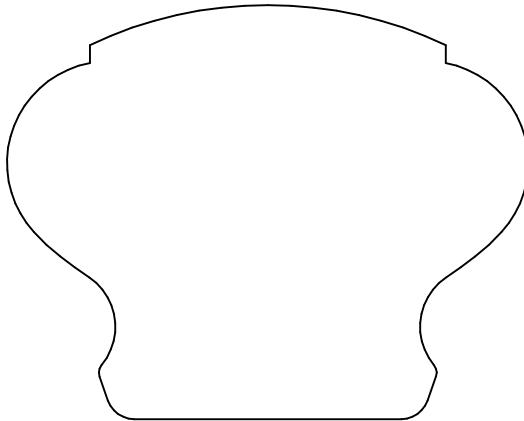

**KL 6916**  
2.157 x 2.716

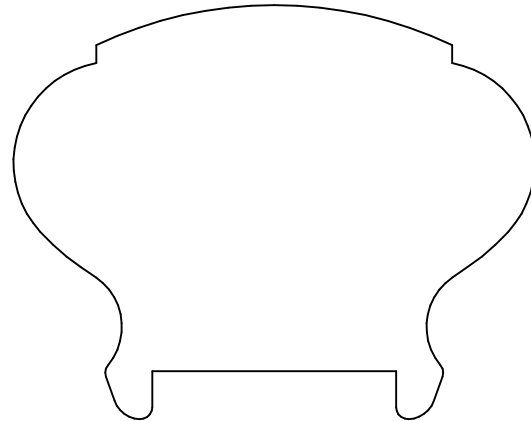

**KL 6916P**  
2.157 x 2.716

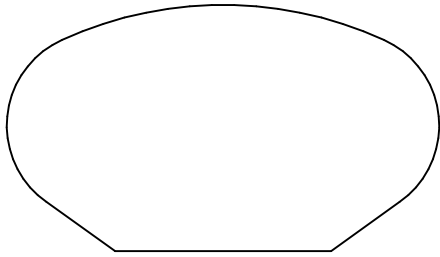

**KL 6917**  
1.281 x 2.250

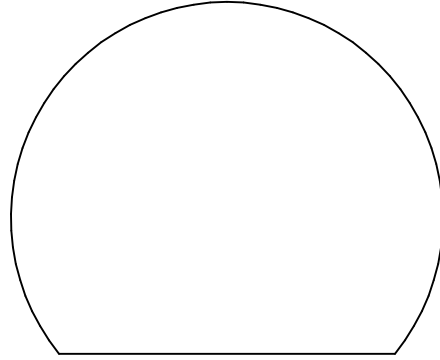

**KL 6918**  
1.832 x 2.250

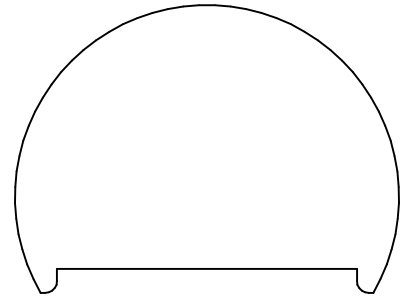

**KL 6923P**  
1.500 x 2.000

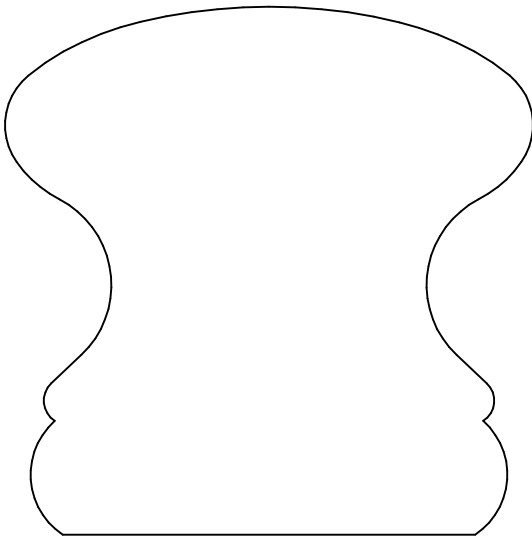

**KL 6919**  
2.750 x 2.750

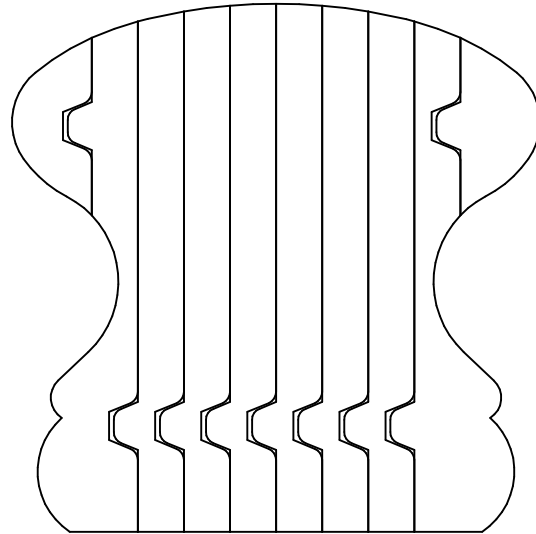

**KL 6919B**  
2.750 x 2.750

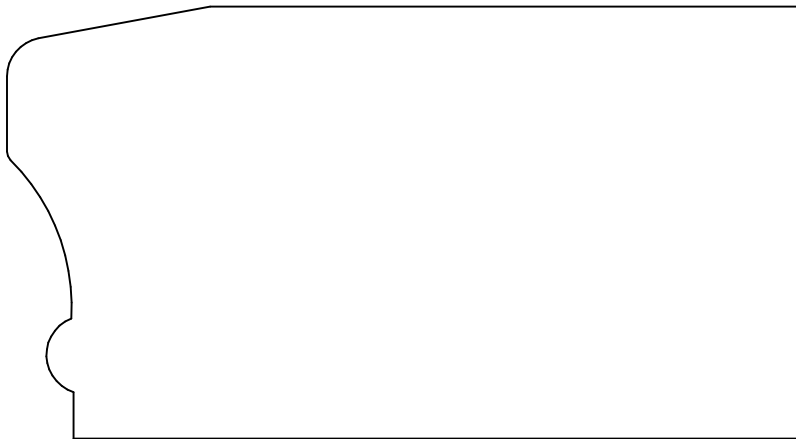

**KL 6921**  
2.250 x 4.125

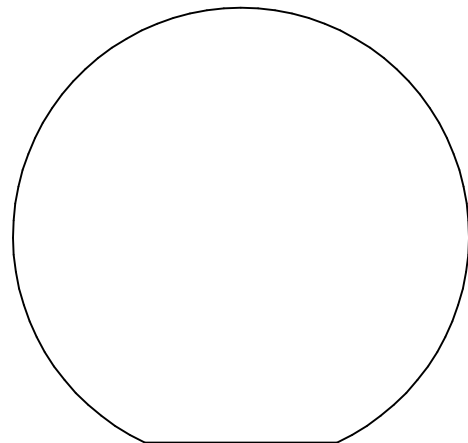

**KL 6922**  
2.265 x 2.375

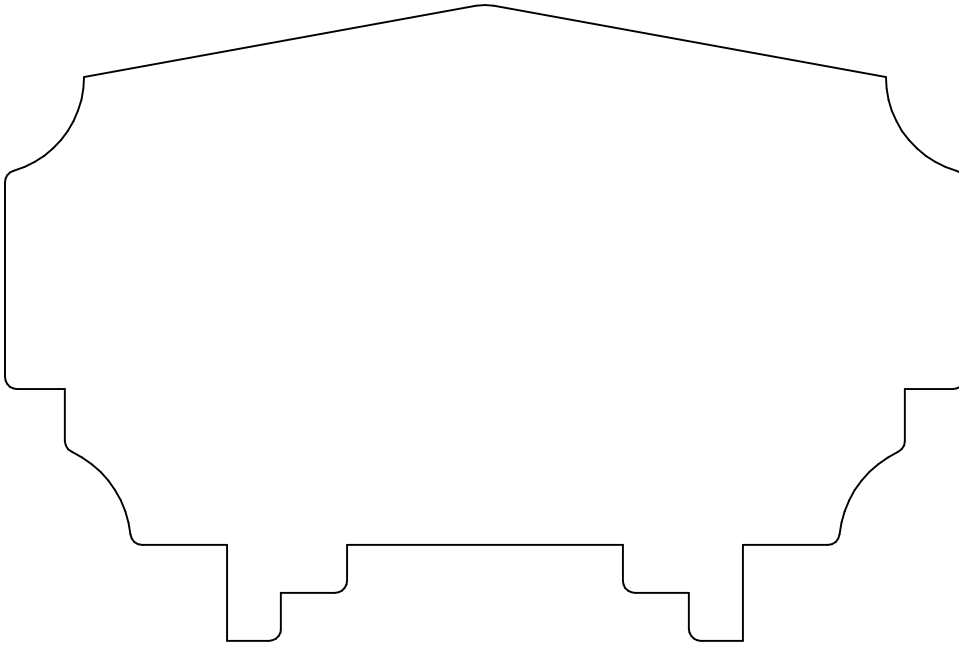

**KL 6924P**  
3.312 x 5.000

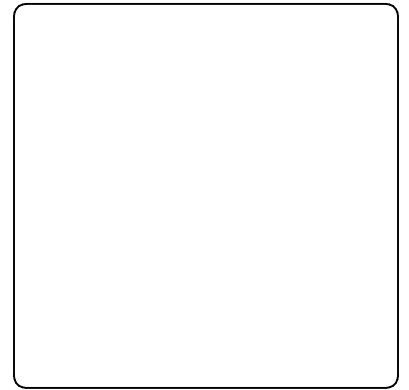

**KL 6930**  
2.000 x 2.000

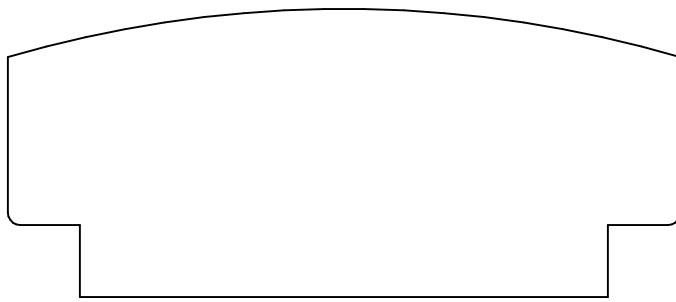

**KL 6925**  
1.500 x 3.500

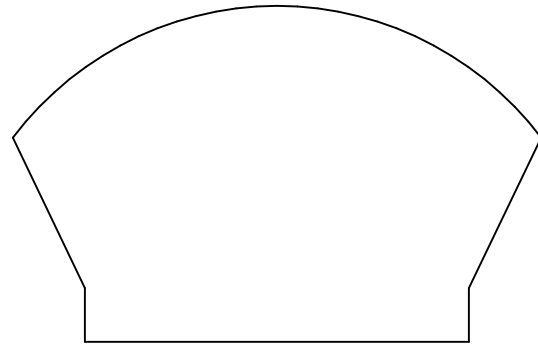

**KL 6926**  
1.750 x 2.750

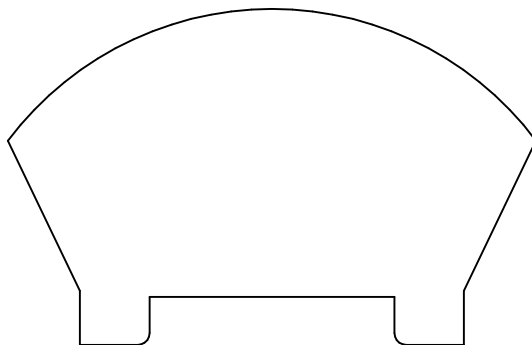

**KL 6926P**  
1.750 x 2.750

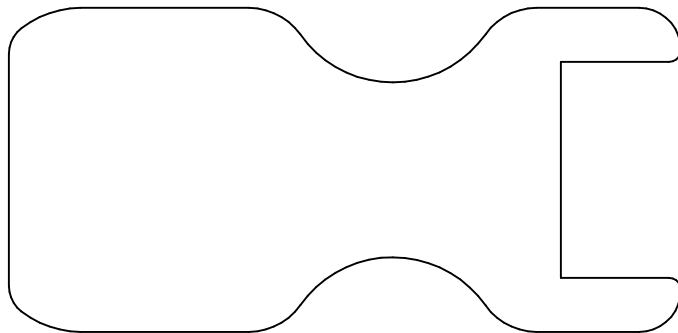

**KL 6927P**  
1.687 x 3.500

# CUSTOM PROFILES

# Handrail

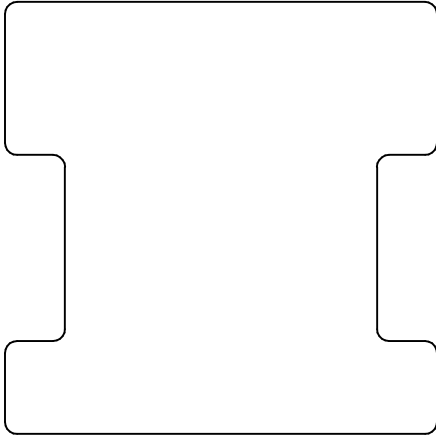

**KL 6928**  
2.250 x 2.250

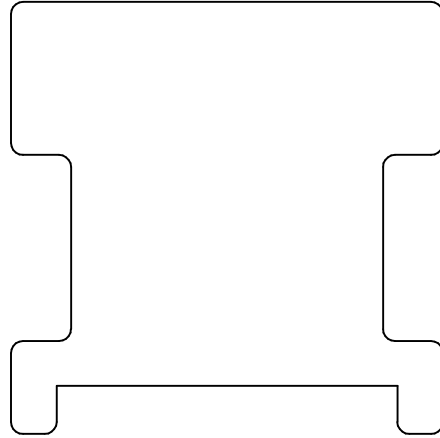

**KL 6928P**  
2.250 x 2.250

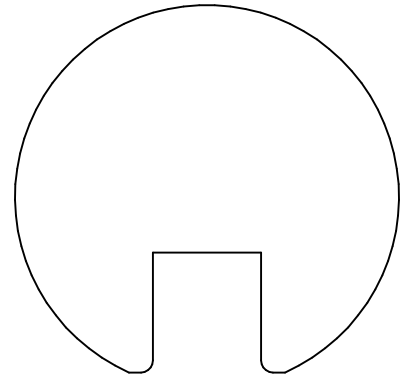

**KL 6946P**  
1.914 x 2.000

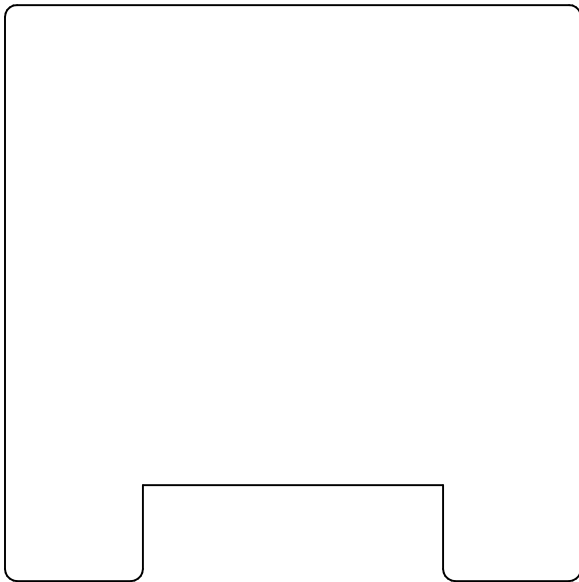

**KL 6929P**  
3.000 x 3.000

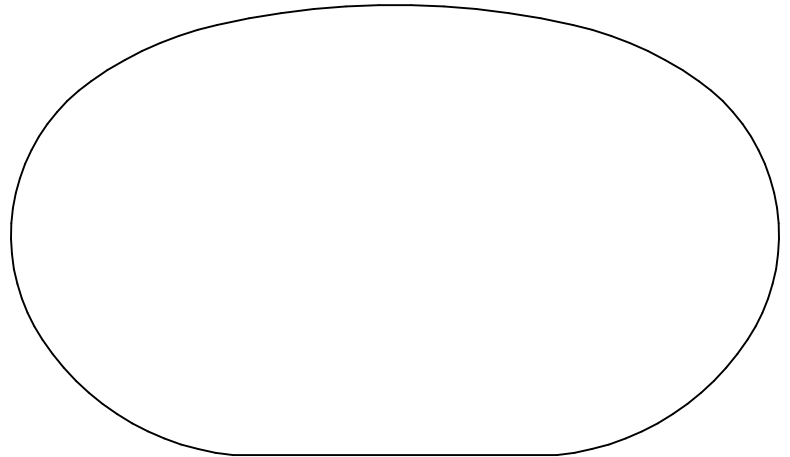

**KL 6931**  
2.344 x 4.000

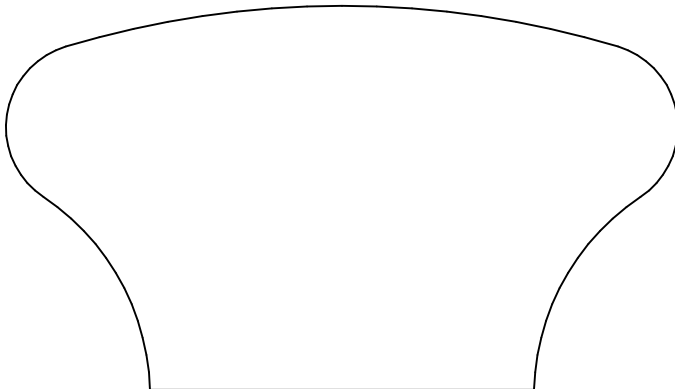

**KL 6932**  
2.000 x 3.500

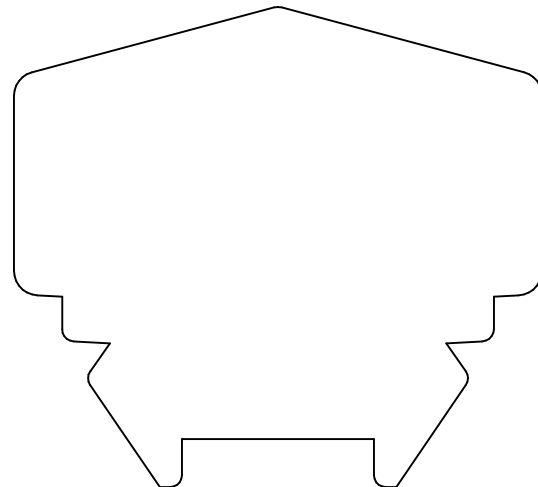

**KL 6933P**  
2.500 x 2.750

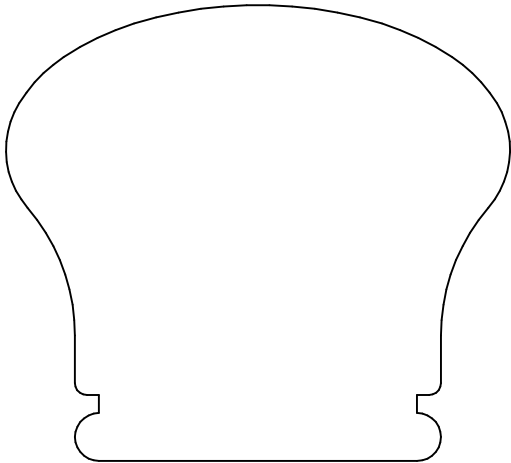

**KL 6934**  
2.375 x 2.625

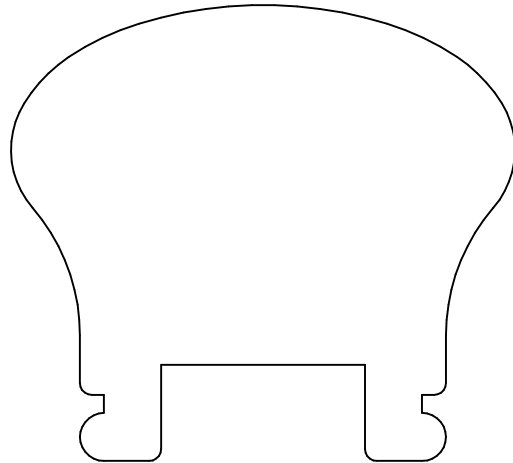

**KL 6934P**  
2.375 x 2.625

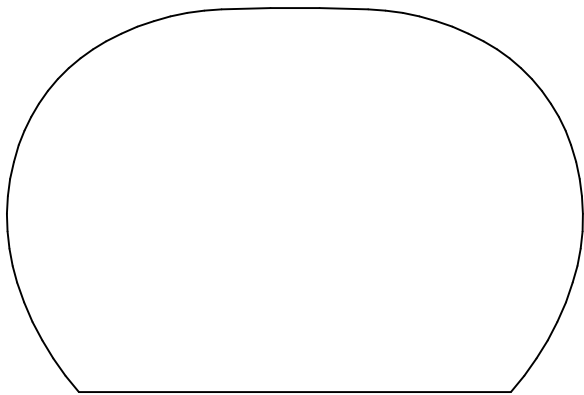

**KL 6935**  
2.000 x 3.000

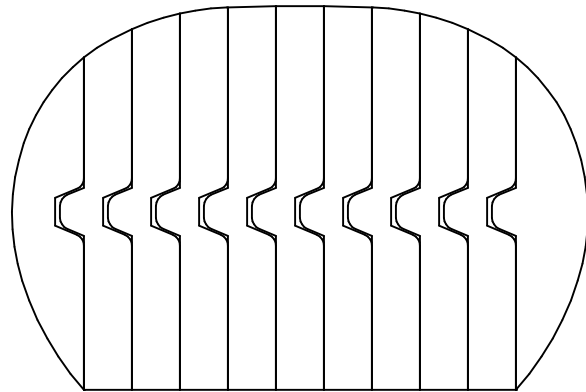

**KL 6935B**  
2.000 x 3.000

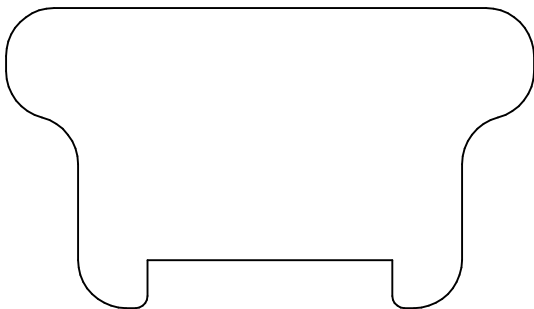

**KL 6936P**  
1.563 x 2.750

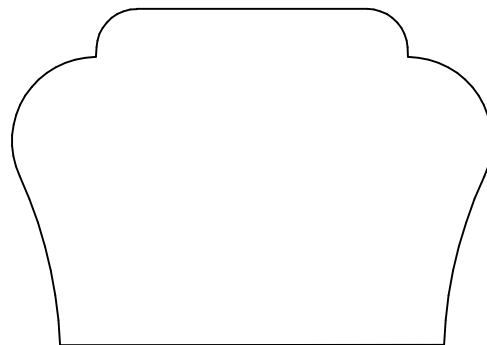

**KL 6937**  
1.750 x 2.500



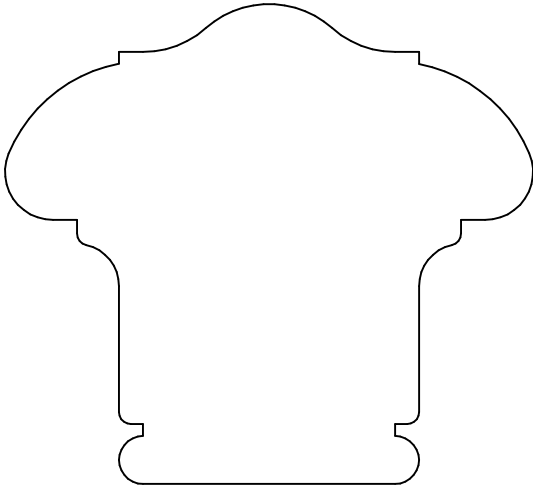

**KL 6938**  
2.500 x 2.750

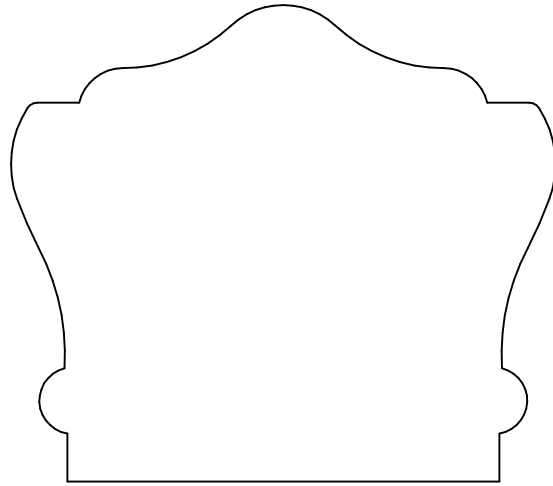

**KL 6939**  
2.482 x 2.836

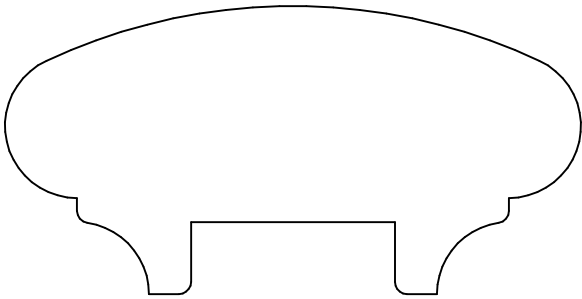

**KL 6940P**  
1.500 x 3.000



**KL 6941P**  
1.125 x 3.000

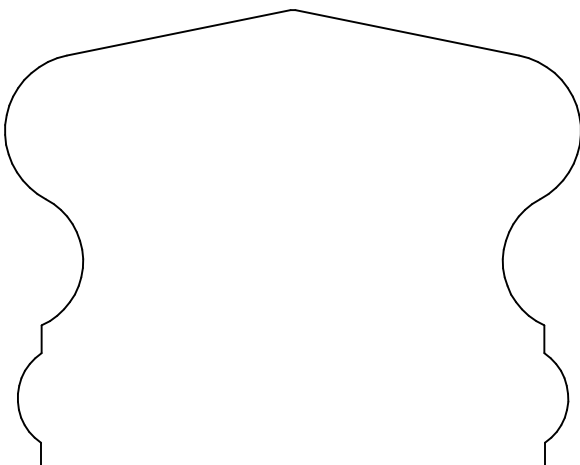

**KL 6942**  
2.375 x 3.000

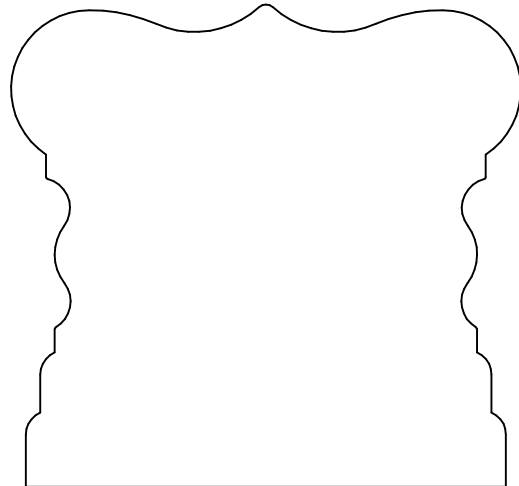

**KL 6943**  
2.512 x 2.656

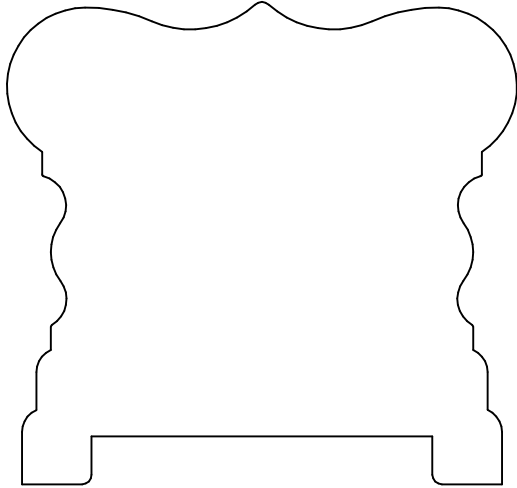

**KL 6943P**  
2.512 x 2.656

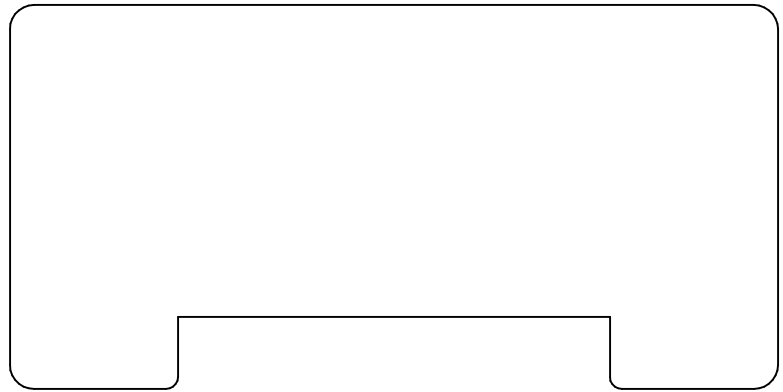

**KL 6944P**  
2.000 x 4.000

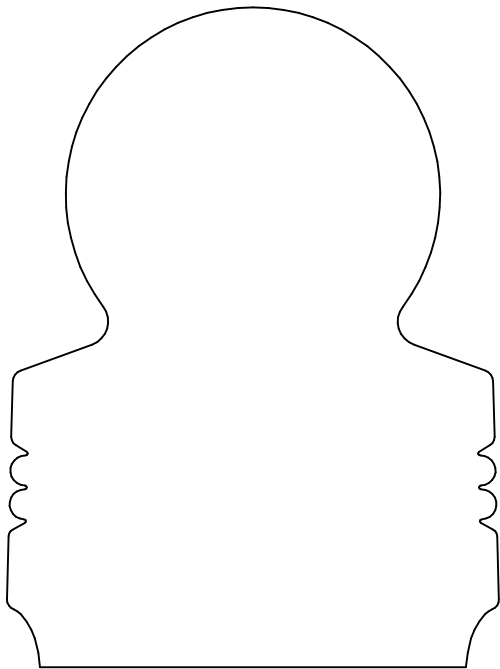

**KL 6945**  
3.438 x 2.562

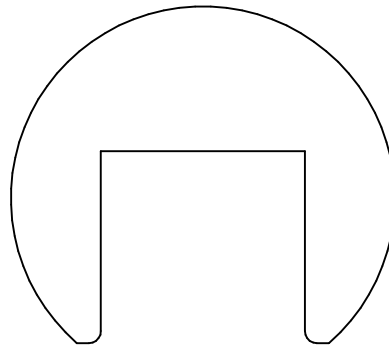

**KL 6947P**  
1.754 x 2.000

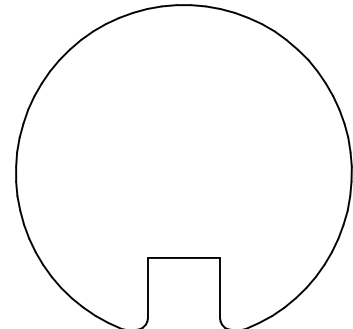

**KL 6953P**  
1.692 x 1.750

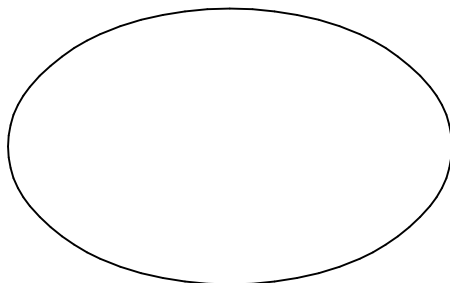

**KL 6956**  
1.438 x 2.312

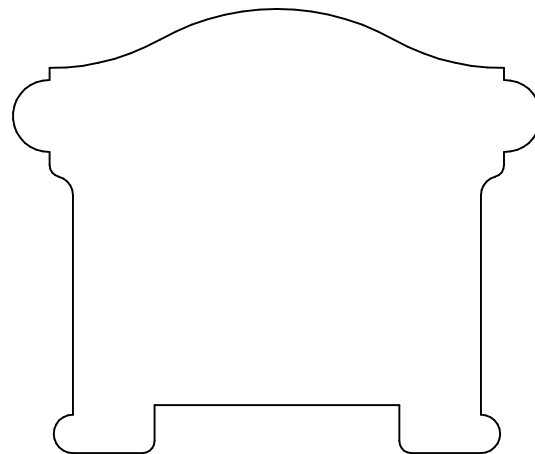

**KL 6951P**  
2.312 x 2.750

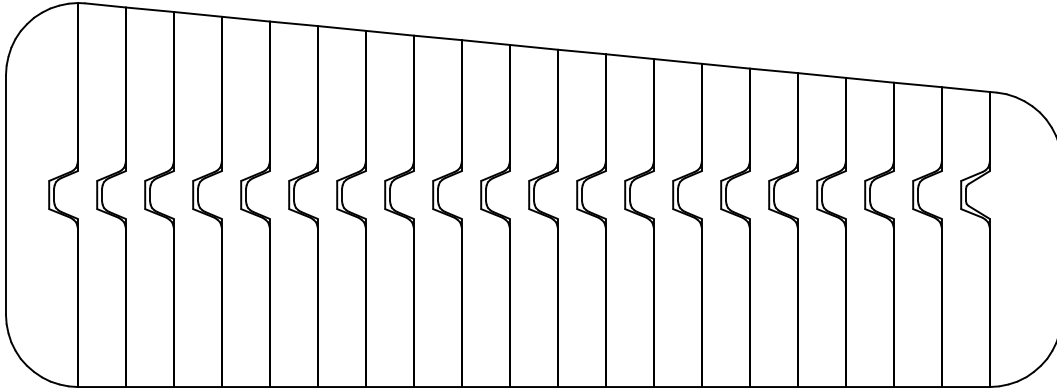

**KL 6949B**  
2.000 x 5.500

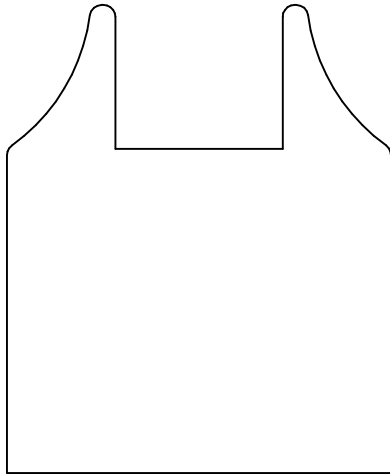

**KL 6952-2**  
2.439 x 2.000

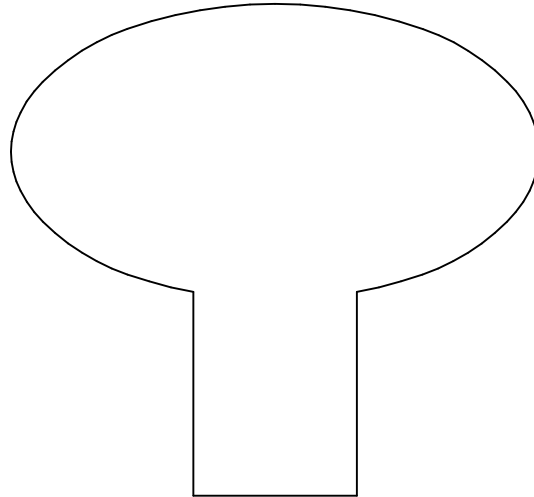

**KL 6952-1**  
2.561 x 2.750

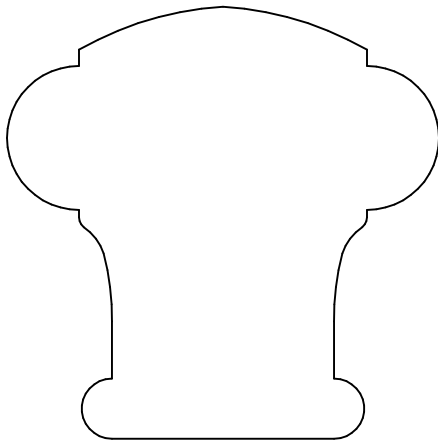

**KL 6955**  
2.250 x 2.250

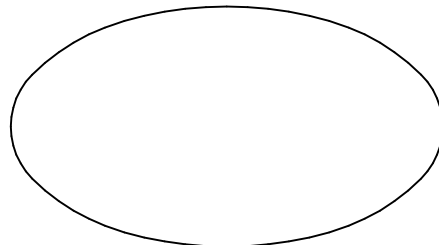

**KL 6957**  
1.250 x 2.250

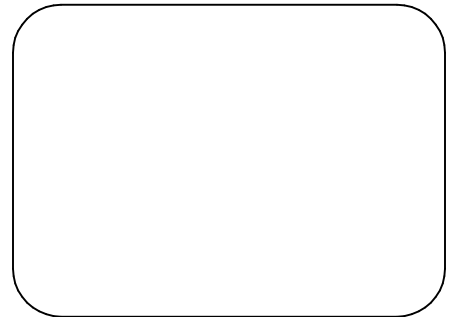

**KL 6961**  
1.625 x 2.250

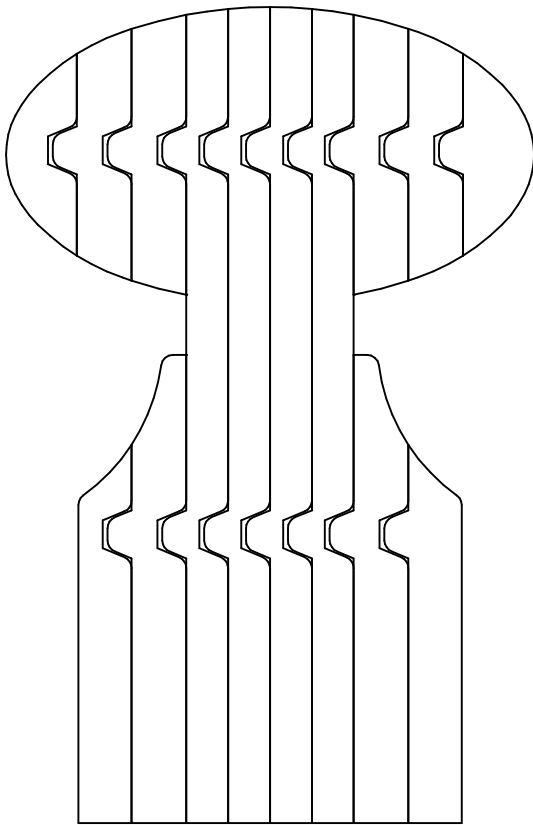

**KL 6952B**  
2.750 x 4.250

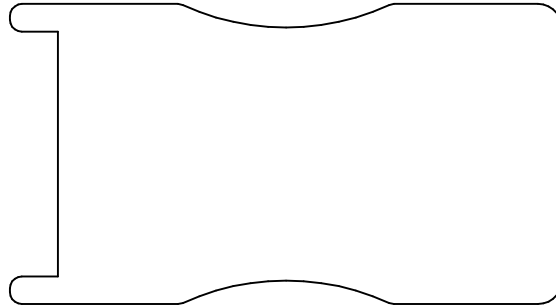

**KL 6954P**  
1.563 x 2.875

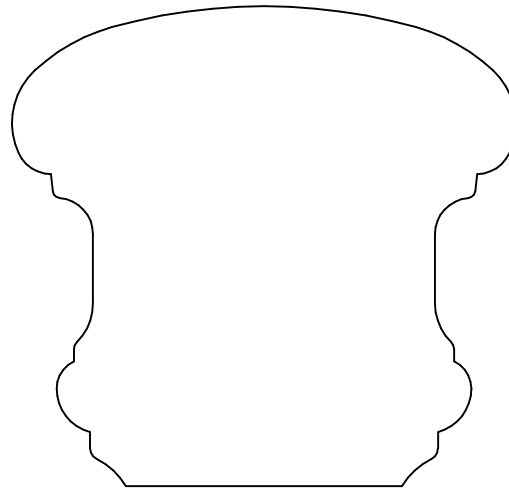

**KL 6958**  
2.500 x 2.625

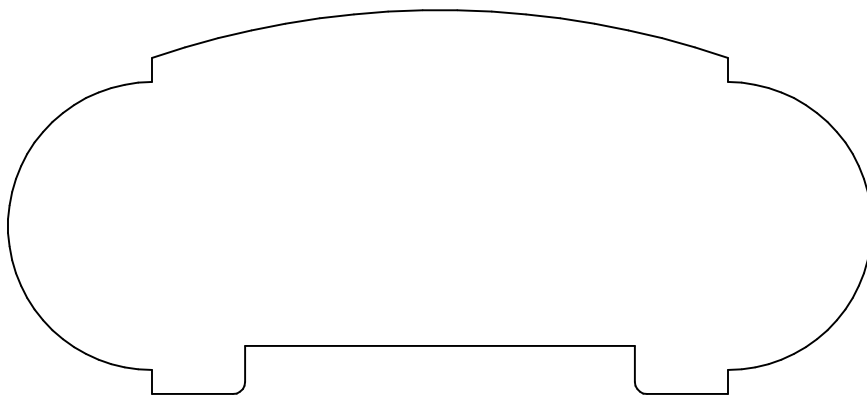

**KL 6959P**  
2.000 x 4.500

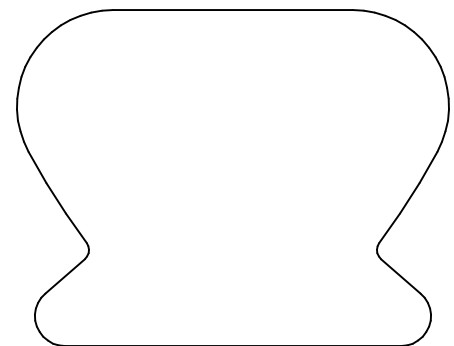

**KL 6963**  
1.750 x 2.250

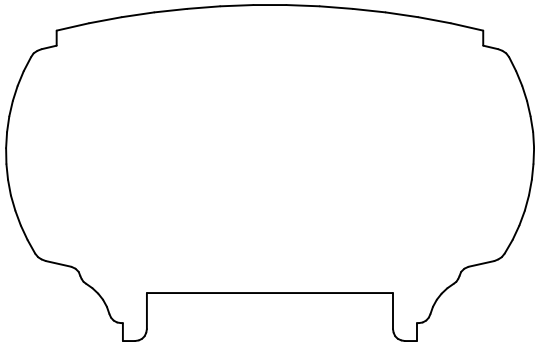

**KL 6960P**  
1.750 x 2.750

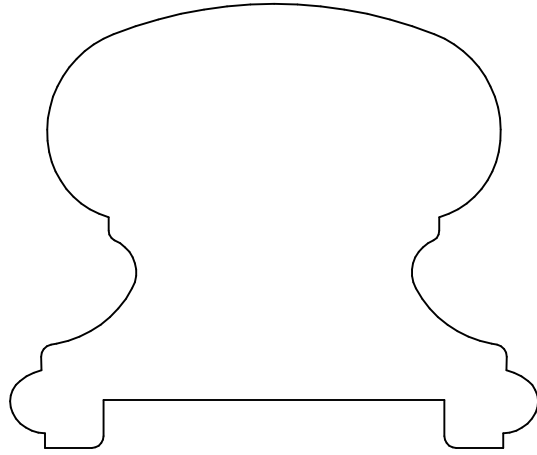

**KL 6964P**  
2.312 x 2.750

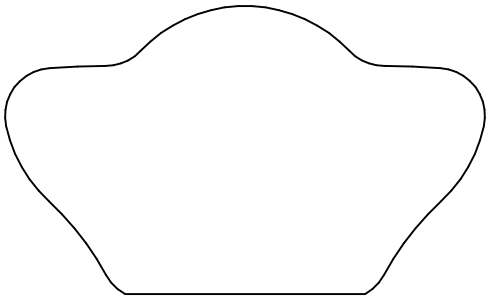

**KL 6965**  
1.500 x 2.500



**KL 6966P**  
1.375 x 3.188

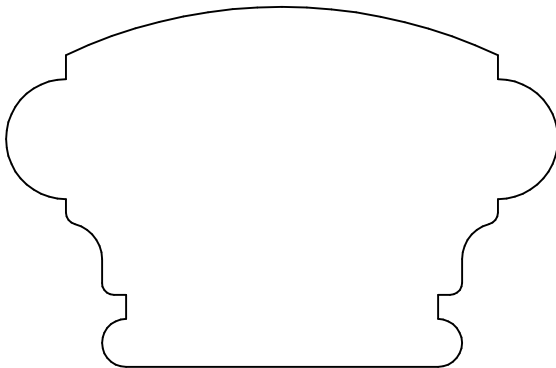

**KL 6967**  
1.875 x 2.875

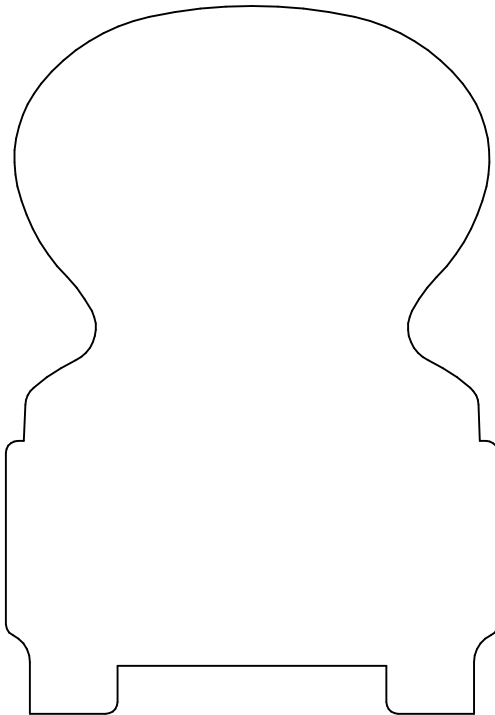

**KL 6968P**  
3.687 x 2.562

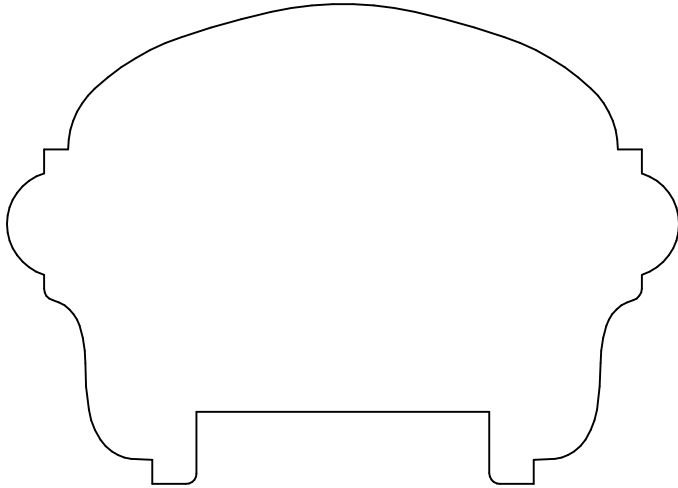

**KL 6969P**  
2.500 x 3.500

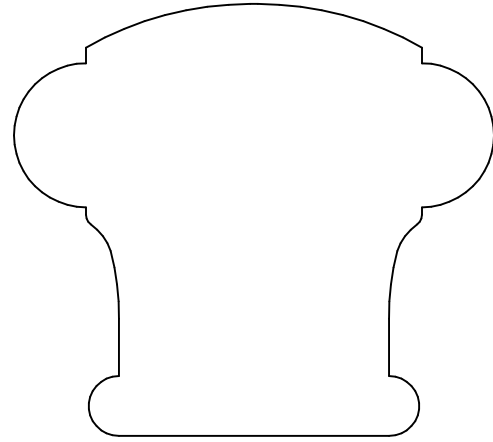

**KL 6970**  
2.250 x 2.500

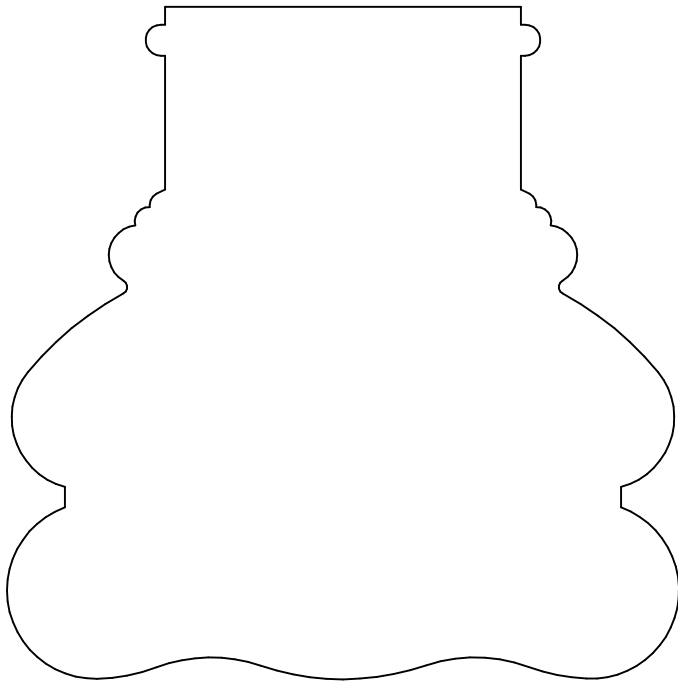

**KL 6971**  
3.500 x 3.500

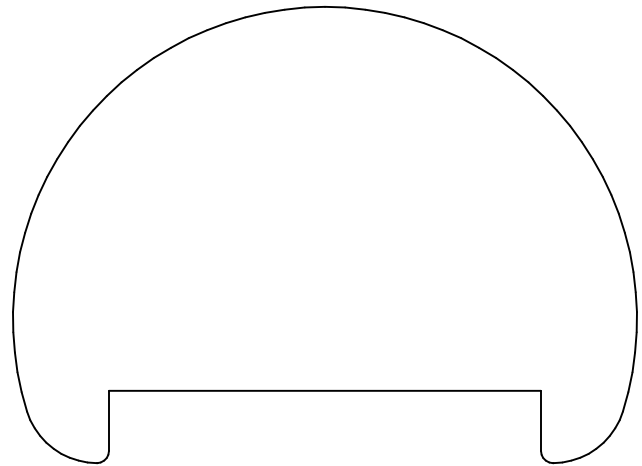

**KL 6973P**  
2.375 x 3.250

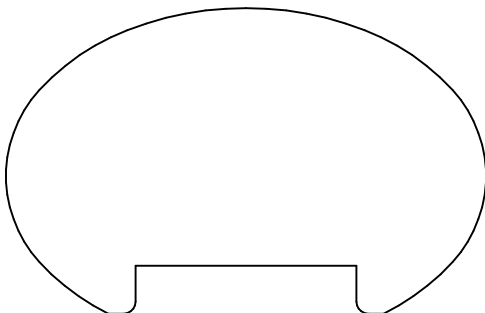

**KL 6979P**  
1.592 x 2.500

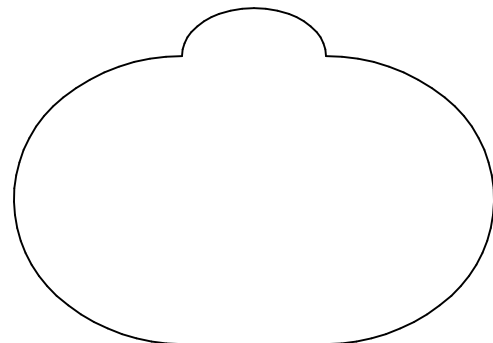

**KL 6974**  
1.750 x 2.500

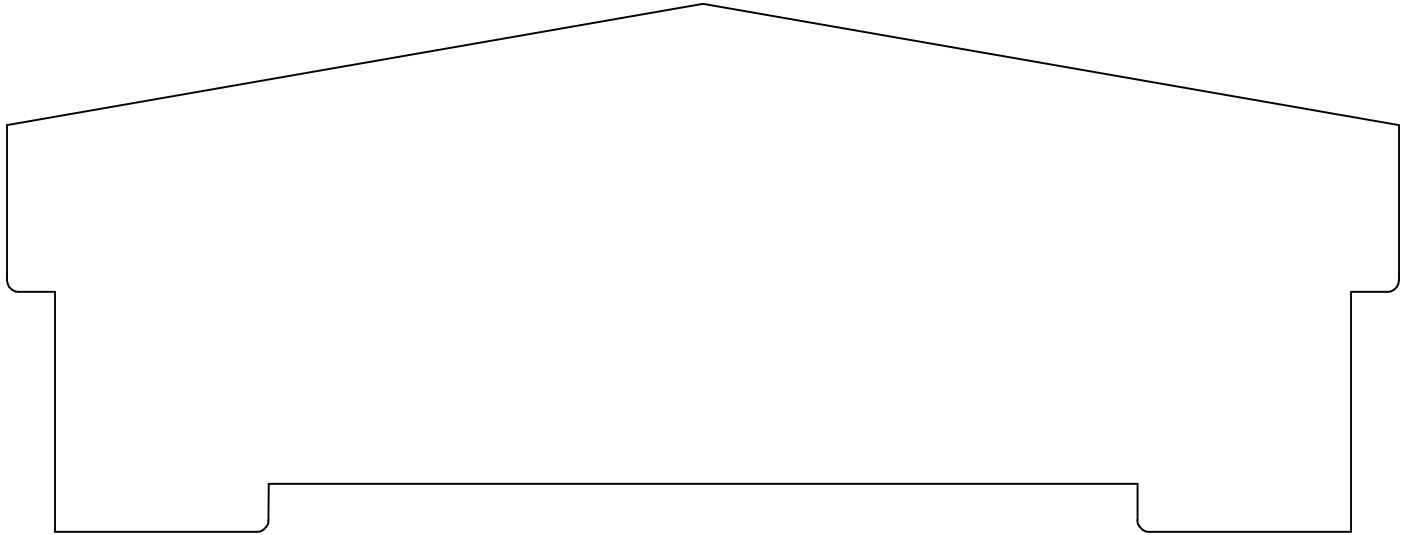

**KL 6972P**  
2.750 x 7.250

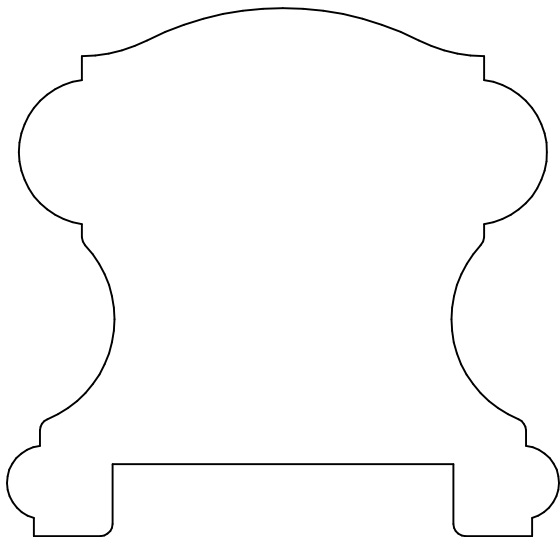

**KL 6975P**  
2.750 x 2.875

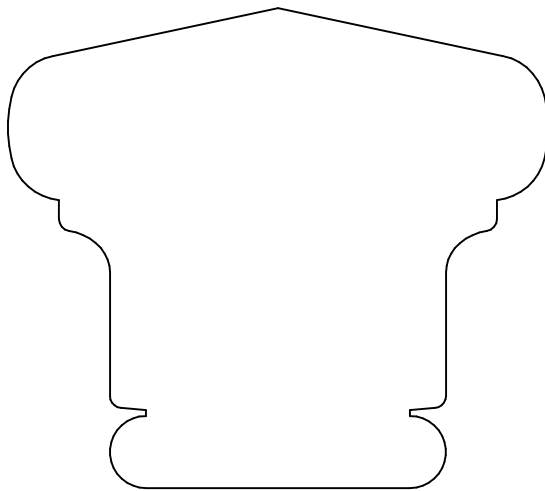

**KL 6976**  
2.500 x 2.813



**KL 6994**  
.313 x .937

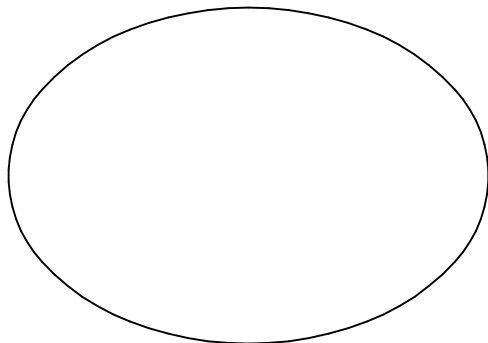

**KL 6979**  
1.750 x 2.500

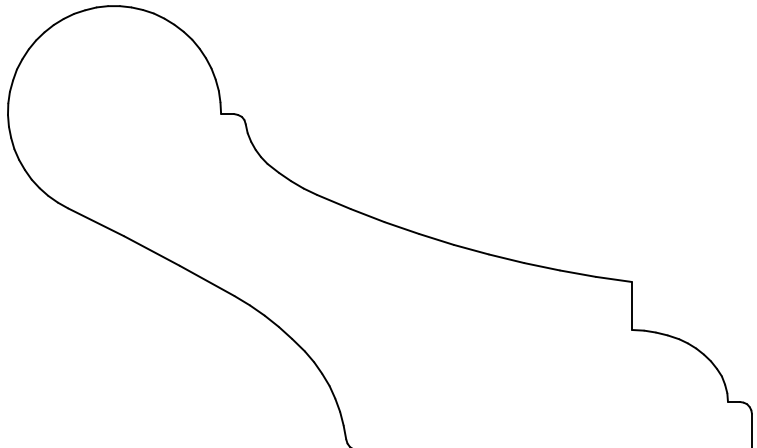

**KL 6977**  
2.312 x 3.875

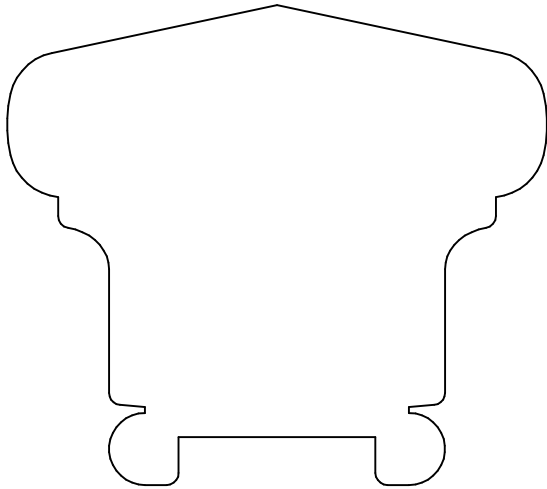

**KL 6976P**  
2.500 x 2.813

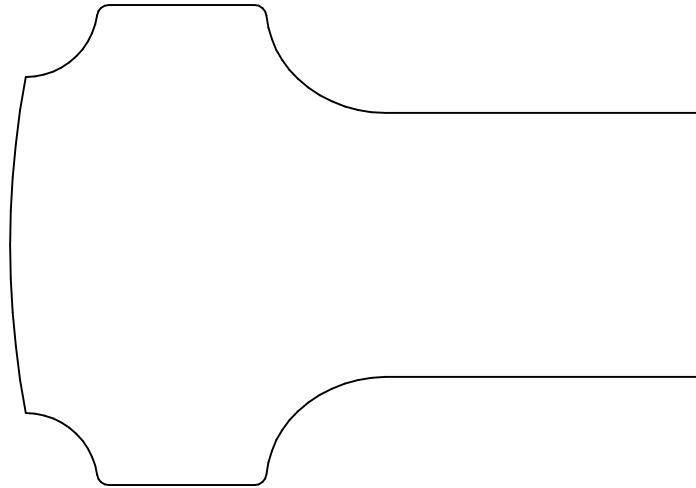

**KL 6978**  
3.594 x 2.500

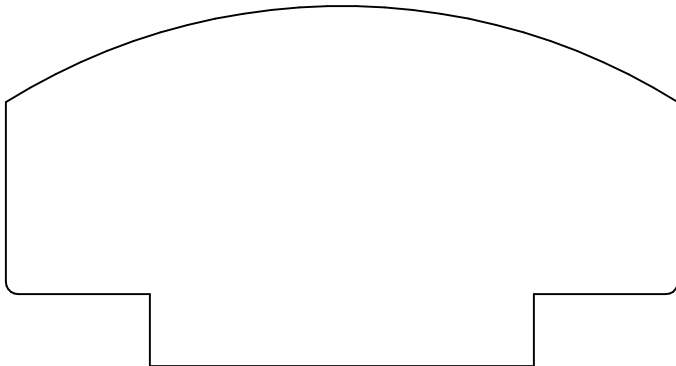

**KL 6980**  
1.875 x 3.500

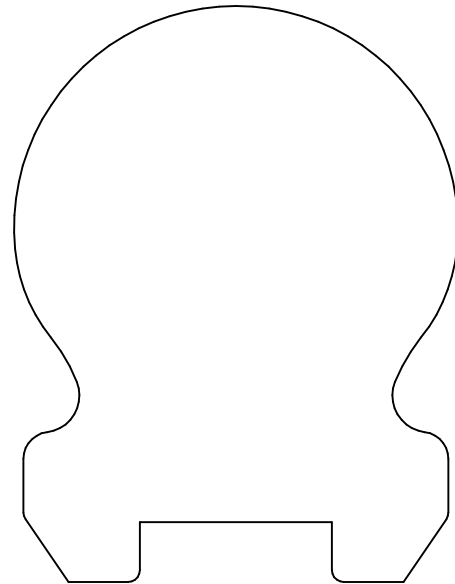

**KL 6981P**  
3.000 x 2.312

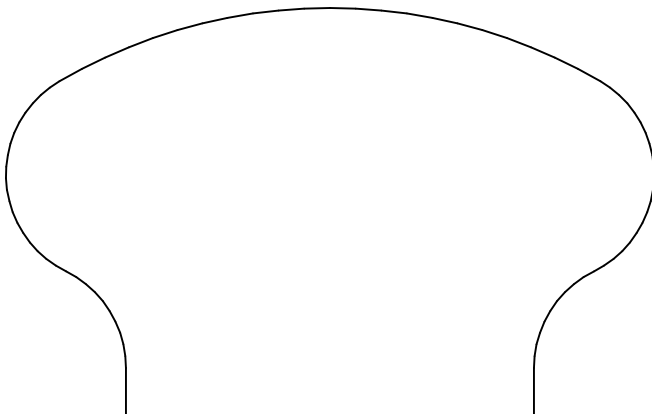

**KL 6983**  
2.125 x 3.375

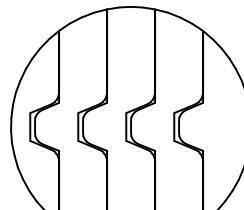

**KL 6986B**  
1.062 x 1.250

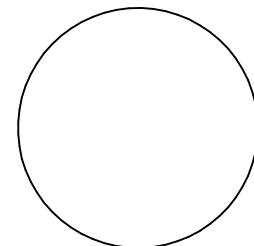

**KL 6987**  
1.250 x 1.250



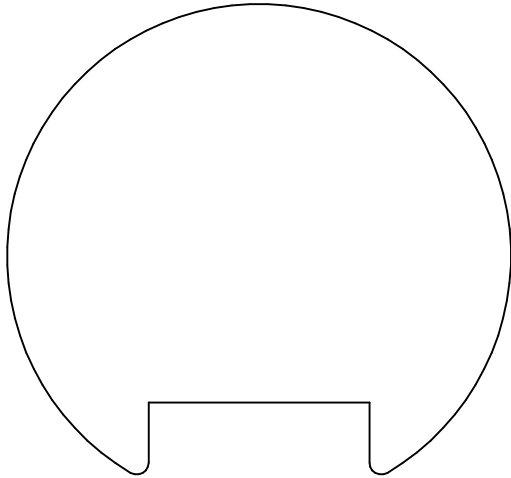

**KL 6982P**  
2.451 x 2.625

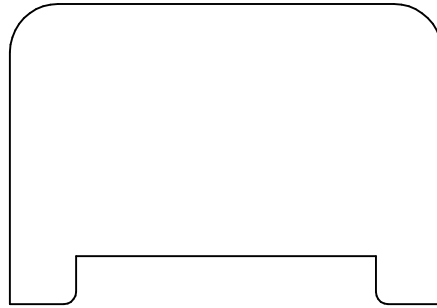

**KL 6984P**  
1.563 x 2.250

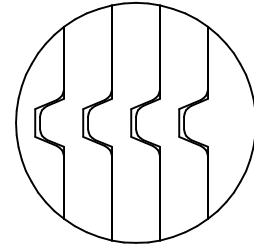

**KL 6987B**  
1.250 x 1.250

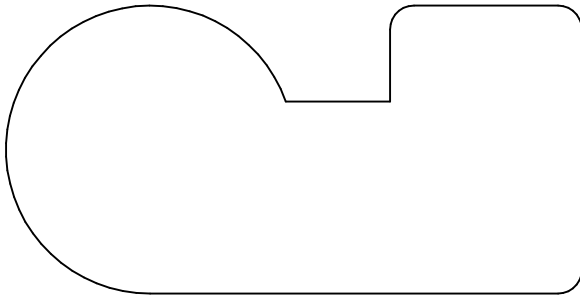

**KL 6985**  
1.500 x 3.000

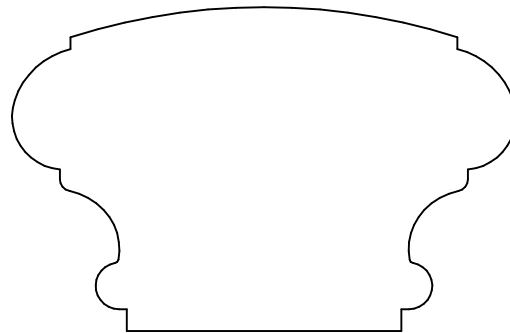

**KL 6988**  
1.687 x 2.625



**KL 6989**  
1.562 x 2.250

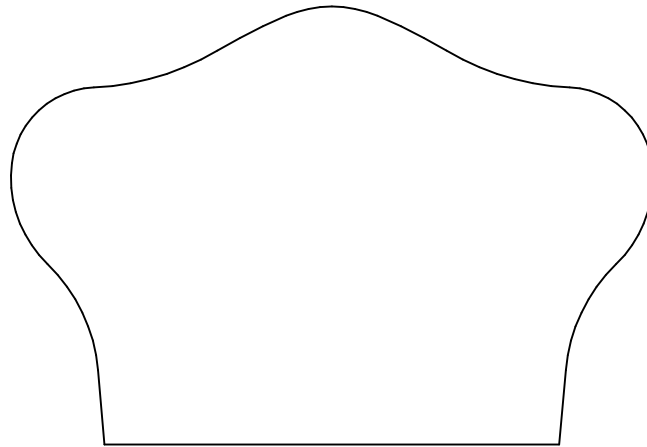

**KL 6990**  
2.281 x 3.343

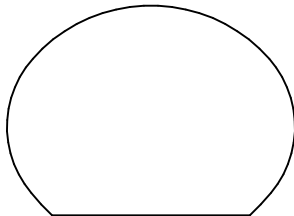

**KL 6996**  
1.093 x 1.500

# CUSTOM PROFILES

# Handrail

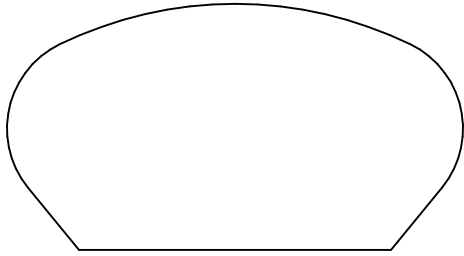

**KL 6991**  
1.281 x 2.375

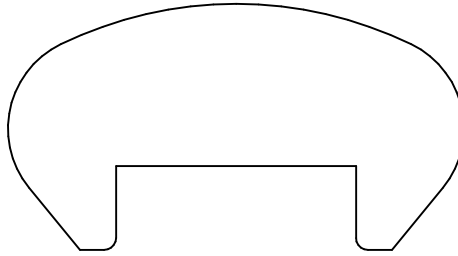

**KL 6991P**  
1.281 x 2.375



**KL 6998P**  
1.000 x 2.000

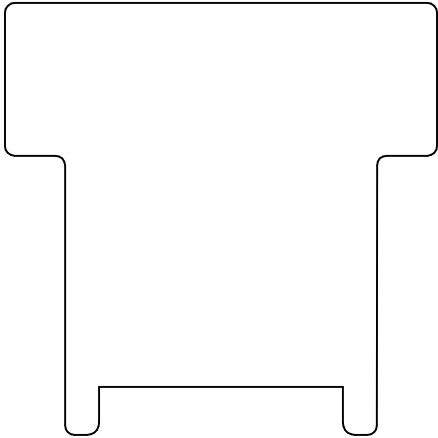

**KL 6992P**  
2.250 x 2.250

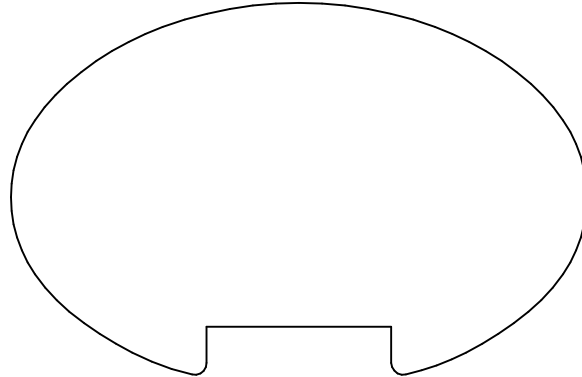

**KL 6993P**  
1.937 x 3.000

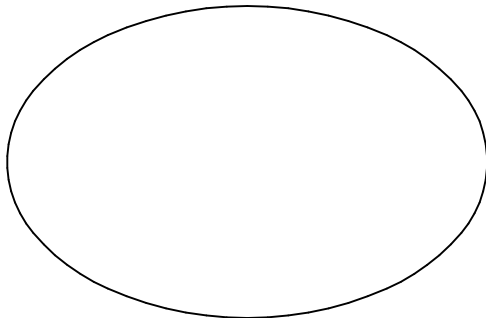

**KL 6995**  
1.625 x 2.500

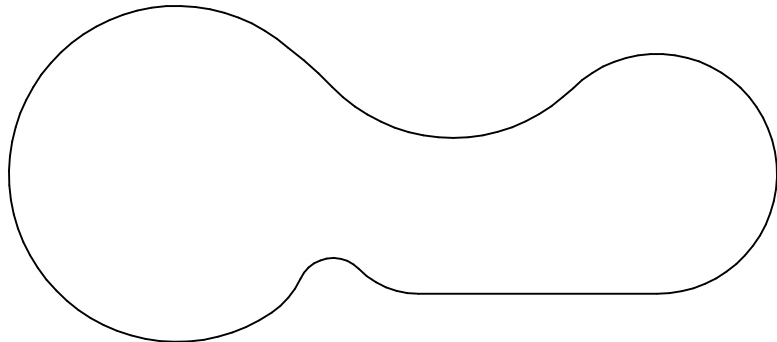

**KL 6997**  
1.750 x 4.000



**KL 6999P**  
1.500 x 4.000

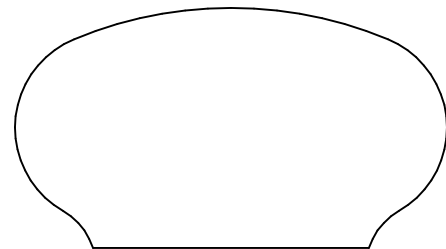

**KL 7900**  
1.250 x 2.250

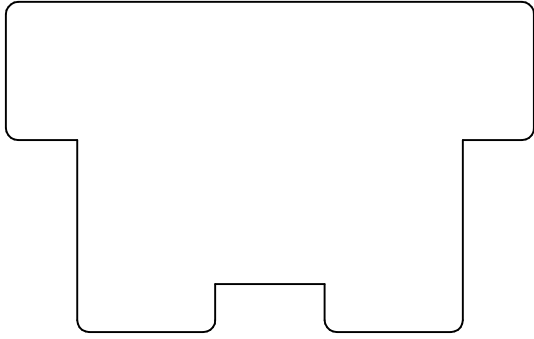

**KL 7901P**  
1.719 x 2.750

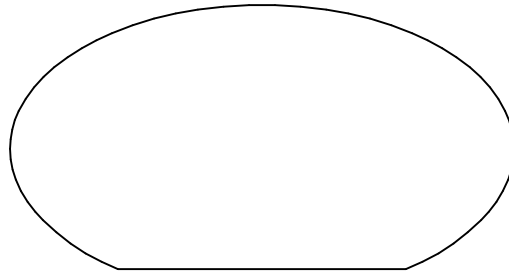

**KL 7902**  
1.375 x 2.625

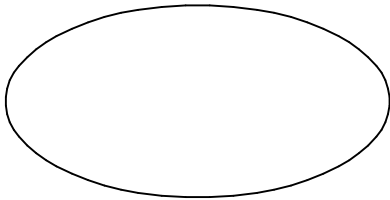

**KL 7903**  
1.000 x 2.000

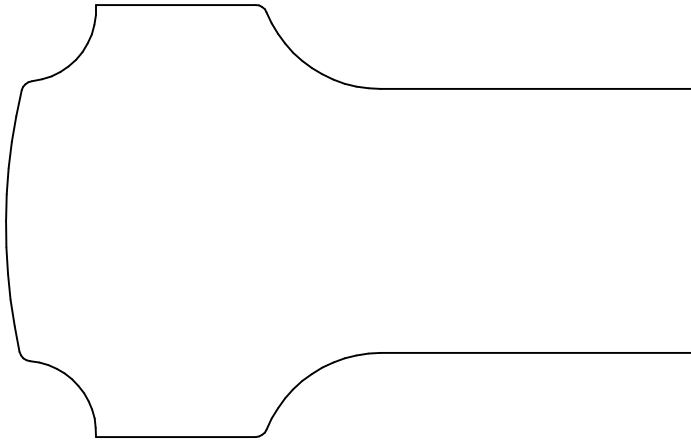

**KL 7904**  
2.250 x 3.593

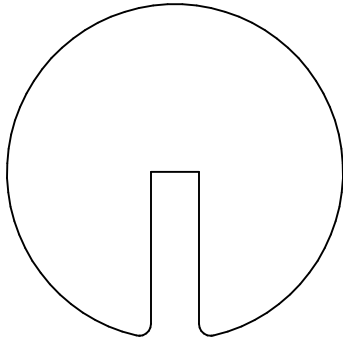

**KL 7905P**  
1.728 x 1.750

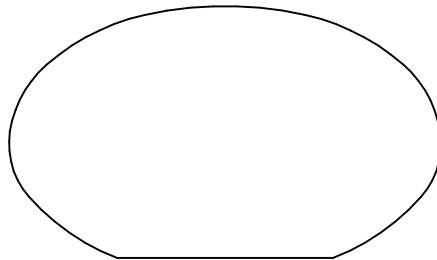

**KL 7906**  
1.312 x 2.250

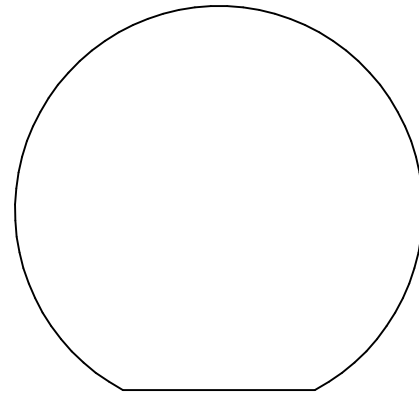

**KL 7908**  
2.000 x 2.125

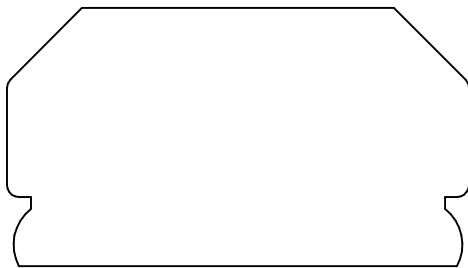

**KL 7910**  
1.344 x 2.406



**KL 7911**  
.781 x 2.438



**KL 7926**  
.625 x 1.500

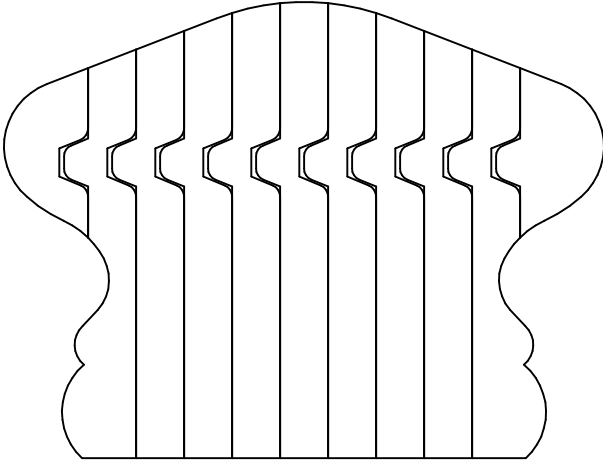

**KL 7907B**  
2.375 x 3.125

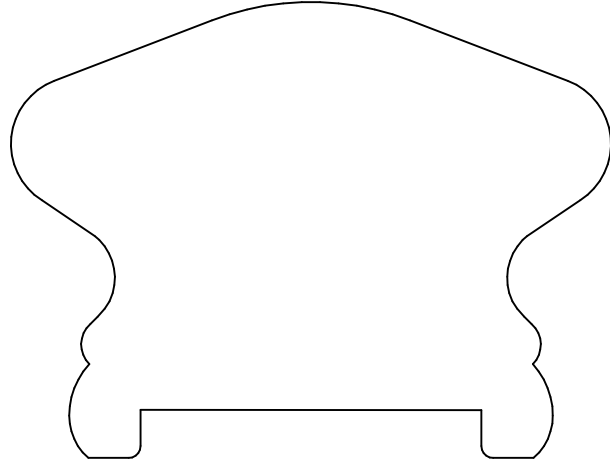

**KL 7907P**  
2.375 x 3.125

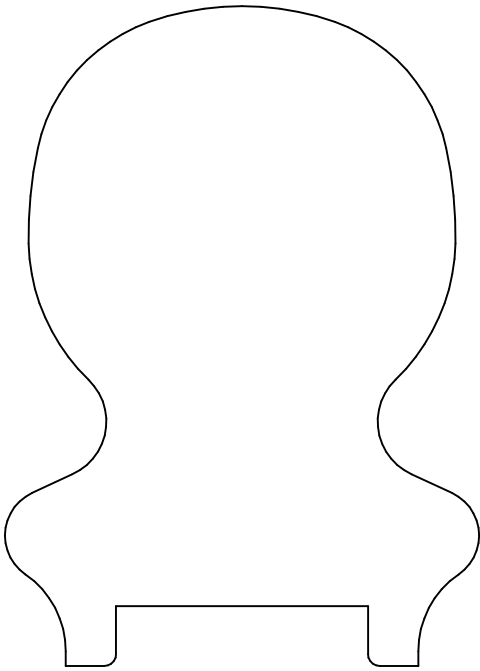

**KL 7909P**  
3.438 x 2.469

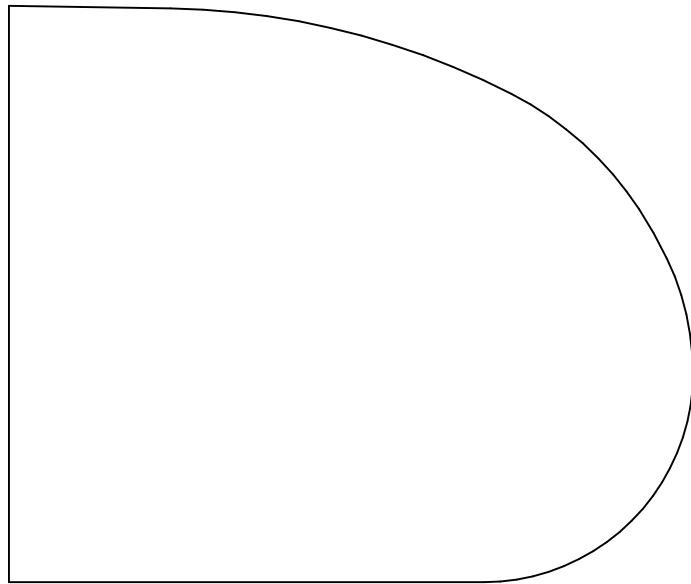

**KL 7912**  
3.000 x 3.562

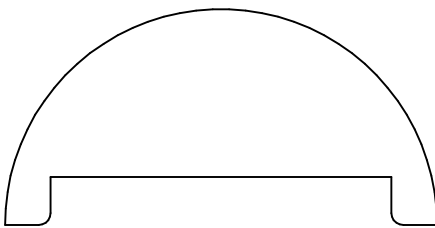

**KL 7914P**  
1.125 x 2.250

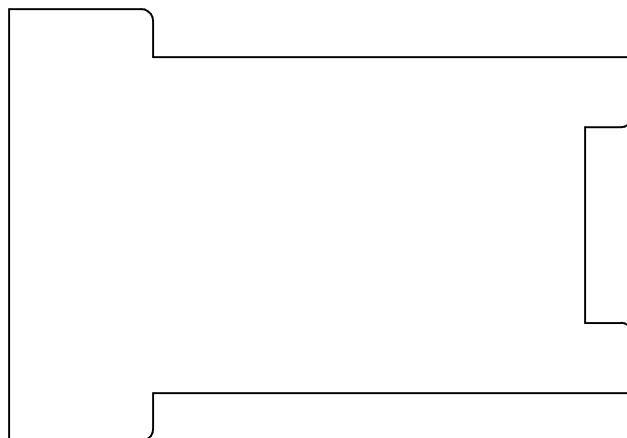

**KL 7913P**  
2.250 x 3.250

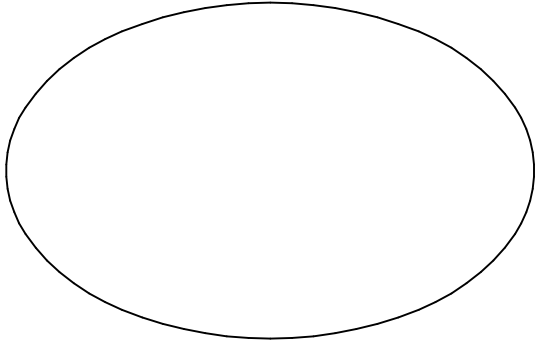

**KL7915**  
1.750 x 2.750

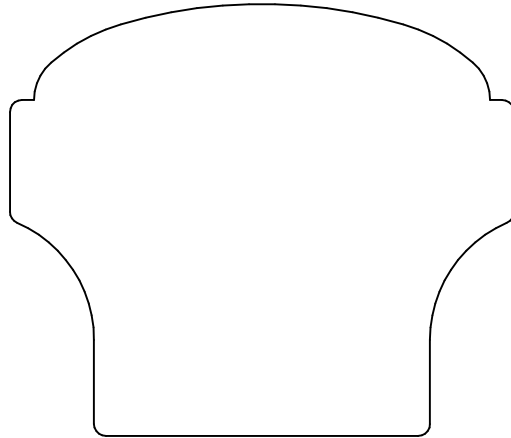

**KL 7916**  
2.250 x 2.625

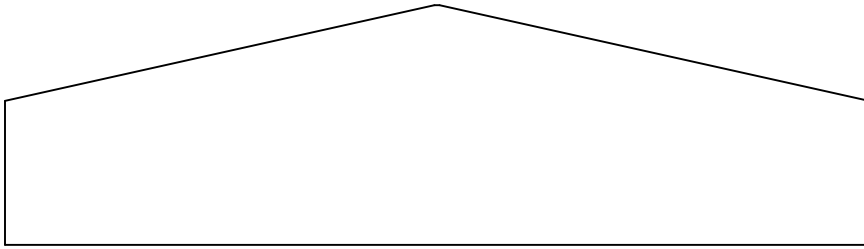

**KL 7917**  
1.250 x 4.500

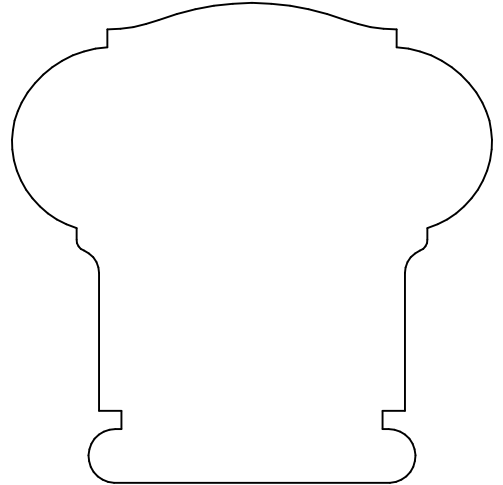

**KL 7920**  
2.500 x 2.500

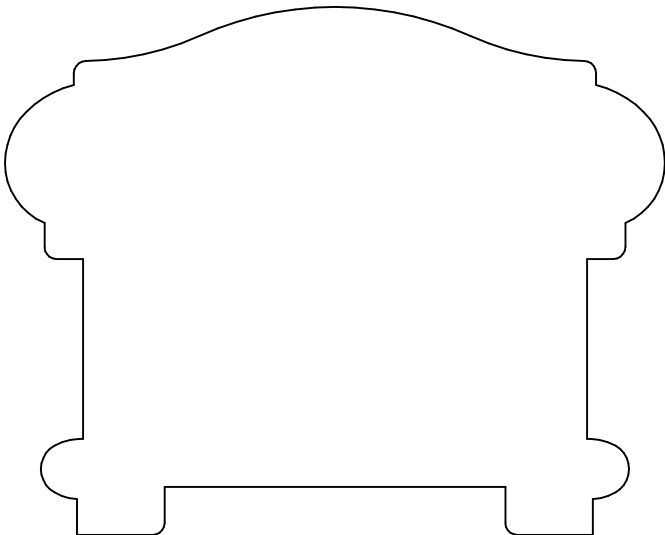

**KL 7918P**  
2.750 x 3.437

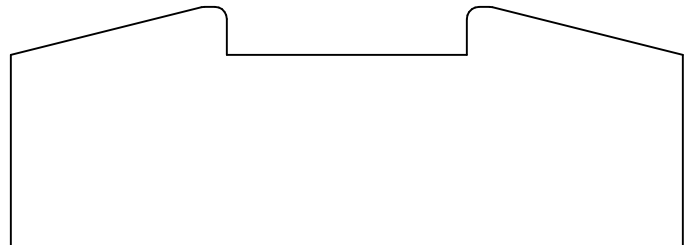

**KL 7921P**  
1.250 x 3.500

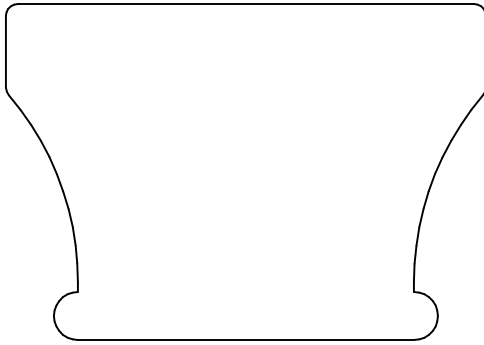

**KL 7922**  
1.750 x 2.500

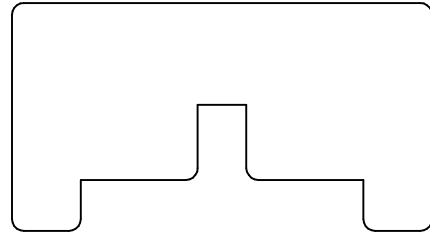

**KL 7923P**  
1.187 x 2.188

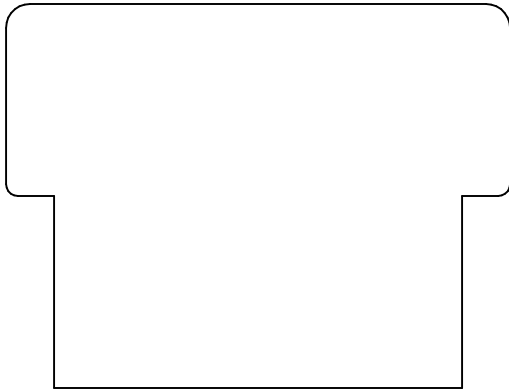

**KL 7924**  
2.000 x 2.625

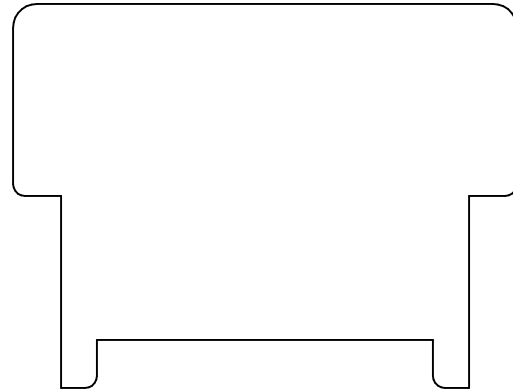

**KL 7924P**  
2.000 x 2.625

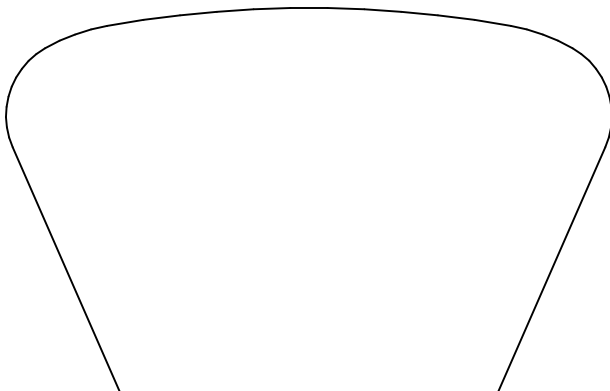

**KL 7927**  
2.000 x 3.156

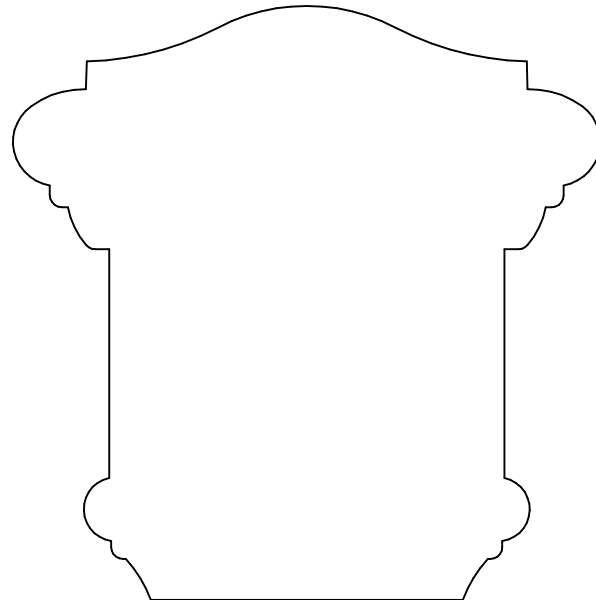

**KL 7928**  
3.094 x 3.059

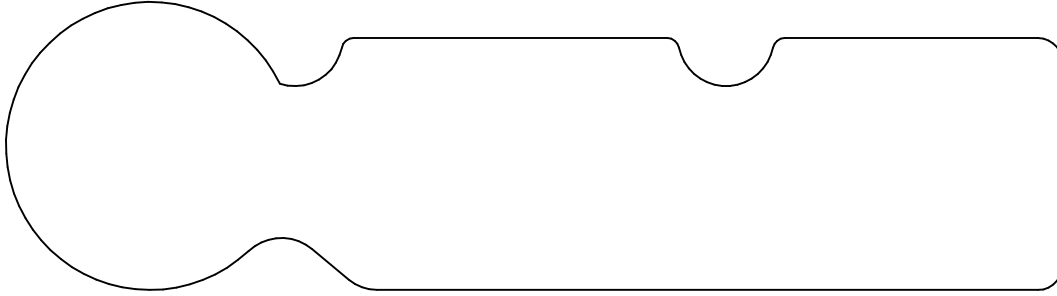

**KL 7929**  
1.500 x 5.500

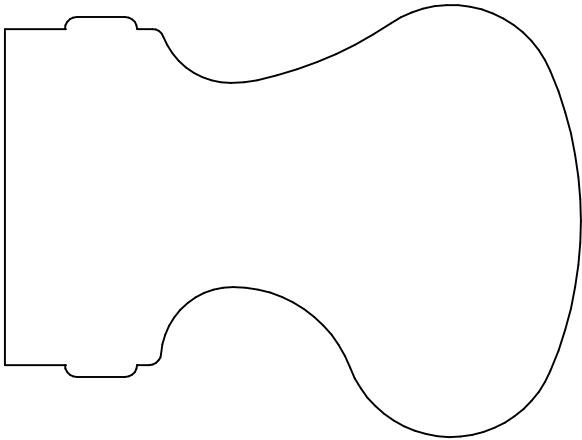

**KL 7930**  
3.000 x 2.250

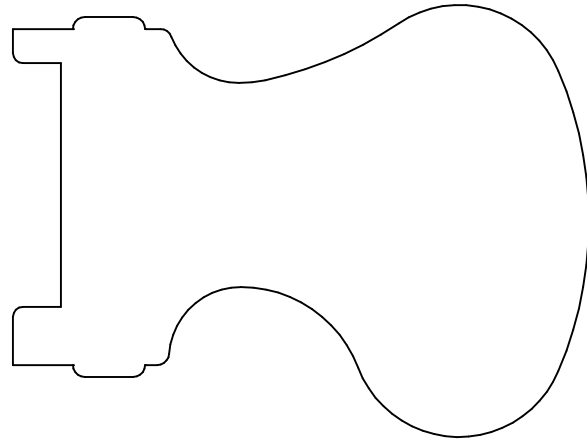

**KL 7930P**  
3.000 x 2.250

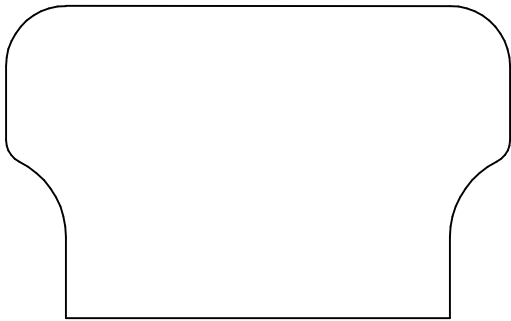

**KL 7931**  
1.625 x 2.625

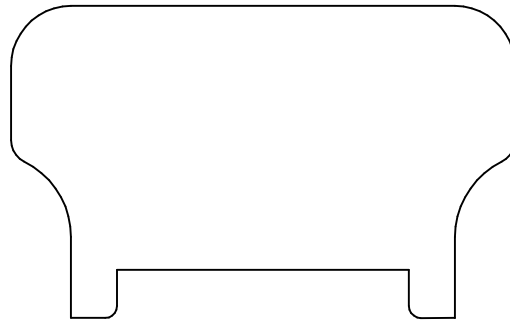

**KL 7931P**  
1.625 x 2.625

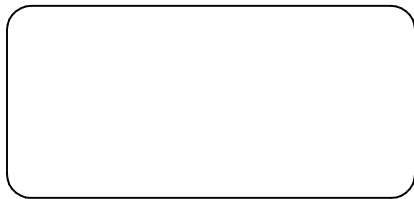

**KL 7942**  
1.000 x 2.125



**KL 7942P**  
1.000 x 2.125

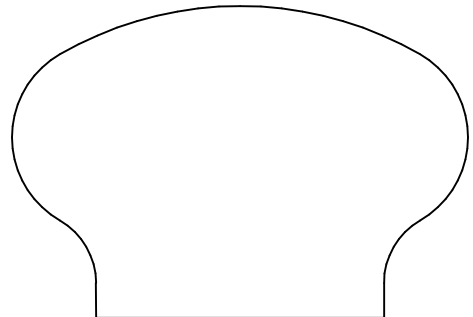

**KL 7944**  
1.625 x 2.375

# CUSTOM PROFILES

# Handrail

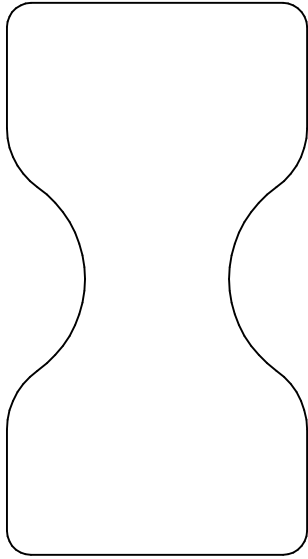

**KL 7932**  
1.562 x 2.875

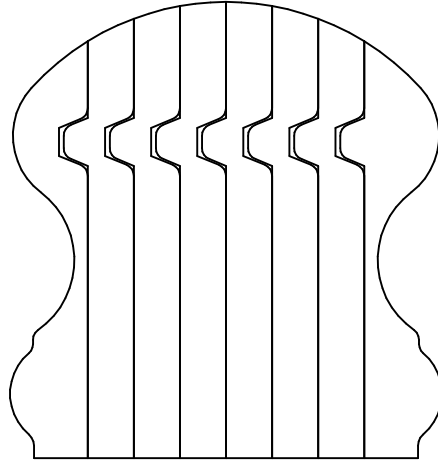

**KL 7933BR**  
2.375 x 2.250

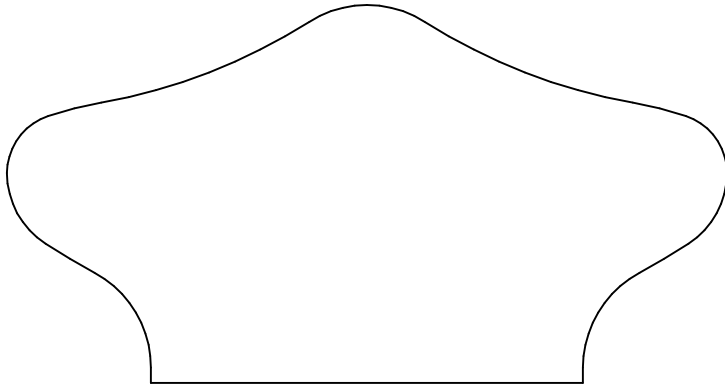

**KL 7933**  
1.969 x 3.750

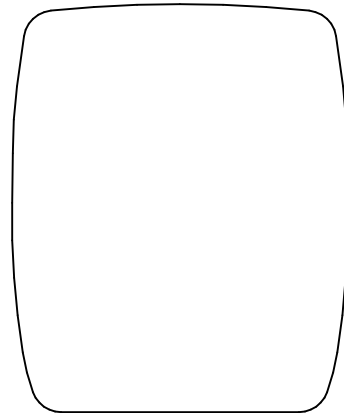

**KL 7934**  
2.125 x 1.750

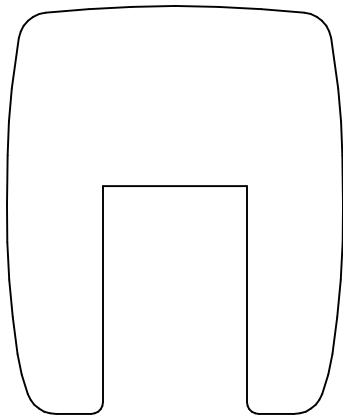

**KL 7934P**  
2.125 x 1.750

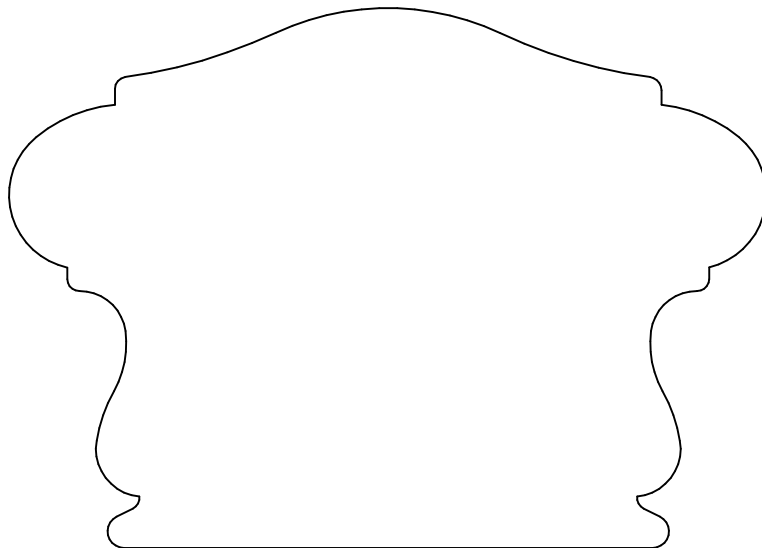

**KL 7935**  
2.812 x 3.944



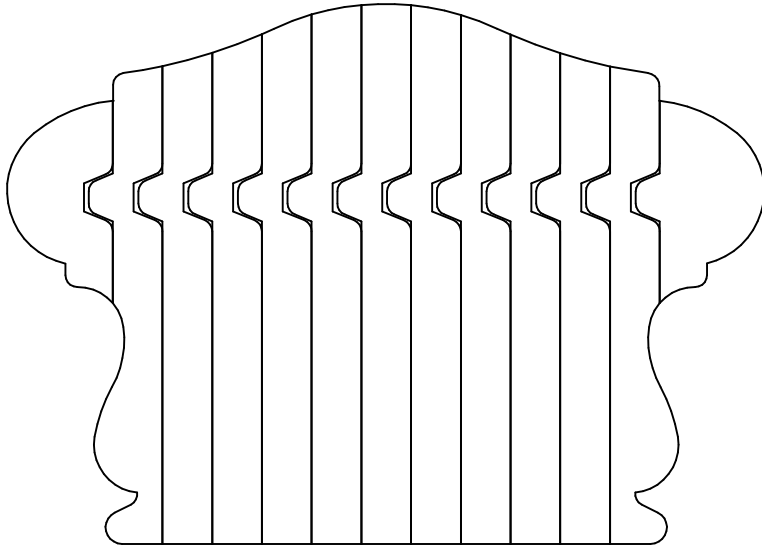

**KL 7935BR**  
2.812 x 3.944

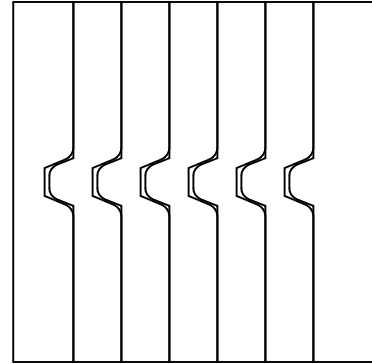

**KL 7936BR**  
1.875 x 1.875

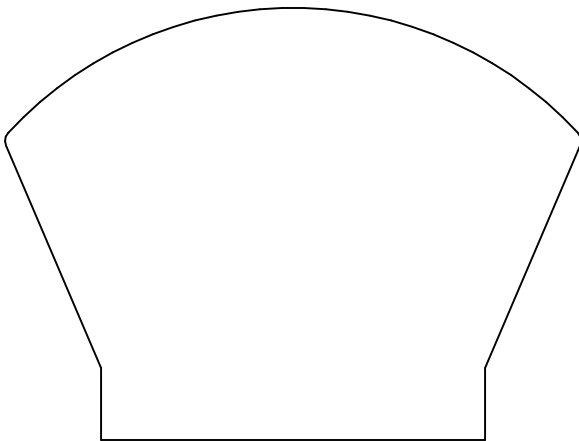

**KL 7937**  
2.250 x 3.000

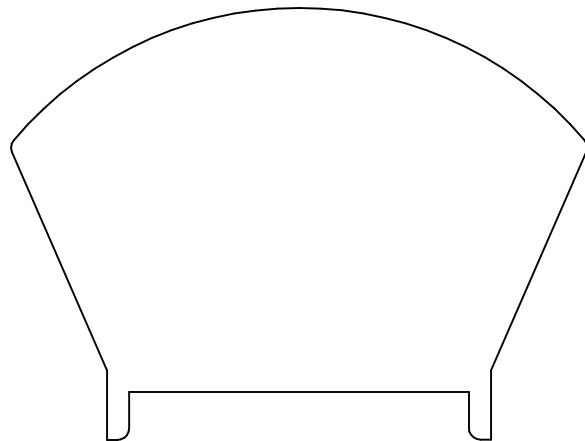

**KL 7937P**  
2.250 x 3.000

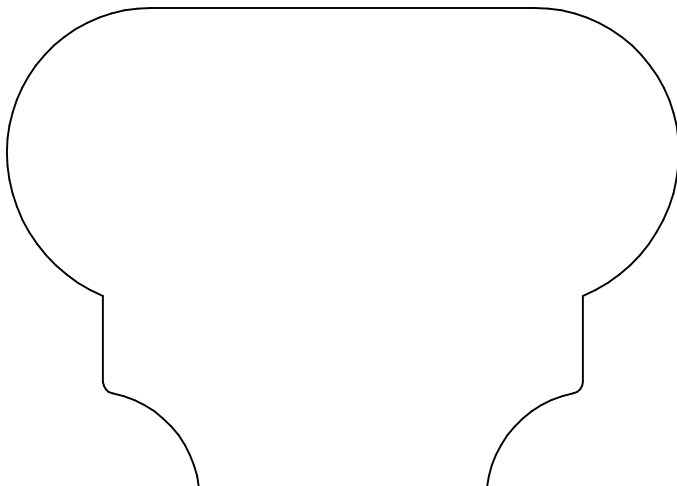

**KL 7938**  
2.500 x 3.500

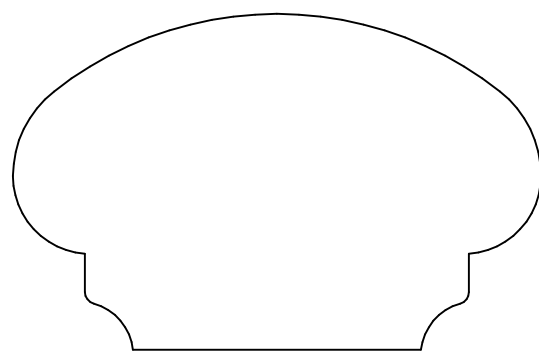

**KL 7939**  
1.750 x 2.750

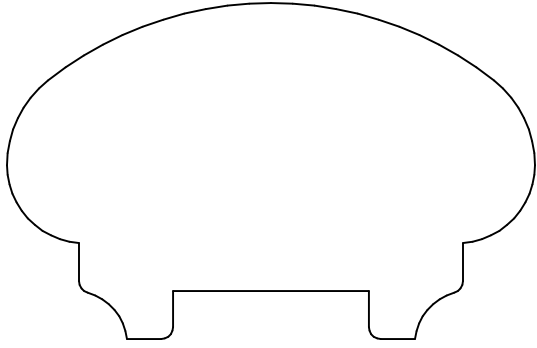

**KL 7939P**  
1.750 x 2.750

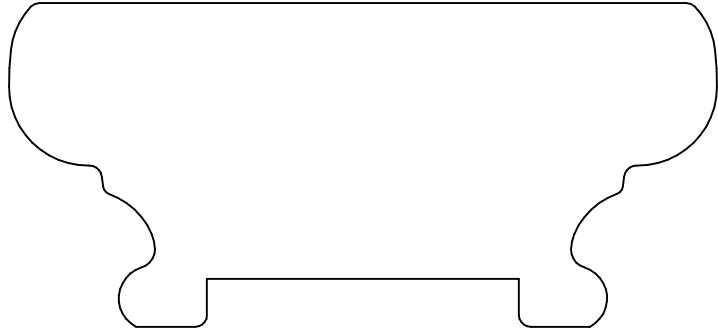

**KL 7940P**  
1.687 x 3.688

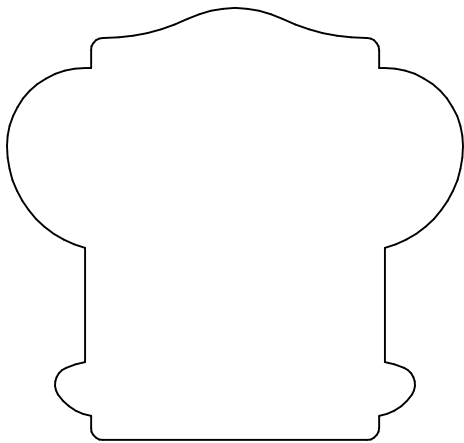

**KL 7941**  
2.250 x 2.375

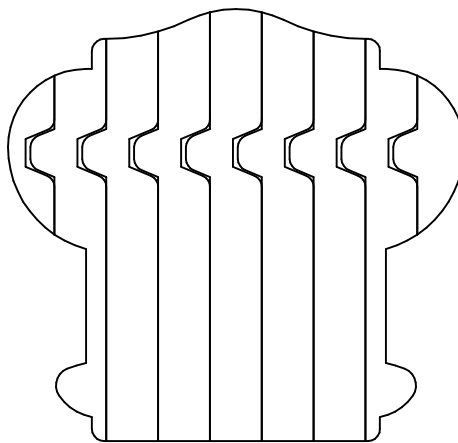

**KL 7941BR**  
2.250 x 2.375

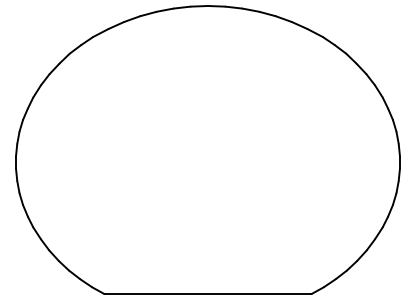

**KL 7946**  
1.500 x 2.000

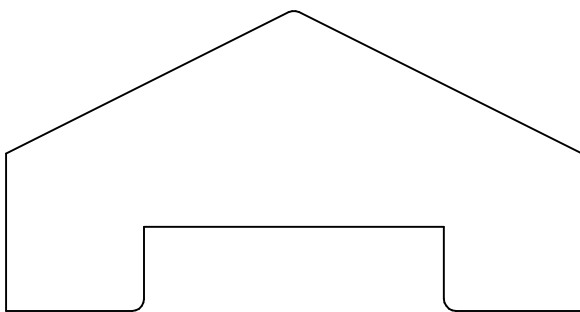

**KL 7943P**  
1.562 x 3.000

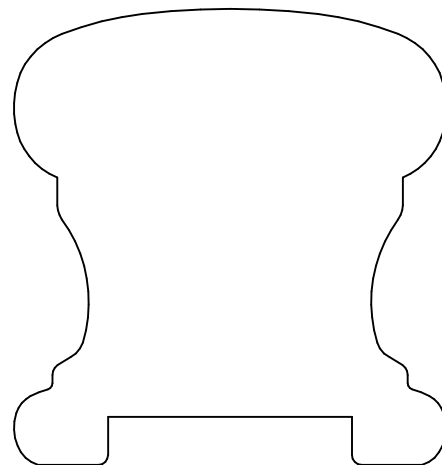

**KL 7945P**  
2.375 x 2.250

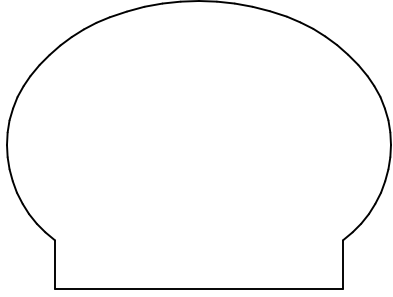

**KL 7947**  
1.500 x 2.000

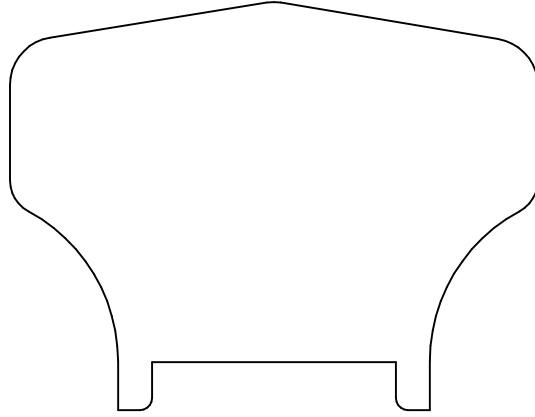

**KL 7948P**  
2.125 x 2.750

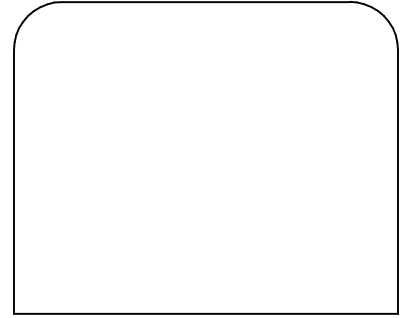

**KL 7949**  
1.625 x 2.000

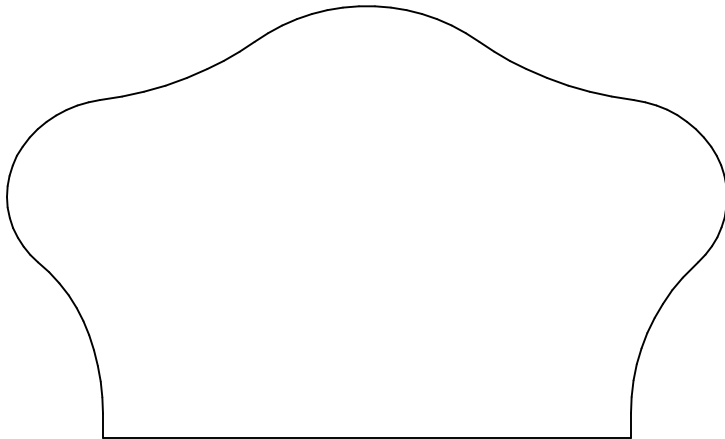

**KL 7950**  
2.250 x 3.750

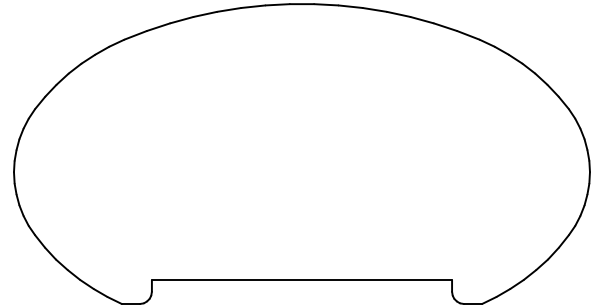

**KL 7953P**  
1.562 x 3.000

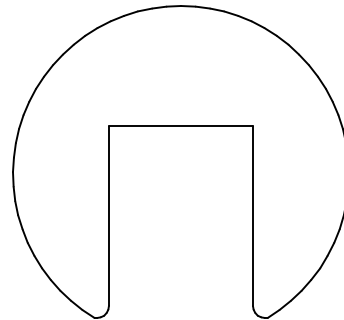

**KL 7954P**  
1.625 x 1.750

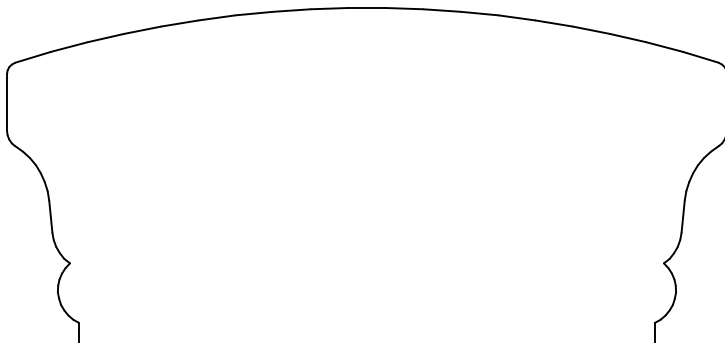

**KL 7951**  
1.750 x 3.750

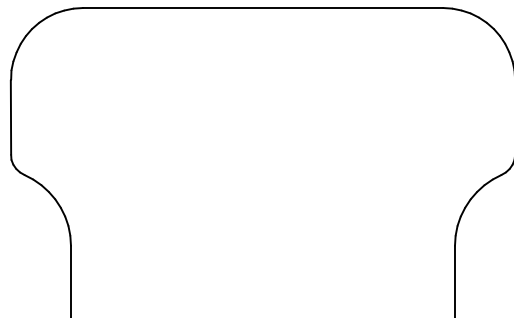

**KL 7958**  
1.625 x 2.625

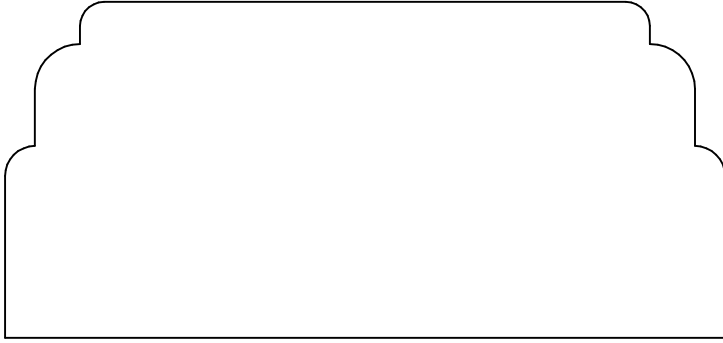

**KL 7952**  
1.750 x 3.750

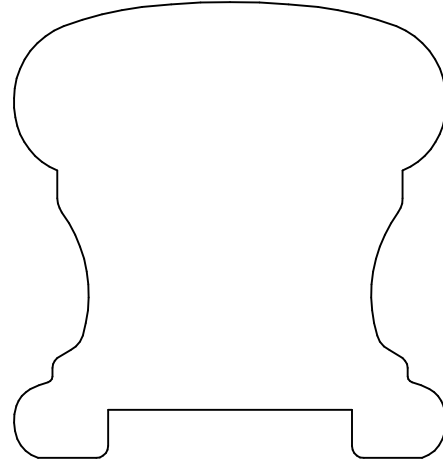

**KL 7956P**  
2.375 x 2.250

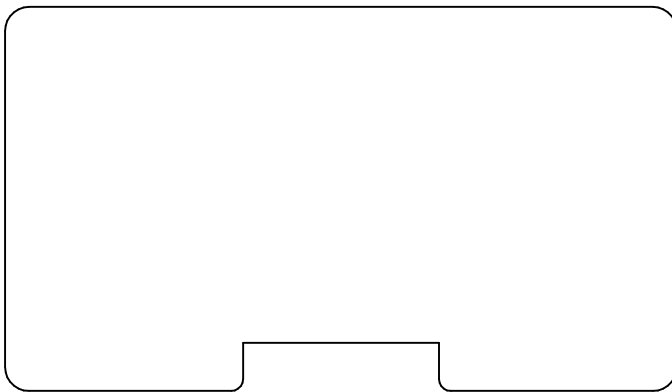

**KL 7955P**  
2.000 x 3.500

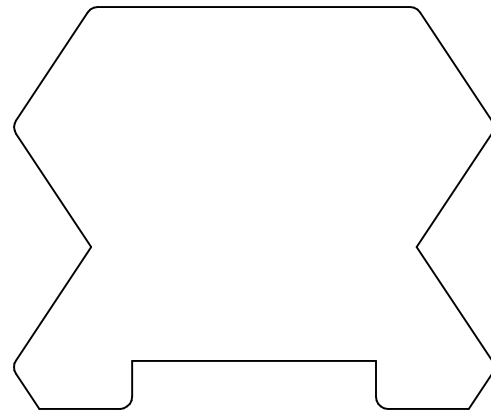

**KL 7957P**  
2.093 x 2.500

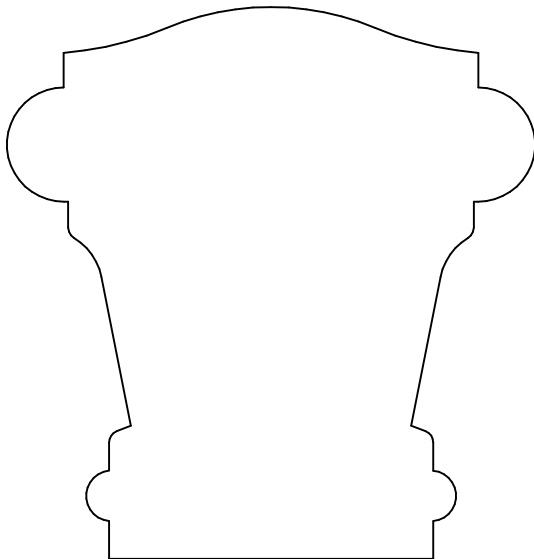

**KL 7959**  
2.875 x 2.750

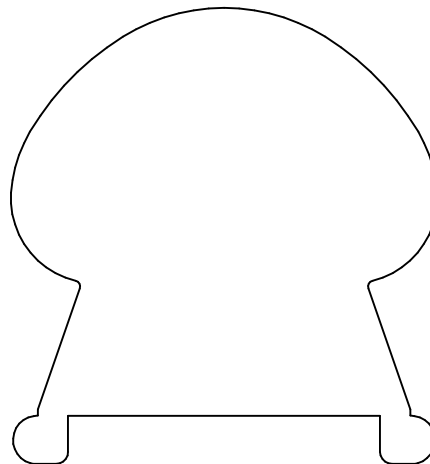

**KL 7960P**  
2.375 x 2.220

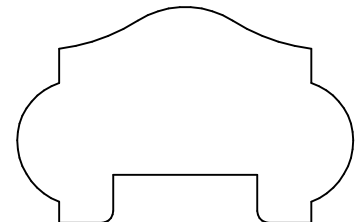

**KL 7978P**  
1.125 x 1.750

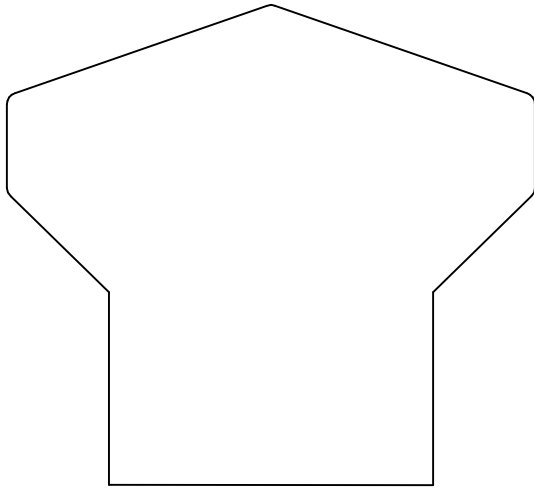

**KL7961**  
2.500 x 2.750

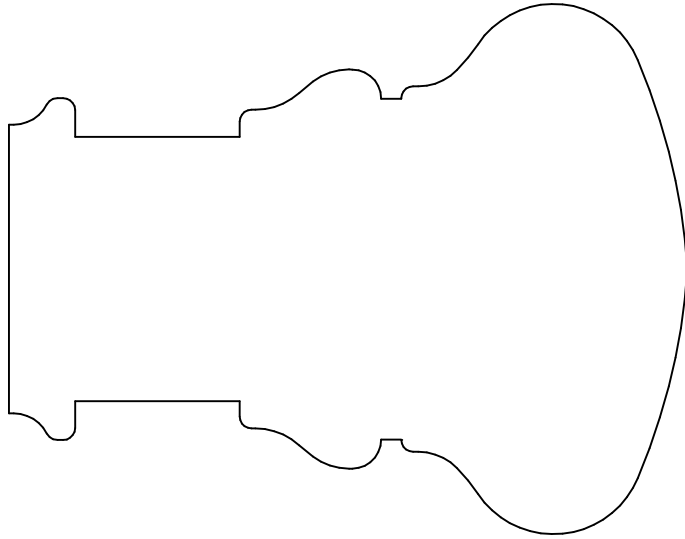

**KL 7962**  
3.532 x 2.762

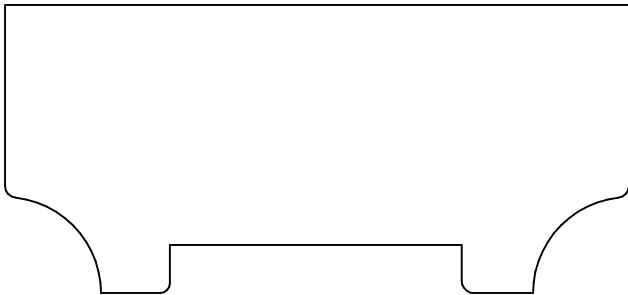

**KL 7963P**  
1.500 x 3.250

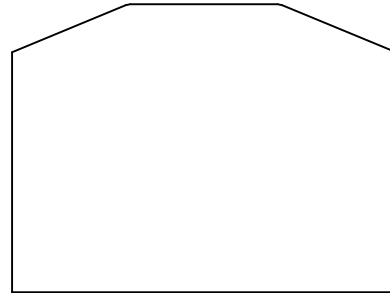

**KL 7964**  
1.500 x 2.000

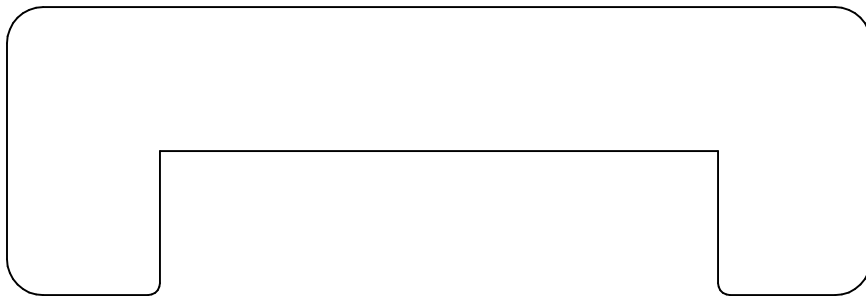

**KL 7965P**  
1.500 x 4.500

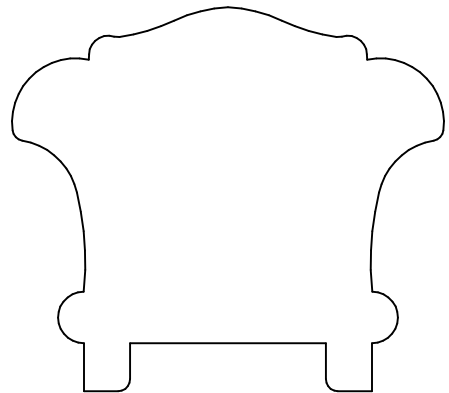

**KL 7967P**  
2.000 x 2.250

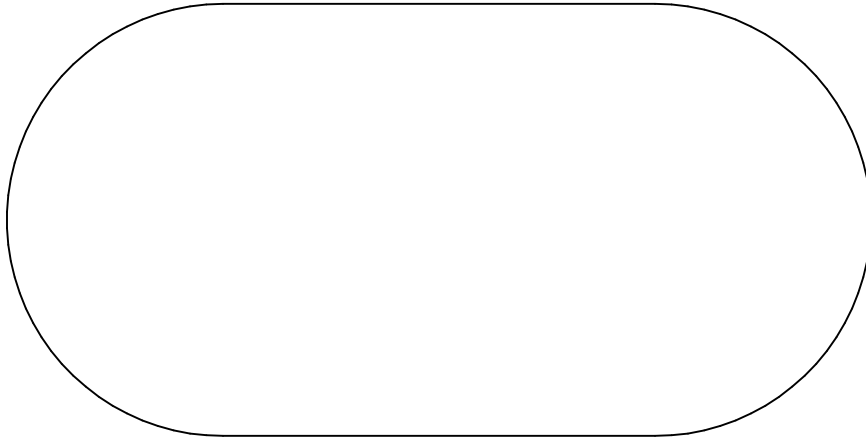

**KL 7966**  
2.250 x 4.500

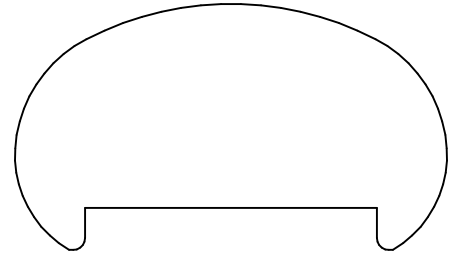

**KL 7969P**  
1.281 x 2.250

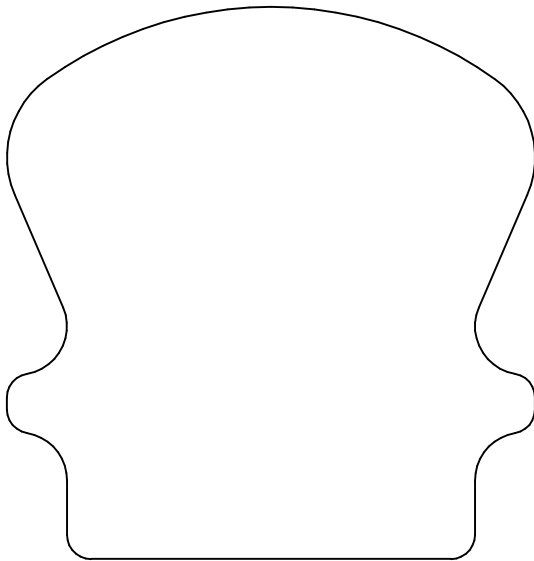

**KL 7968**  
2.875 x 2.750

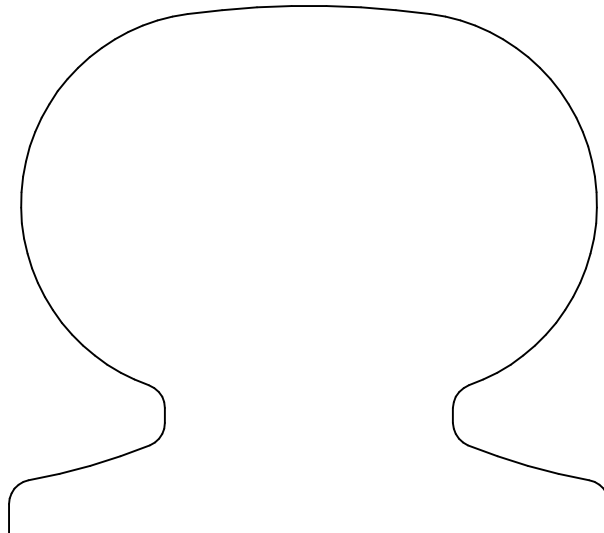

**KL 7970**  
2.750 x 3.125

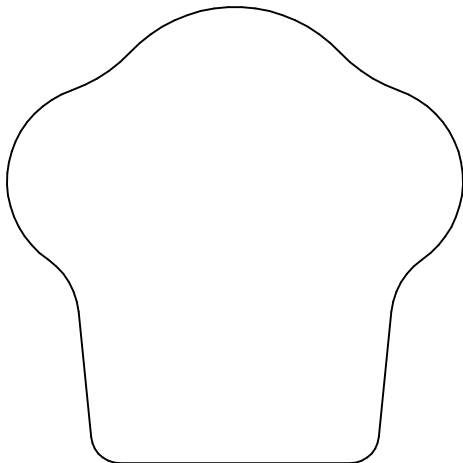

**KL 7971**  
2.375 x 2.375

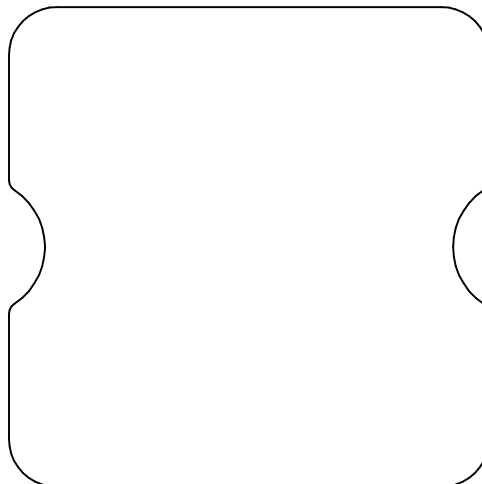

**KL 7972**  
2.500 x 2.500

**Keim**  
BUILT ON TRUST, SINCE 1911

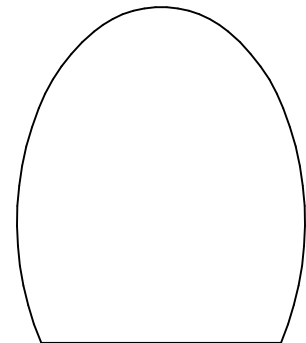

**KL 7988**  
1.750 x 1.500

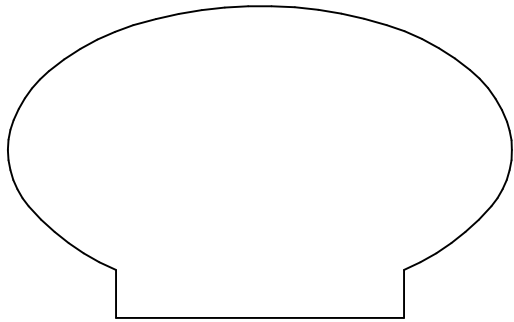

**KL 7973**  
1.625 x 2.625

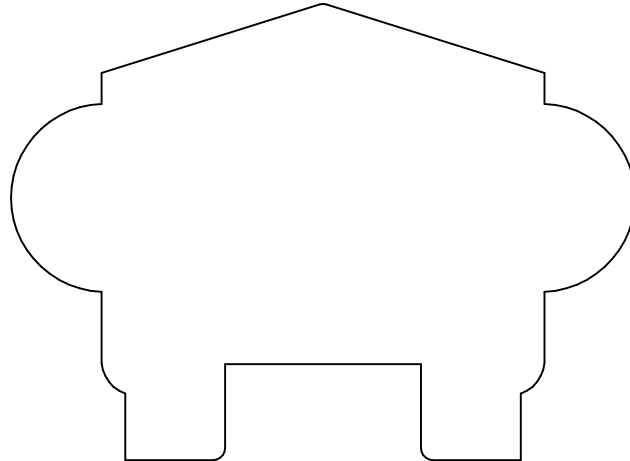

**KL 7974P**  
2.375 x 3.250

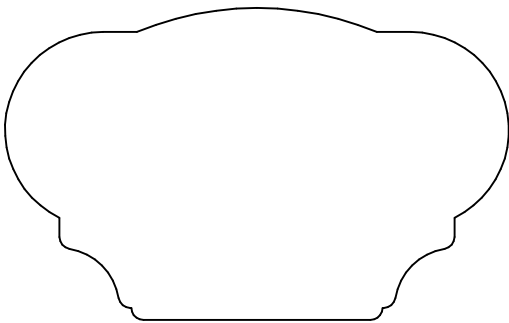

**KL 7975**  
1.625 x 2.625

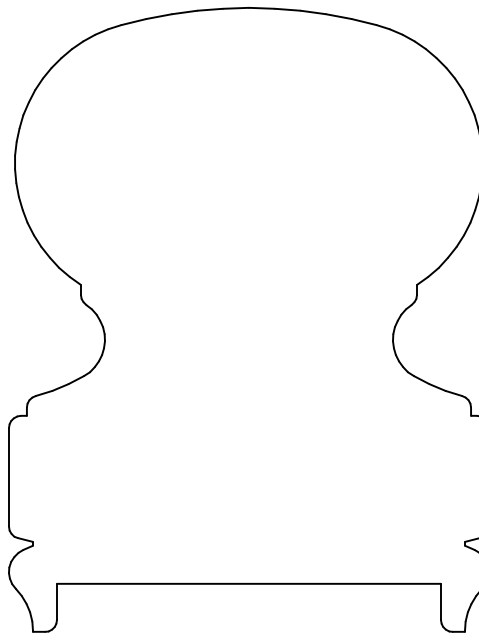

**KL 7977P**  
3.250 x 2.500

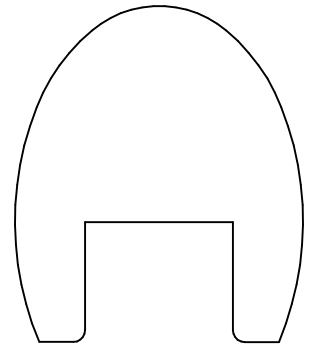

**KL 7988P**  
1.750 x 1.500

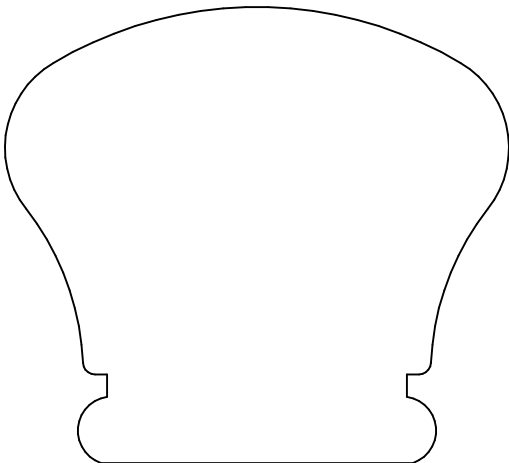

**KL 7976**  
2.375 x 2.625

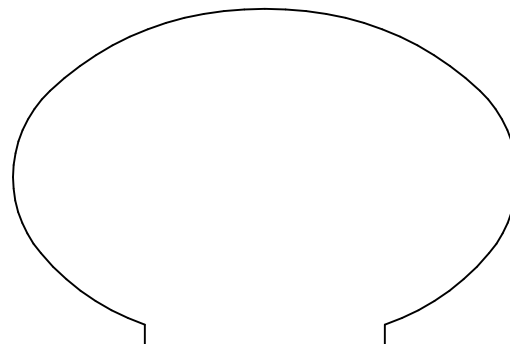

**KL 7979**  
1.750 x 2.625

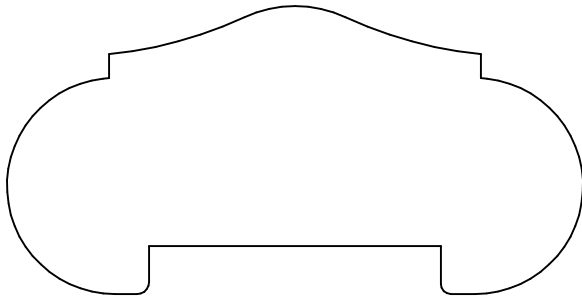

**KL 7980P**  
1.500 x 3.000

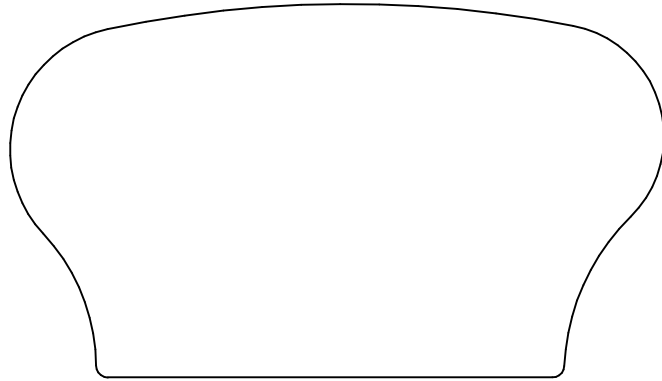

**KL 7981**  
1.945 x 3.407

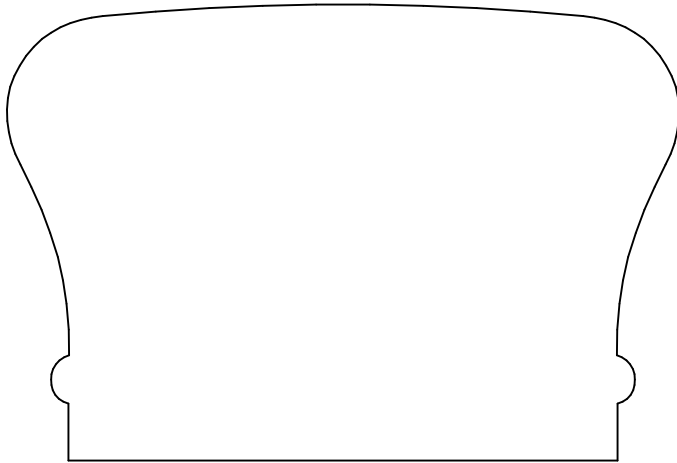

**KL 7982**  
2.375 x 3.500



**KL 7983P**  
1.562 x 2.750

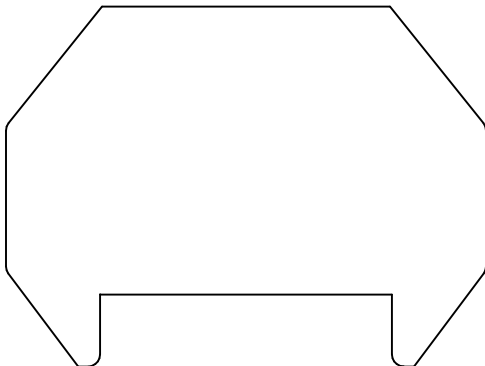

**KL 7985P**  
1.875 x 2.500

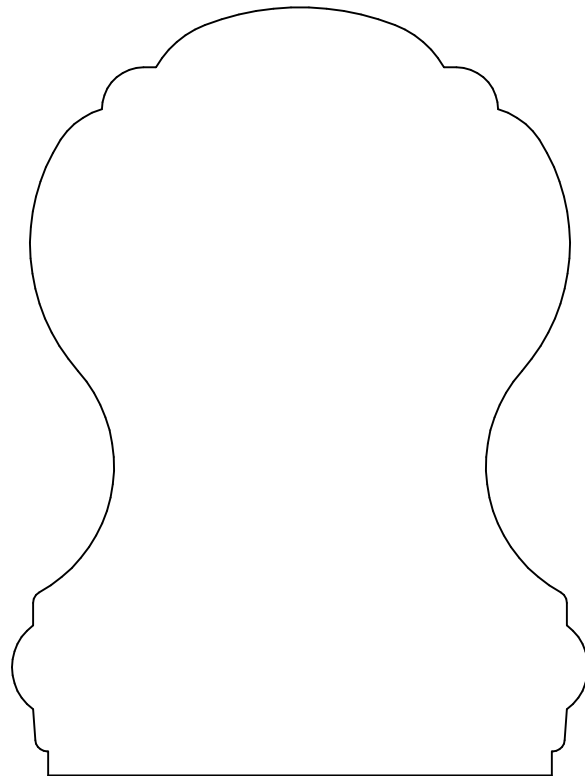

**KL 7984**  
4.000 x 3.000



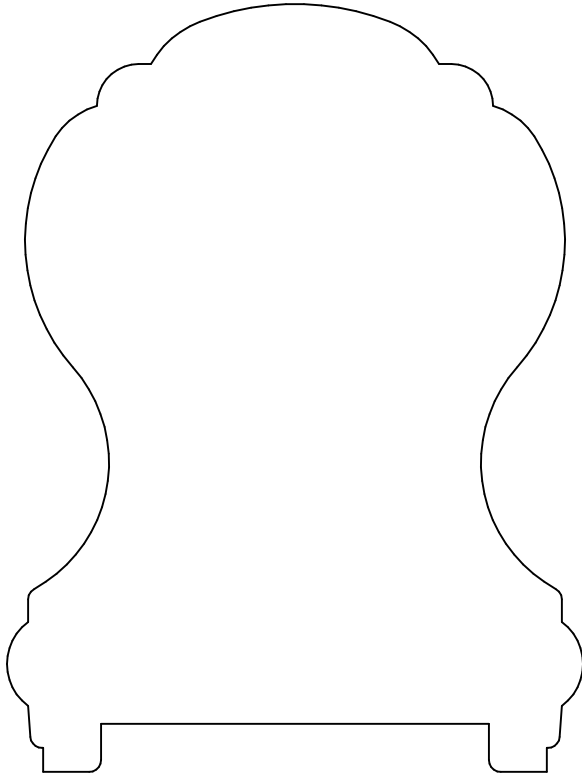

**KL 7984P**  
4.000 x 3.000

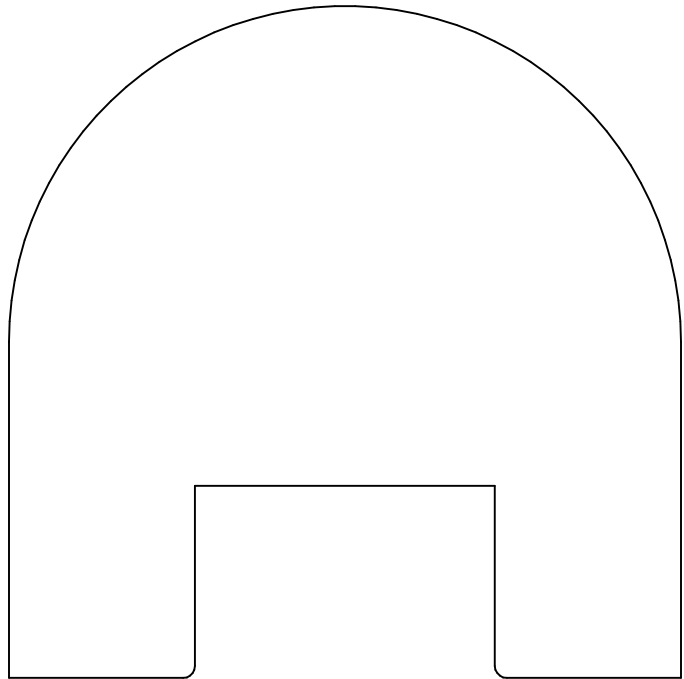

**KL 7986P**  
3.500 x 3.500

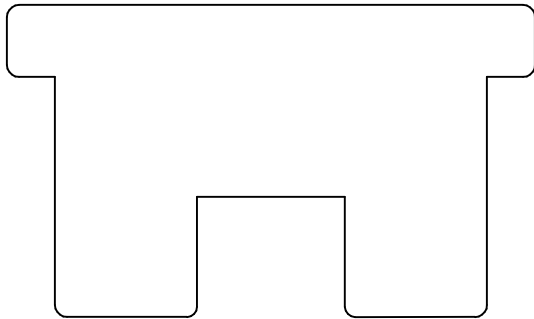

**KL 7987P**  
1.625 x 2.750

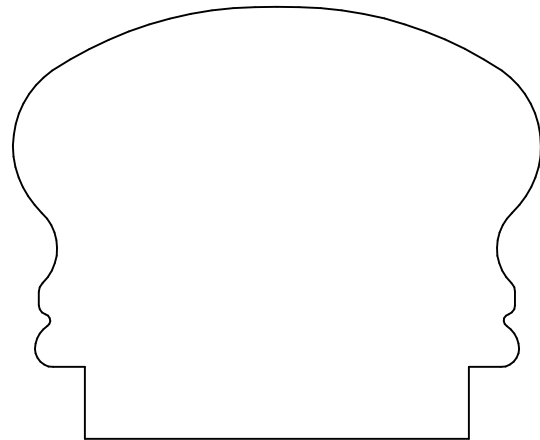

**KL 7989**  
2.250 x 2.750

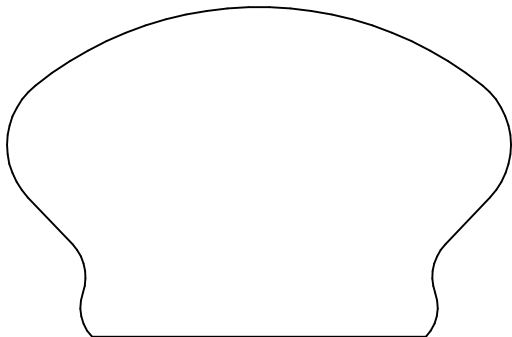

**KL 7992**  
1.718 x 2.625

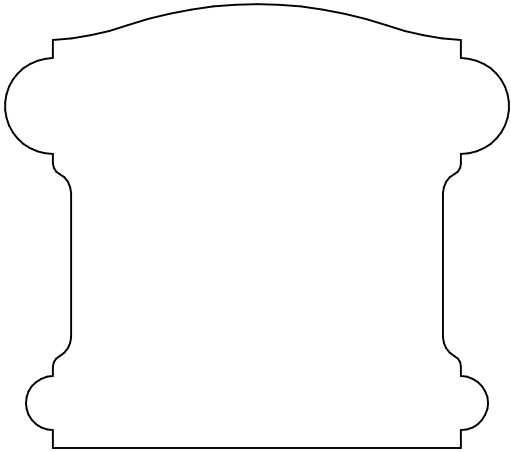

**KL 7990**  
2.312 x 2.625

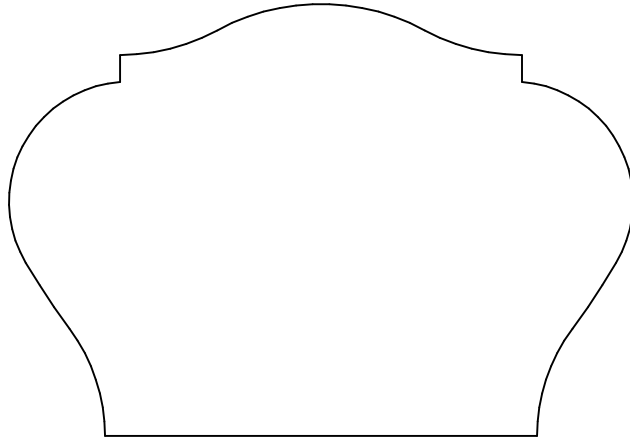

**KL 7993**  
2.250 x 3.250

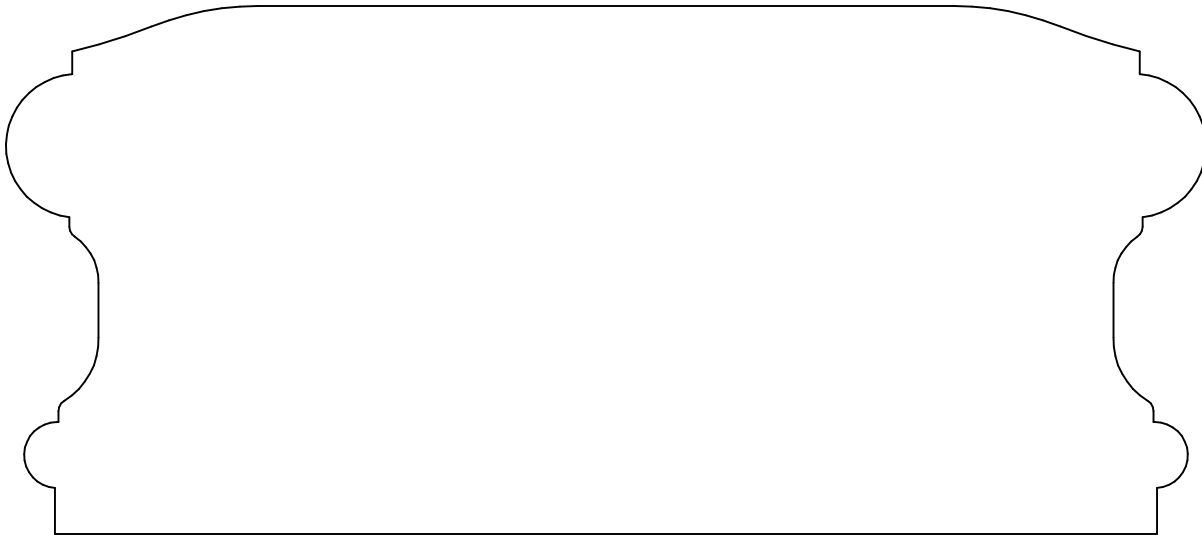

**KL 7991**  
2.750 x 6.250

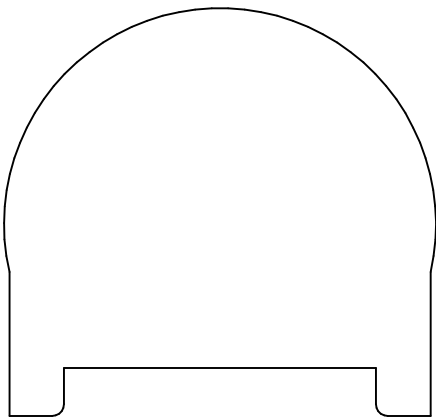

**KL 7994 P**  
2.125 x 2.250

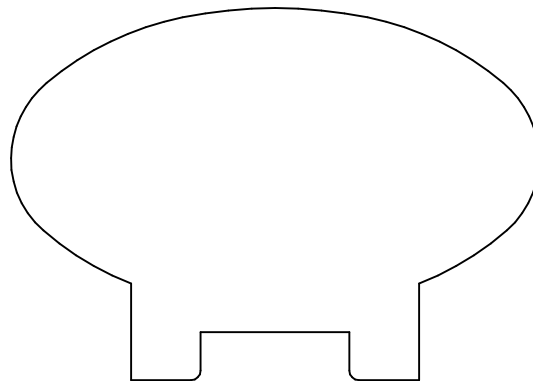

**KL 7996P**  
1.938 x 2.750



**KL 7991P**  
2.750 x 6.250

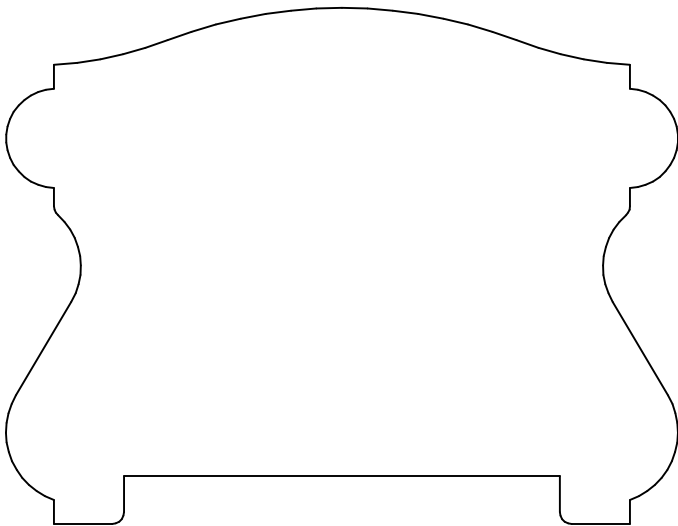

**KL 7995P**  
2.687 x 3.500

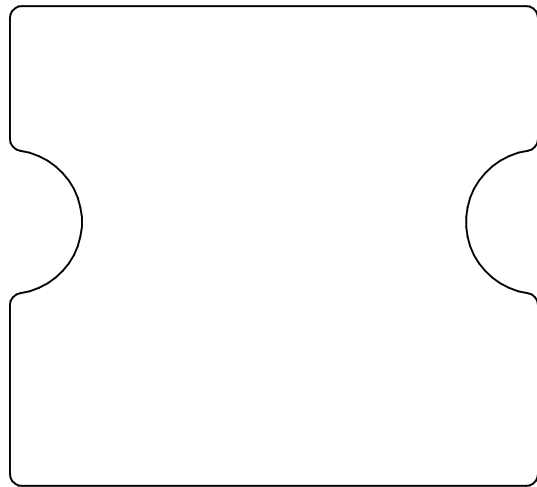

**KL 7997**  
2.500 x 2.750

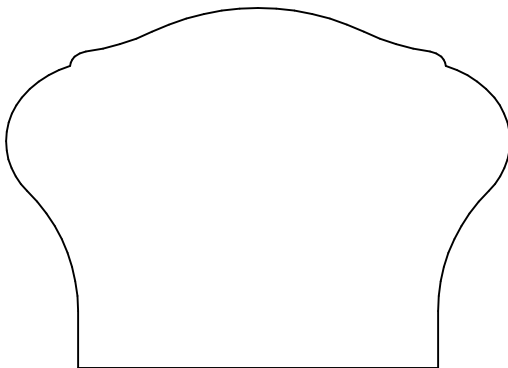

**KL 7999**  
1.875 x 2.625

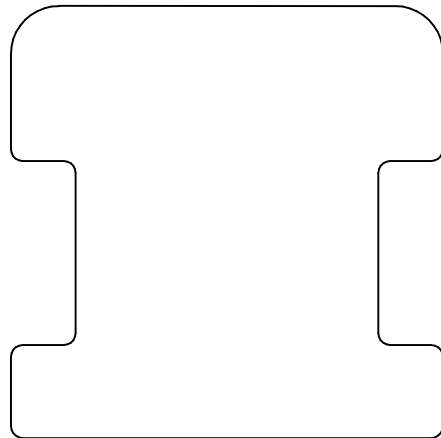

**KL 7998**  
2.250 x 2.250

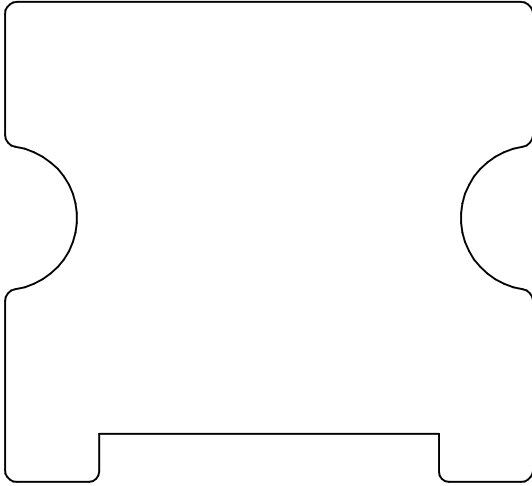

**KL 7997P**  
2.500 x 2.750

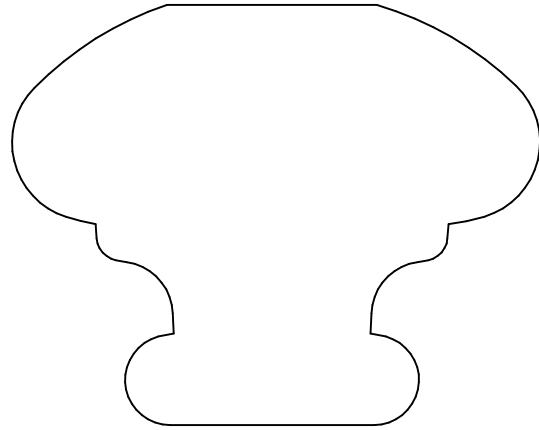

**KL 9903**  
2.187 x 2.750

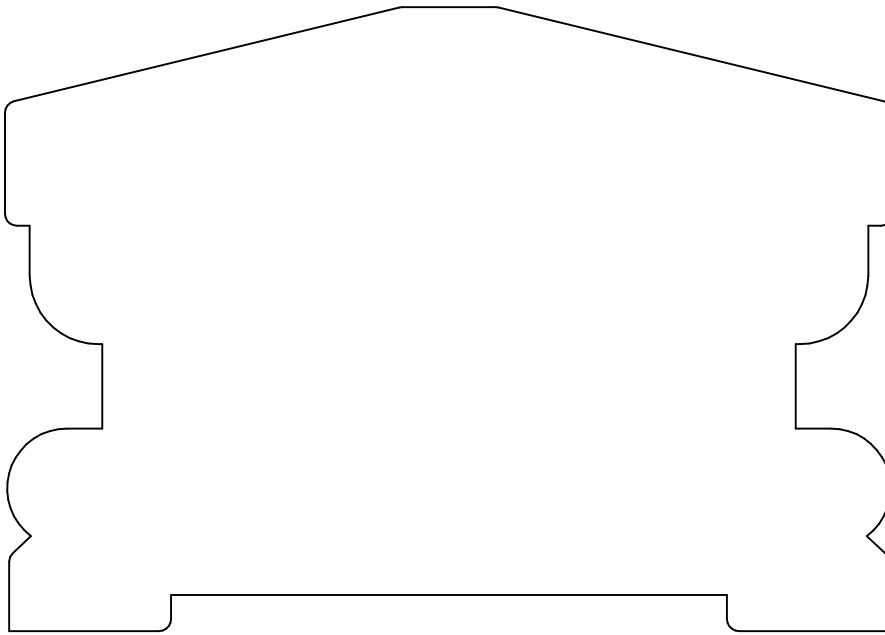

**KL 9900P**  
3.250 x 4.625

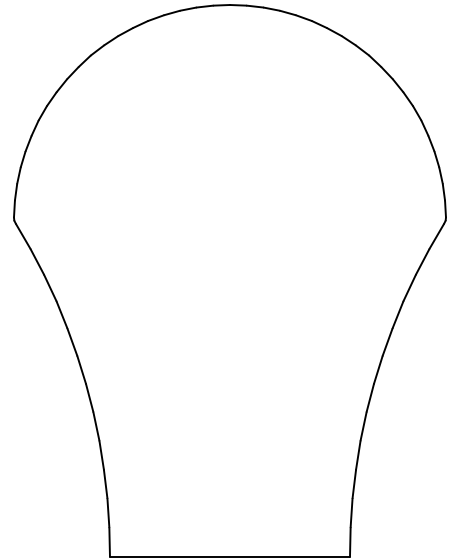

**KL 9904**  
2.875 x 2.250

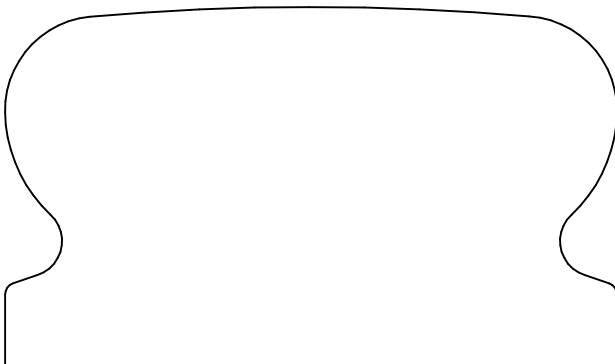

**KL 9905**  
1.875 x 3.188

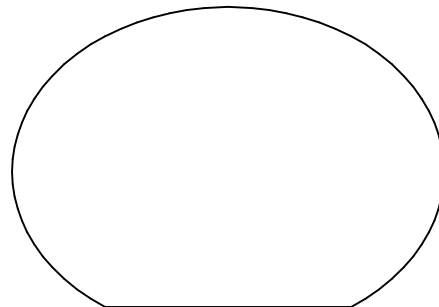

**KL 9910**  
1.562 x 2.250

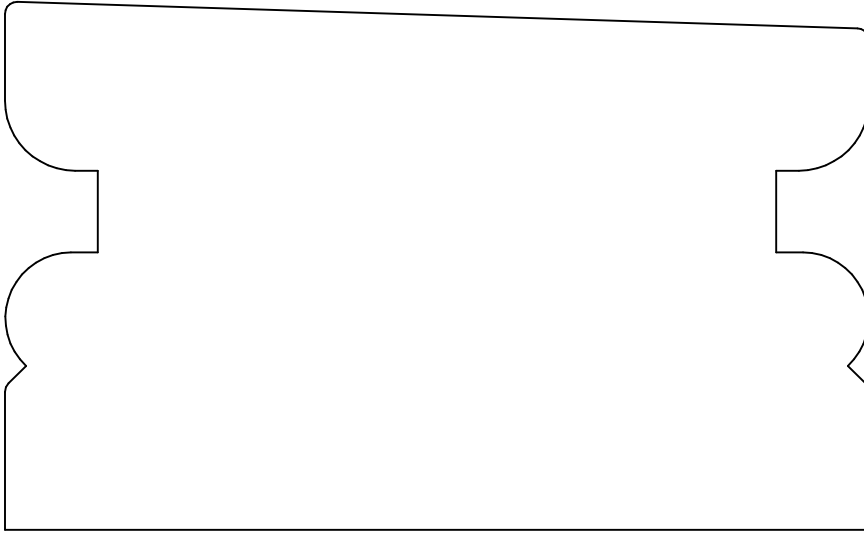

**KL 9901**  
2.750 x 4.500

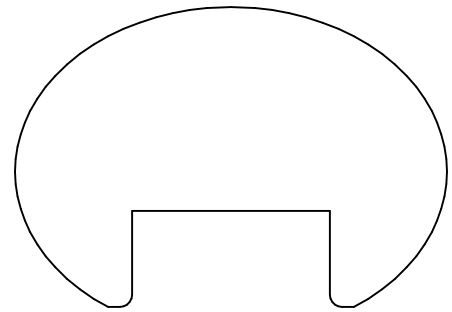

**KL 9910P**  
1.562 x 2.250

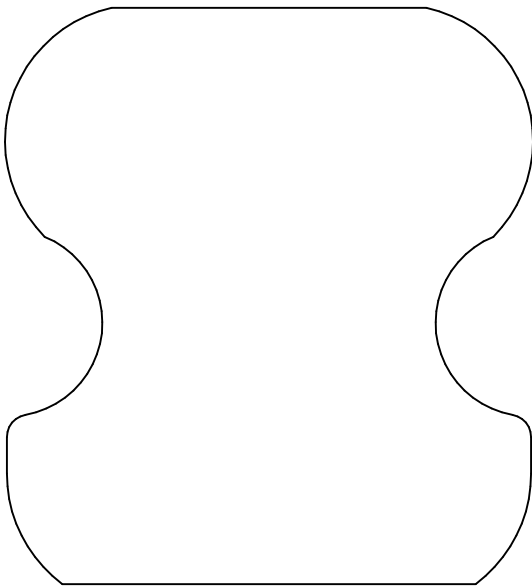

**KL 9902**  
3.000 x 2.750

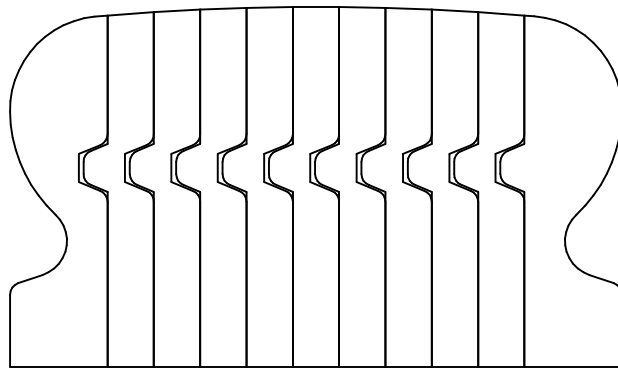

**KL 9905B**  
2.500 x 3.500

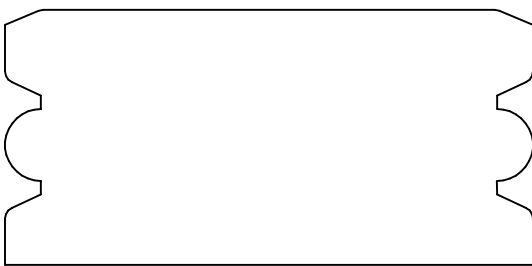

**KL 9914**  
1.328 x 2.750

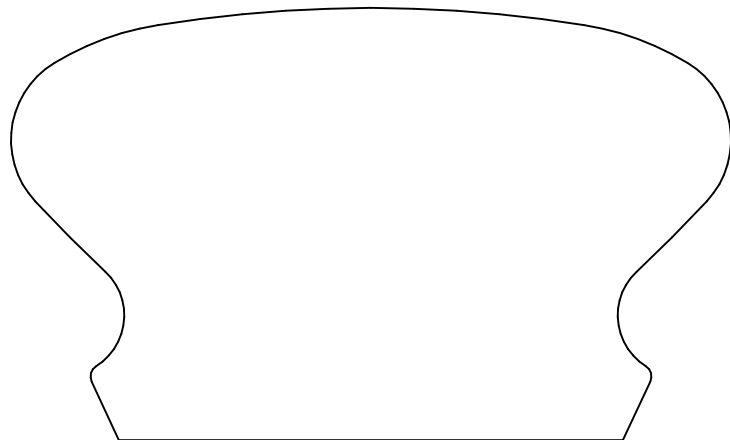

**KL 9906**  
2.250 x 3.750

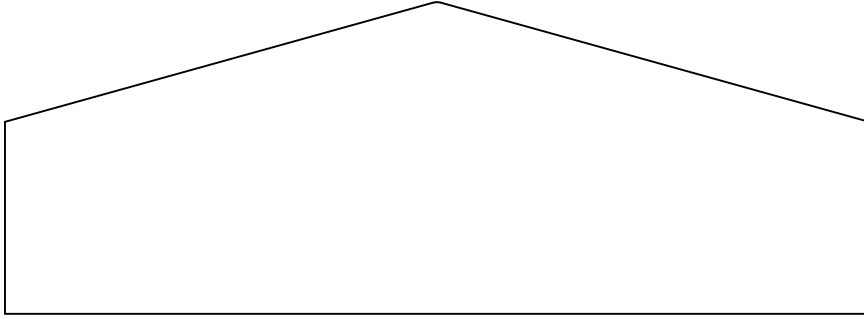

**KL 9907**  
1.625 x 4.500

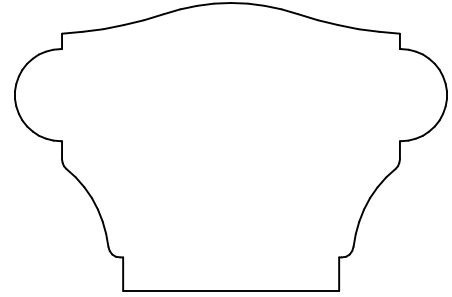

**KL 9916**  
1.500 x 2.250

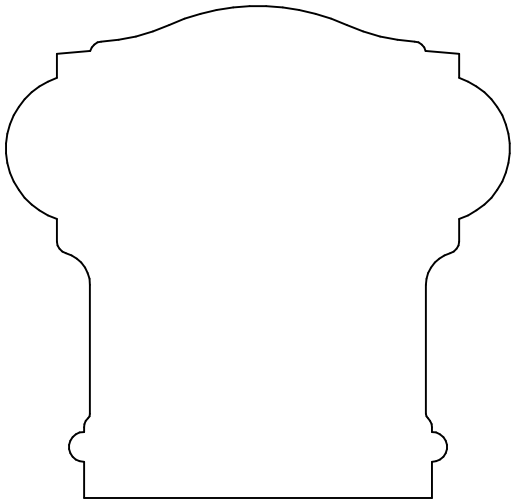

**KL 9908**  
2.562 x 2.625

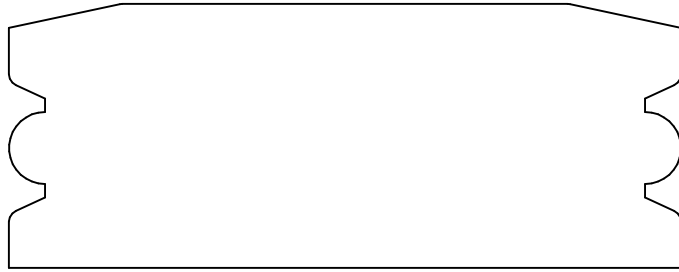

**KL 9913**  
1.375 x 3.500

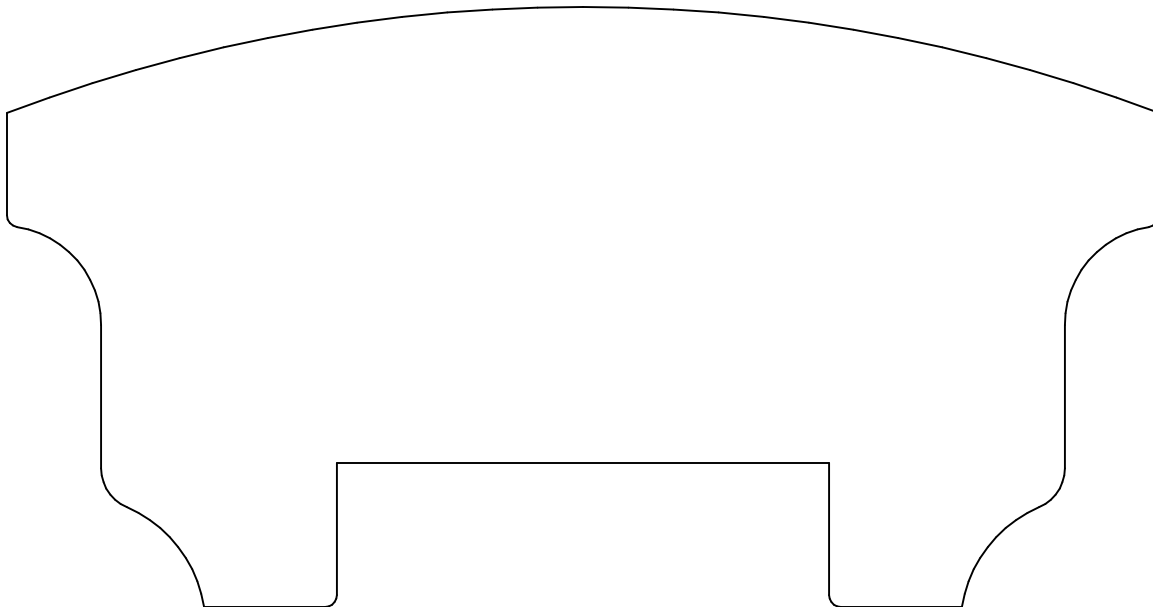

**KL 9909**  
3.125 x 6.000

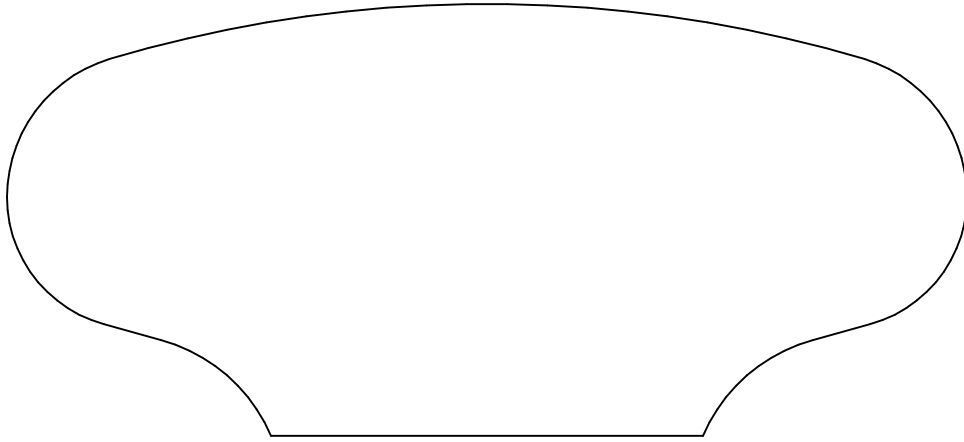

**KL 9911**  
2.250 x 5.000

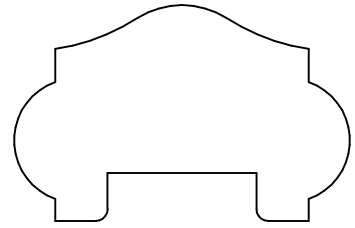

**KL 9920 P**  
1.125 x 1.750

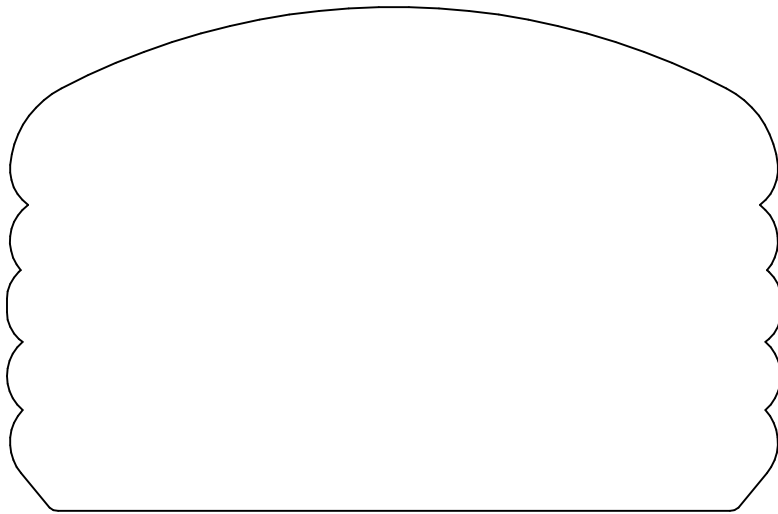

**KL 9912**  
2.625 x 4.031

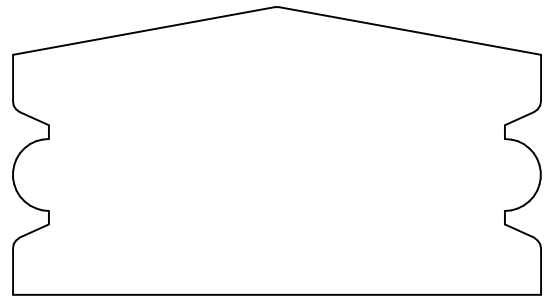

**KL 9915**  
1.500 x 2.750

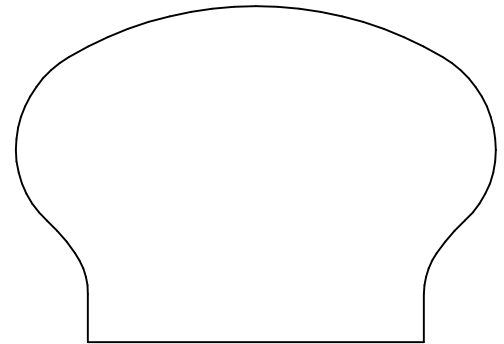

**KL 9921**  
1.750 x 2.500

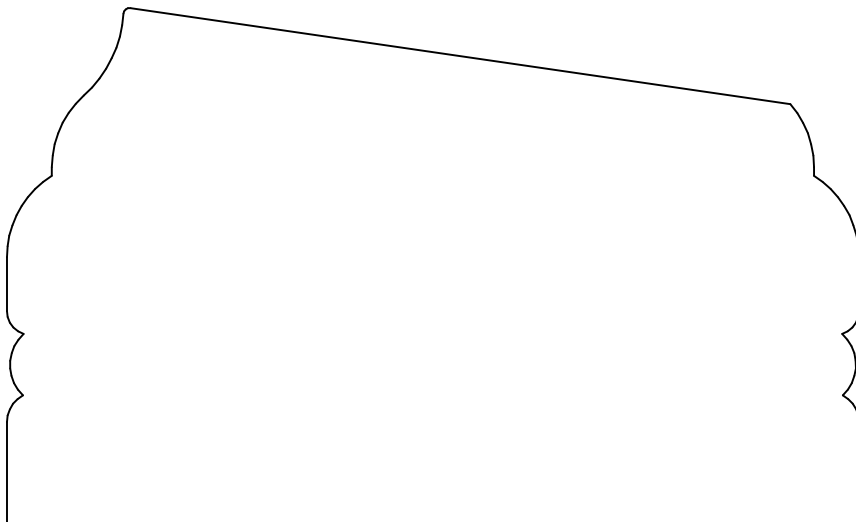

**KL 9917**  
2.688 x 4.437

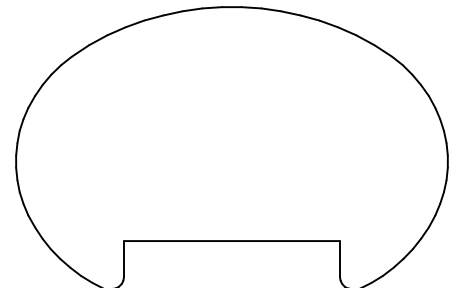

**KL 9924P**  
1.469 x 2.250

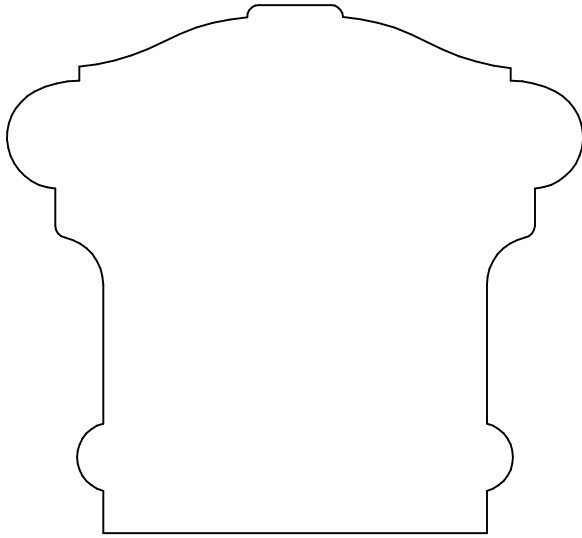

**KL 9918**  
2.750 x 3.000

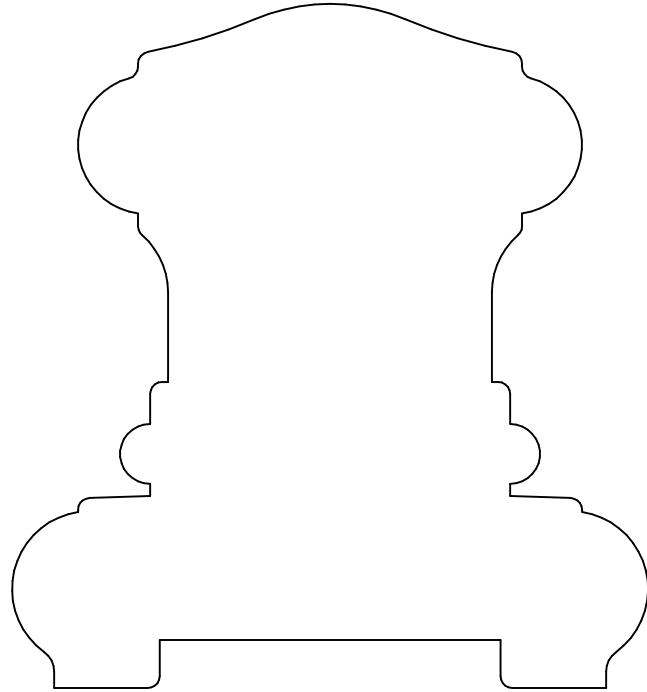

**KL 9919 P**  
3.562 x 3.313

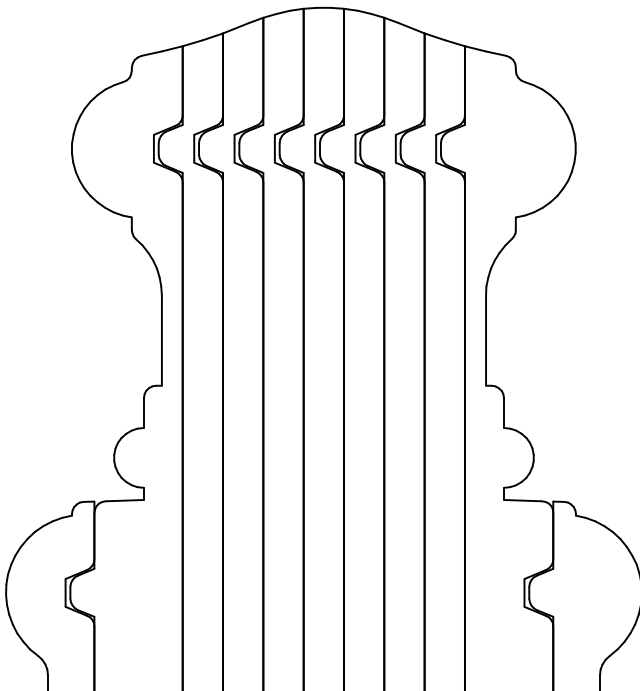

**KL 9919B**  
2.500 x 3.500

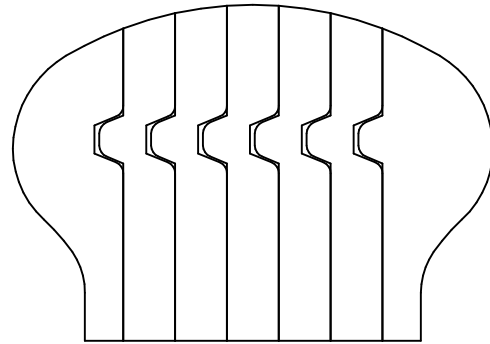

**KL 9921B**  
1.750 x 2.500



**KL 9930**  
.813 x 3.000



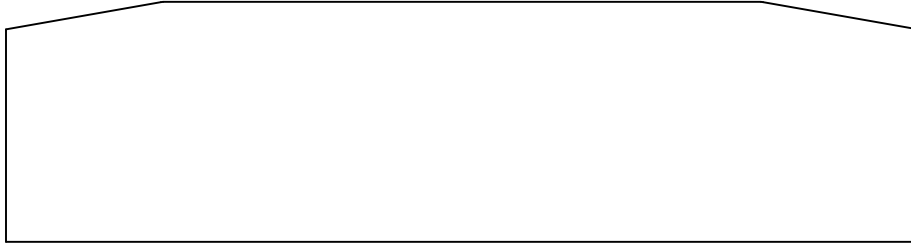

**KL 9922**  
1.250 x 4.750

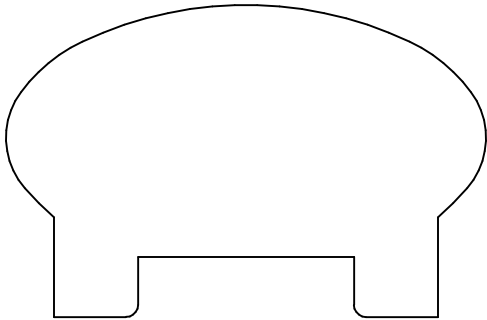

**KL 9923P**  
1.625 x 2.500

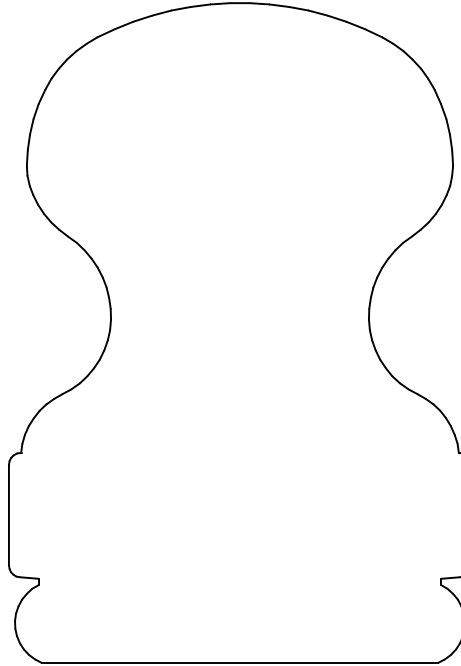

**KL 9925**  
3.437 x 2.406

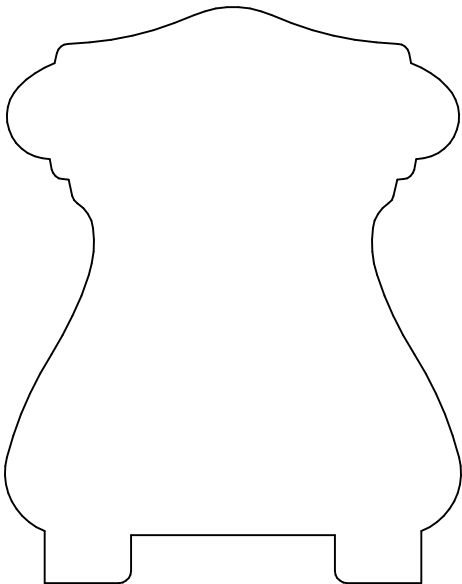

**KL 9926P**  
3.000 x 2.375

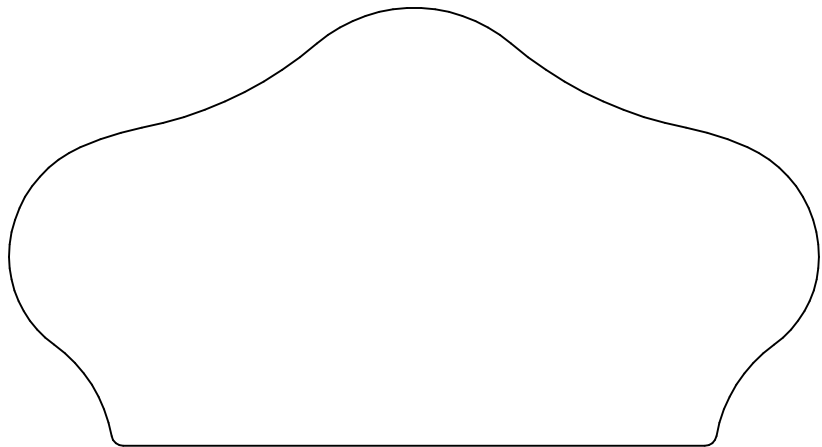

**KL 9927**  
2.281 x 4.219

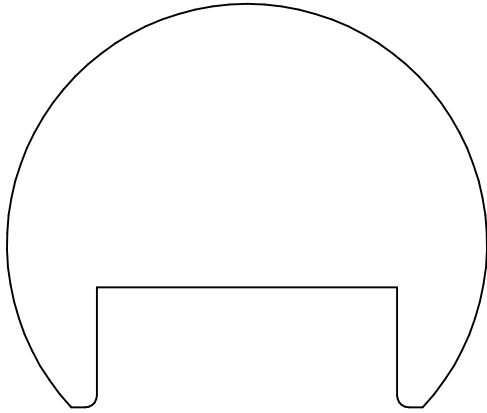

**KL 9928P**  
2.101 x 2.500

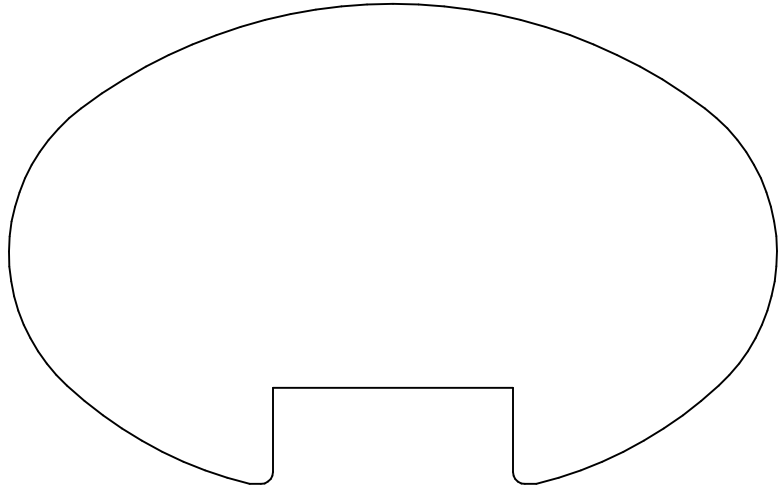

**KL 9929P**  
2.500 x 4.000

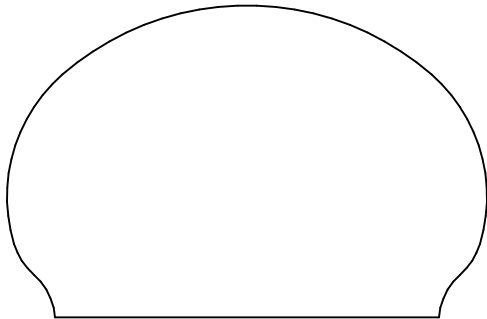

**KL 9931**  
1.625 x 2.500

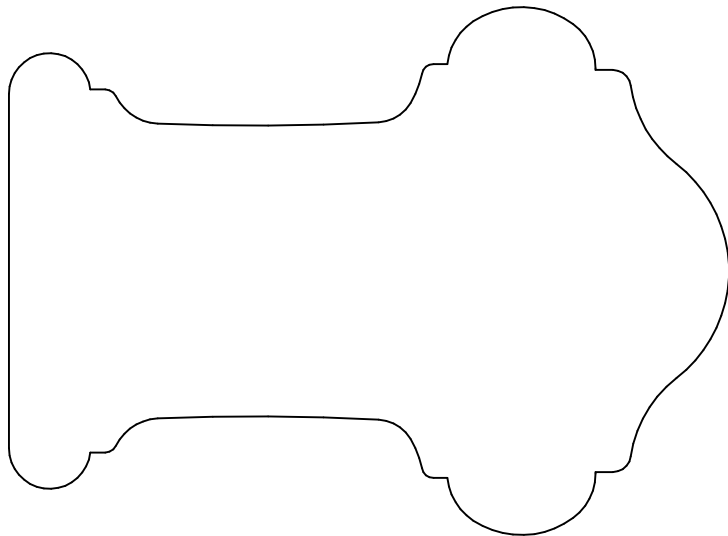

**KL 9932**  
2.750 x 3.750

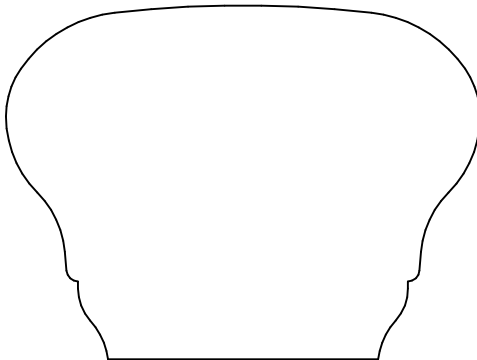

**KL 9935**  
1.844 x 2.469

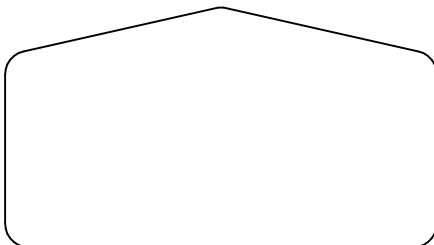

**KL 9945**  
1.250 x 2.250

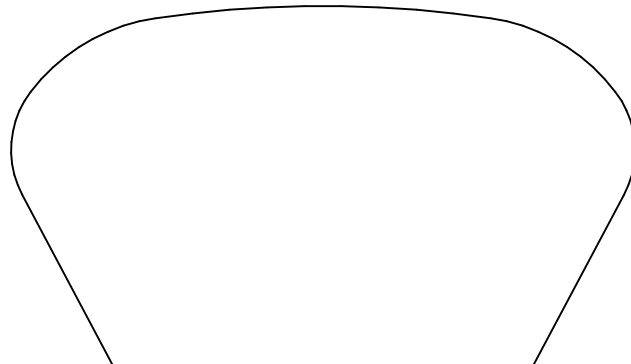

**KL 9936**  
1.875 x 3.250

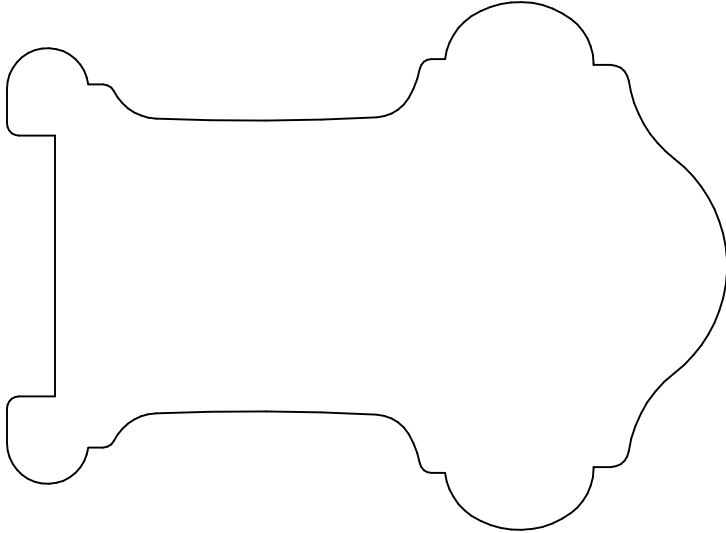

**KL 9932P**  
2.750 x 3.750

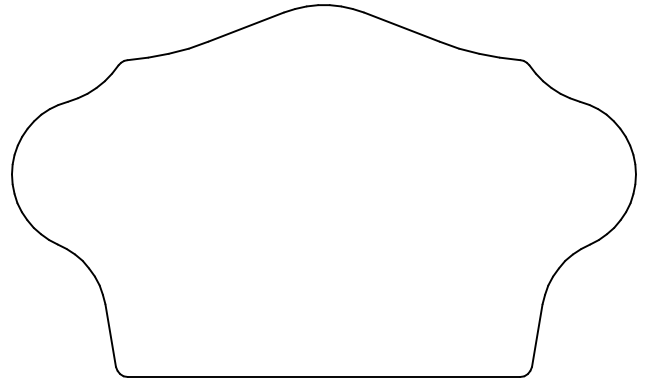

**KL 9938**  
1.938 x 3.250

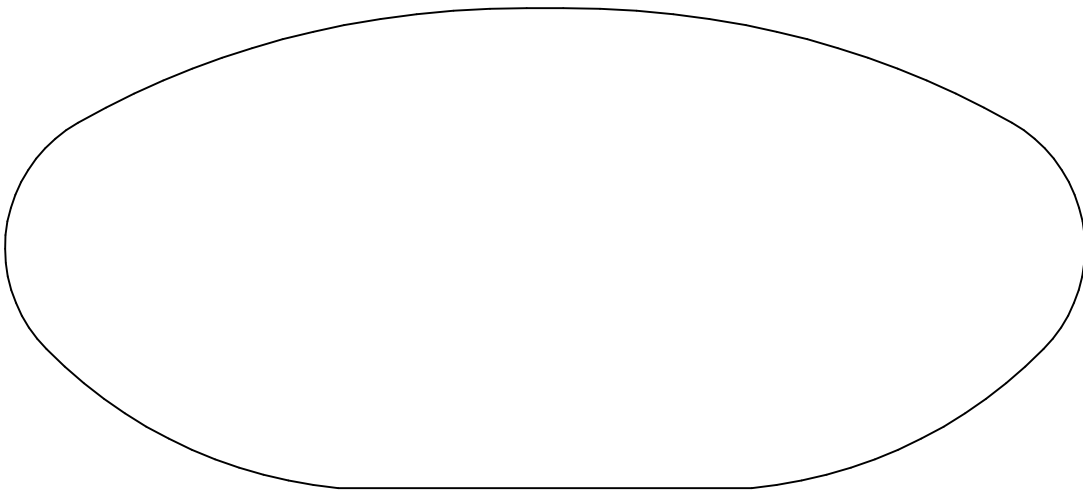

**KL 9933**  
2.500 x 5.625

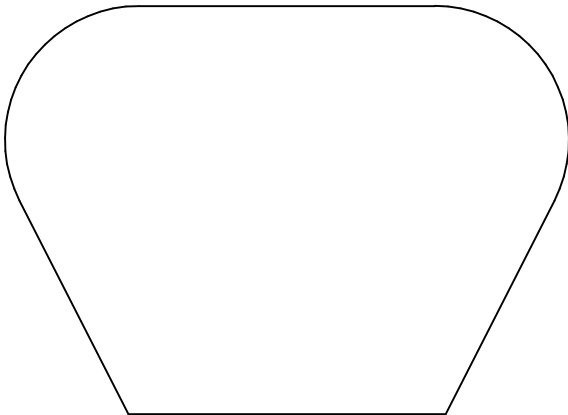

**KL 9939**  
2.125 x 2.938

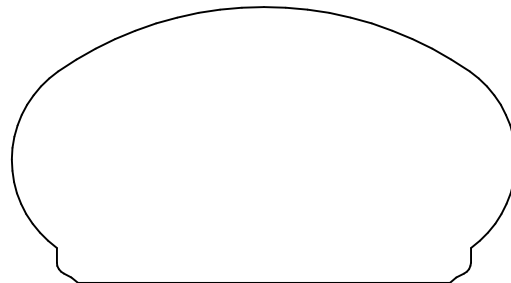

**KL 9940**  
1.438 x 2.625

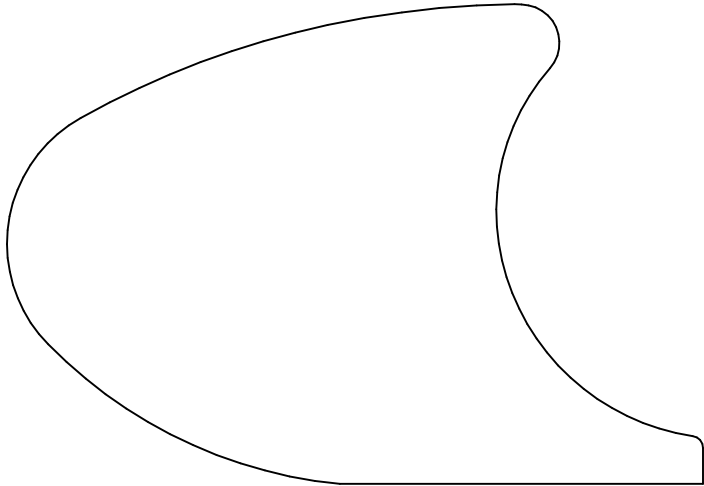

**KL 9934**  
2.500 x 3.625

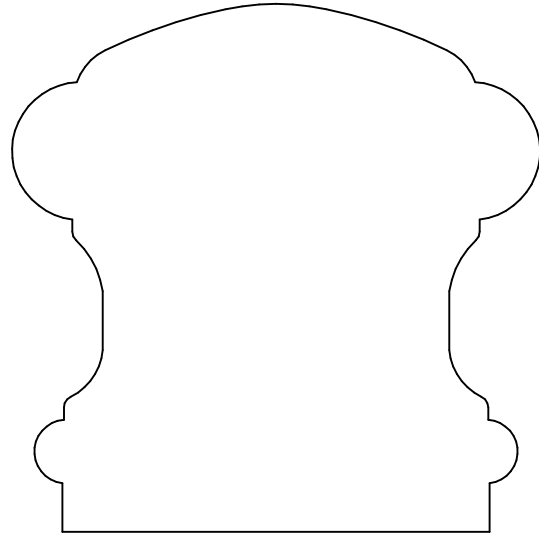

**KL 9941**  
2.750 x 2.750

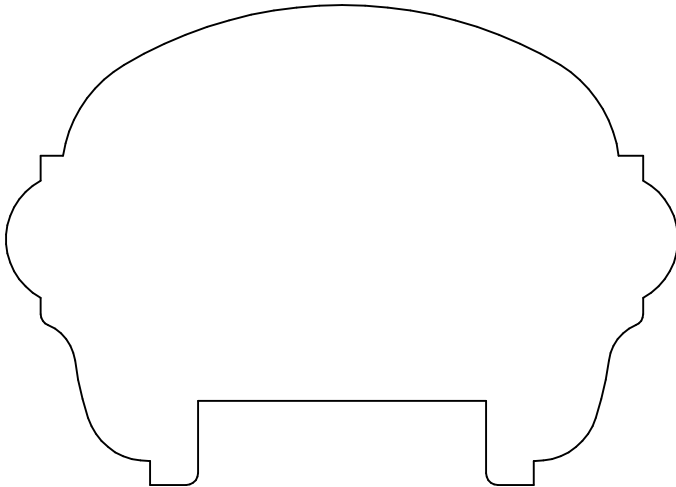

**KL 9937P**  
2.500 x 3.500

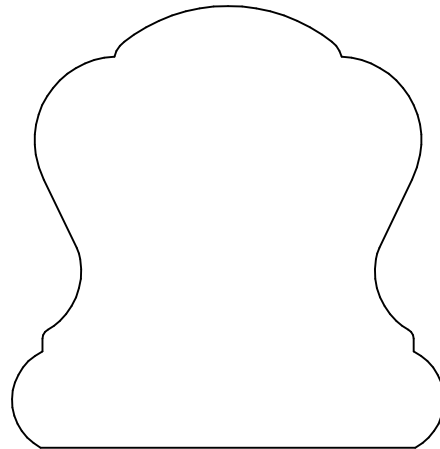

**KL 9942**  
2.300 x 2.250

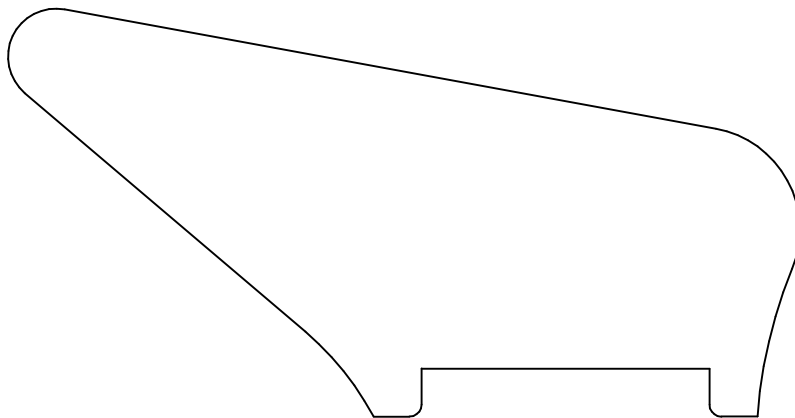

**KL 9943P**  
2.125 x 4.125

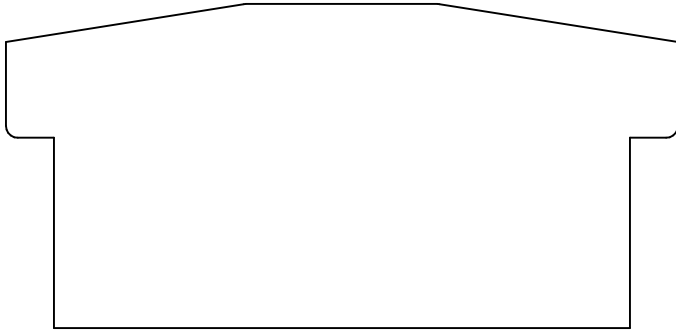

**KL 9944**  
1.688 x 3.500

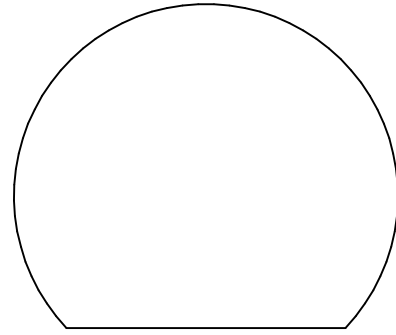

**KL 9947**  
1.687 x 2.000

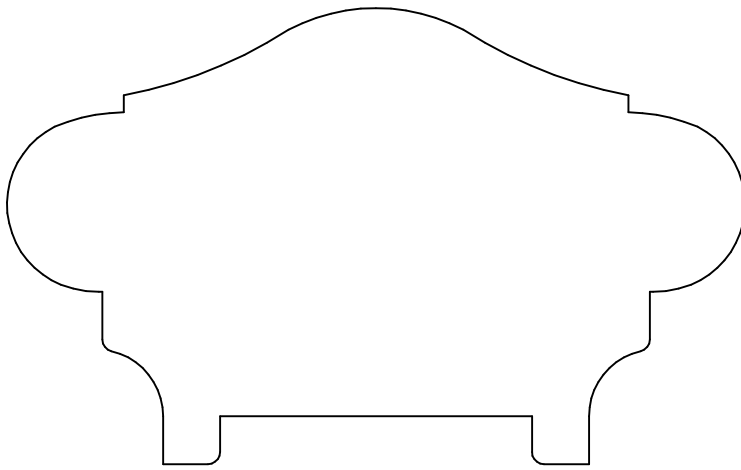

**KL 9946P**  
2.375 x 3.844

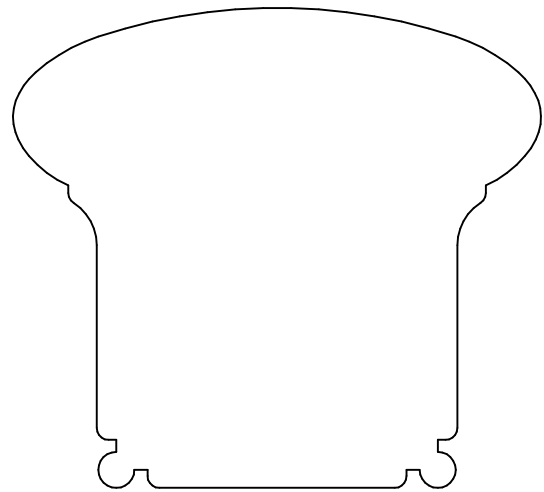

**KL 9949**  
2.500 x 2.750

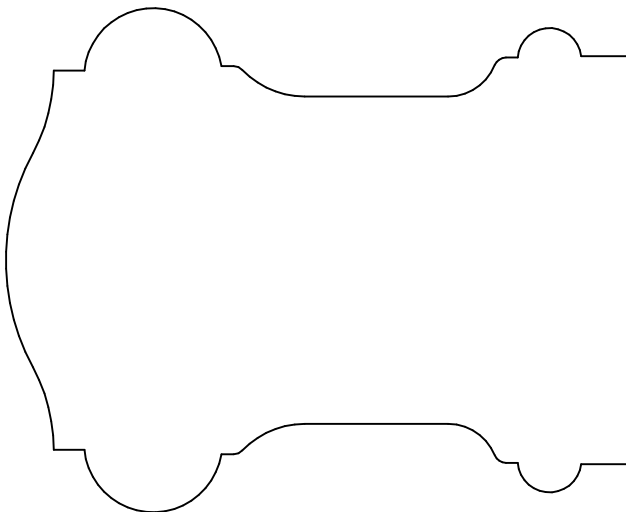

**KL 9948**  
3.250 x 2.625

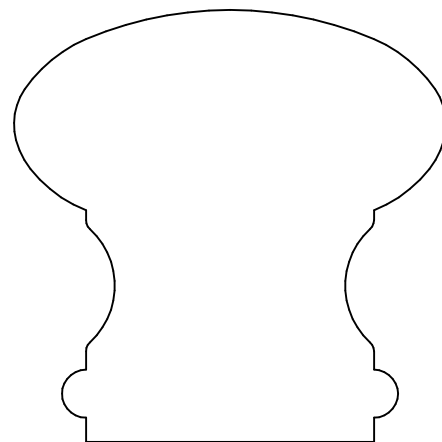

**KL 9950**  
2.250 x 2.250

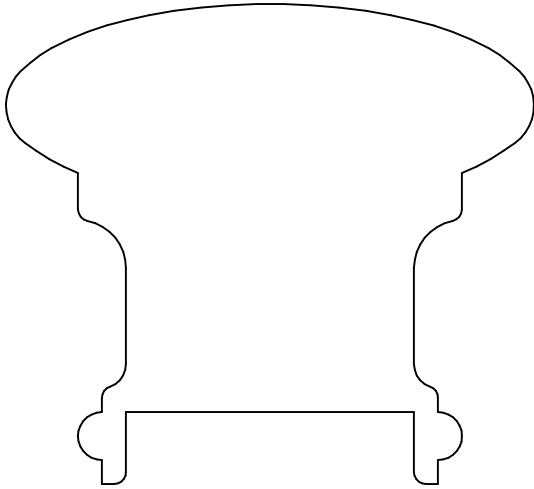

**KL 9951P**  
2.500 x 2.750

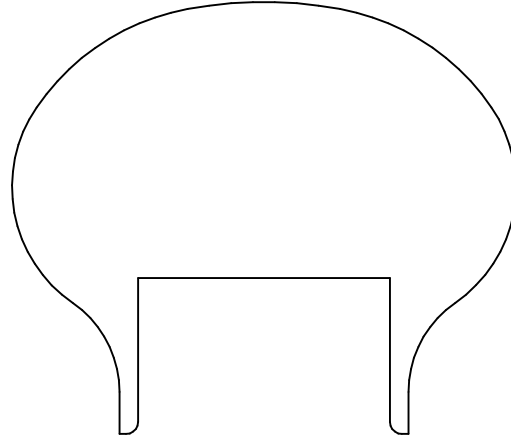

**KL 9952P**  
2.250 x 2.625

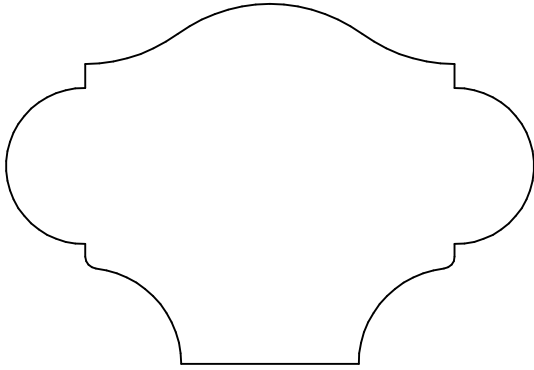

**KL 9953**  
1.875 x 2.750

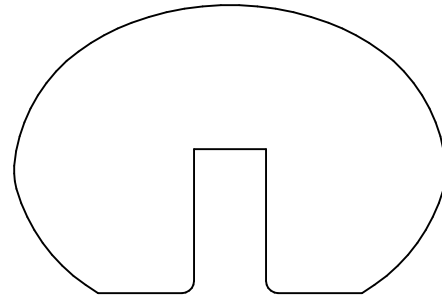

**KL 9954P**  
1.500 x 2.250

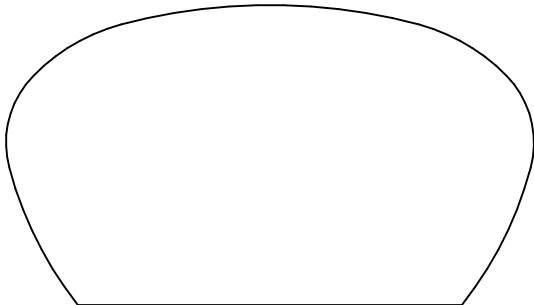

**KL 9955**  
1.562 x 2.750

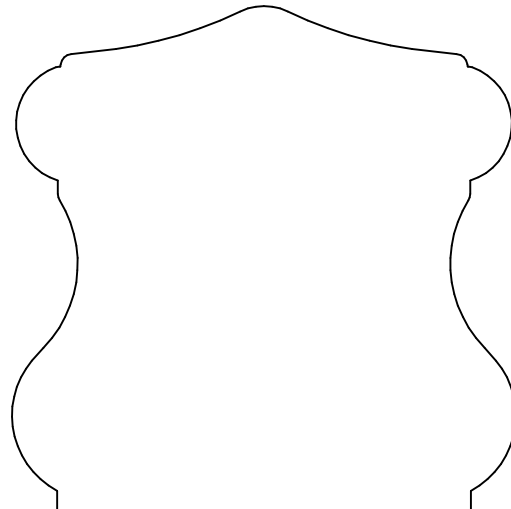

**KL 9956**  
2.625 x 2.625

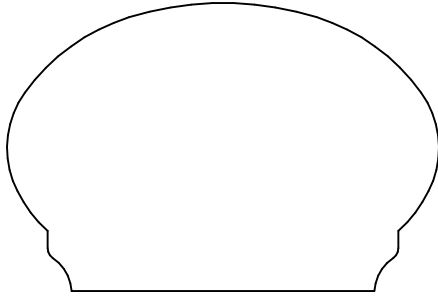

**KL 9957**  
1.500 x 2.250

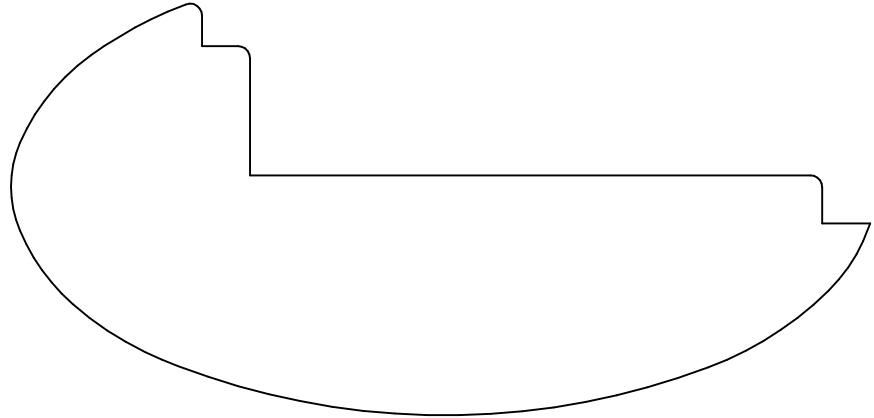

**KL 9958**  
2.140 x 4.475

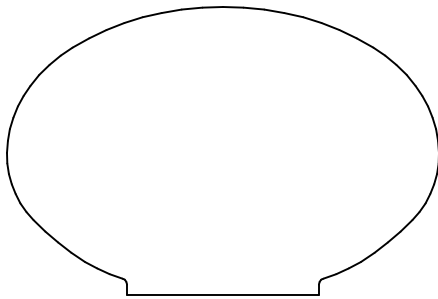

**KL 9959**  
1.500 x 2.250

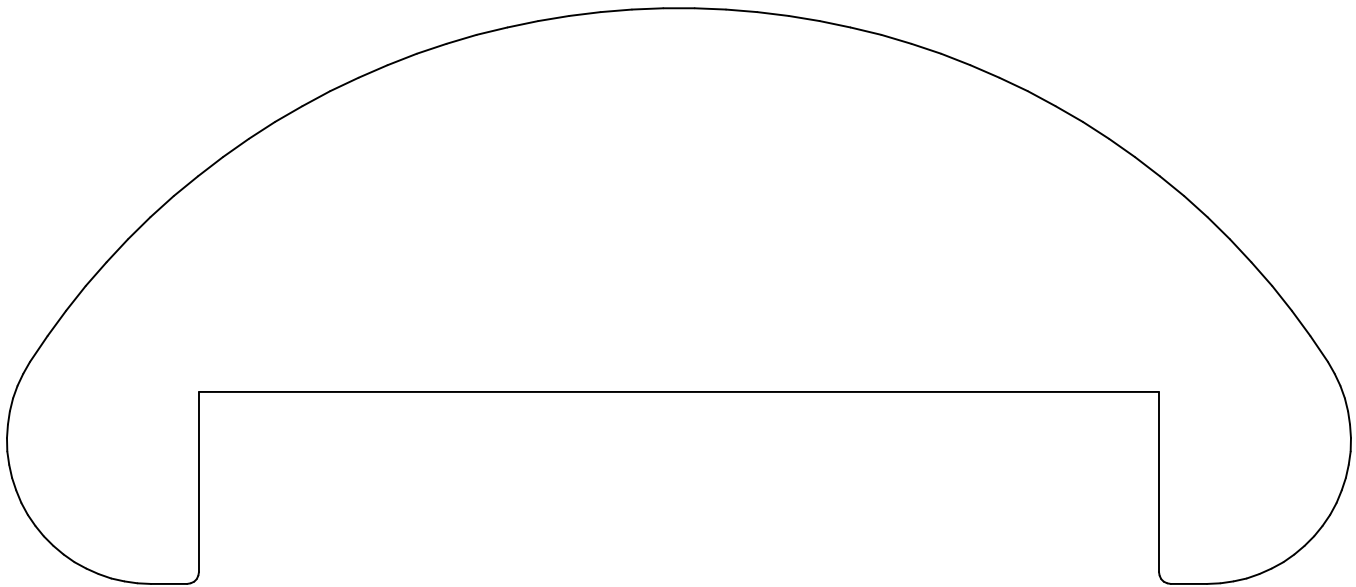

**KL 9960P**  
3.000 x 7.000

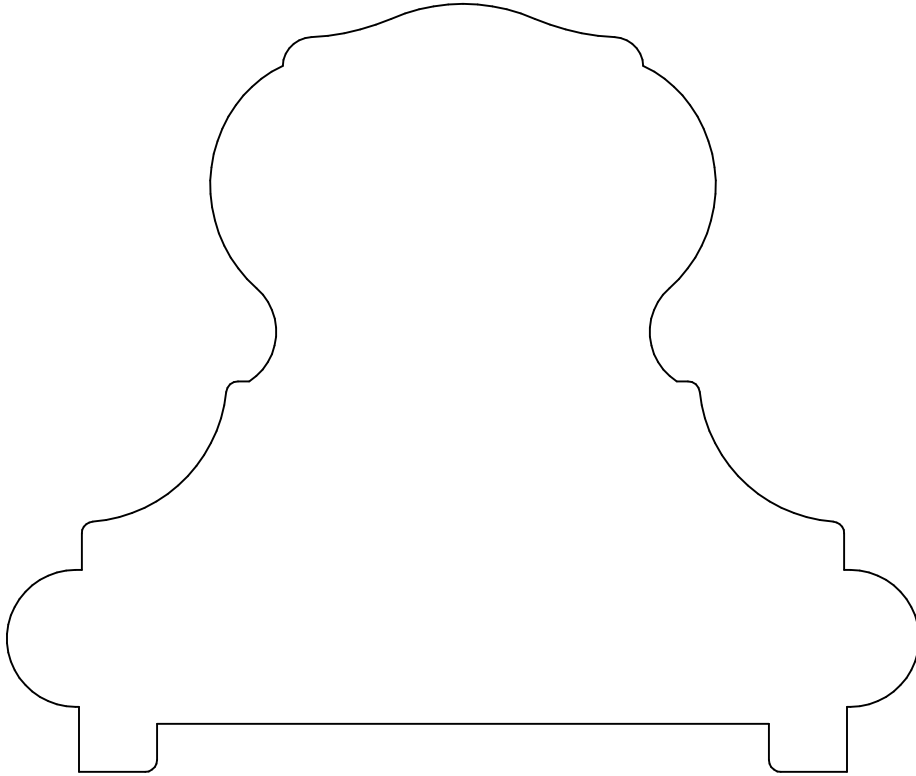

**KL 9961P**  
4.000 x 4.750

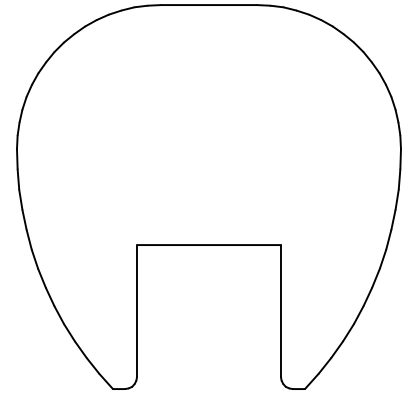

**KL 9968P**  
2.000 x 2.000

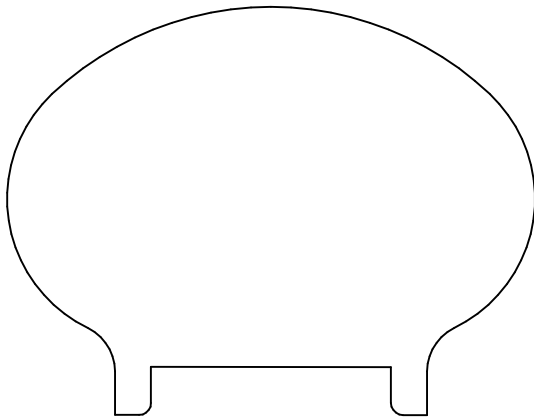

**KL 9962P**  
2.125 x 2.750

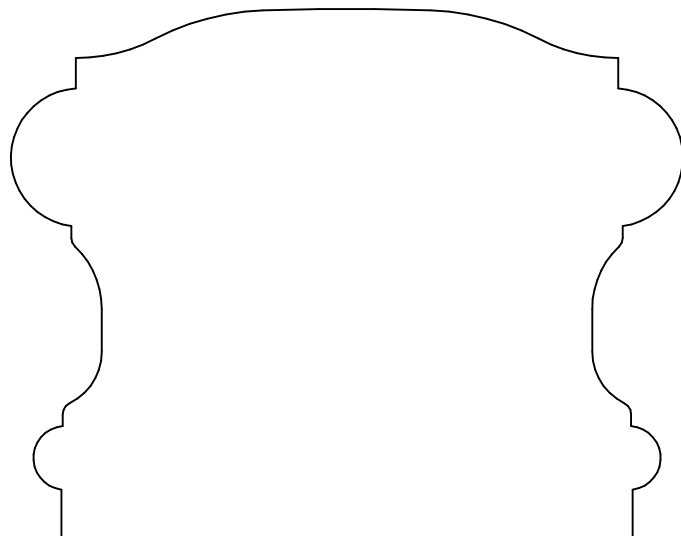

**KL 9963**  
2.750 x 3.500

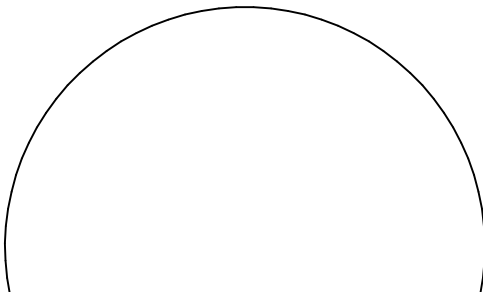

**KL 9974P**  
1.500 x 2.500



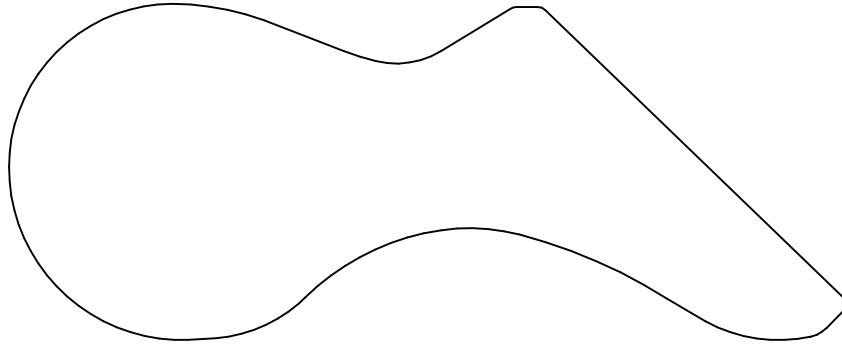

**KL 9964**  
1.750 x 4.380

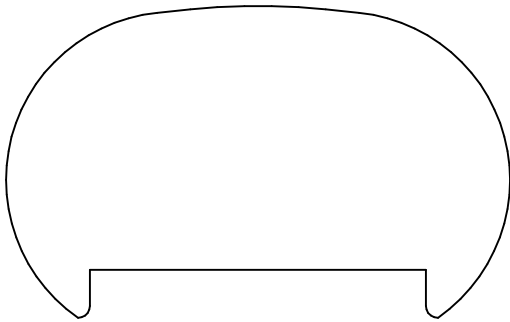

**KL 9965P**  
1.624 x 2.625

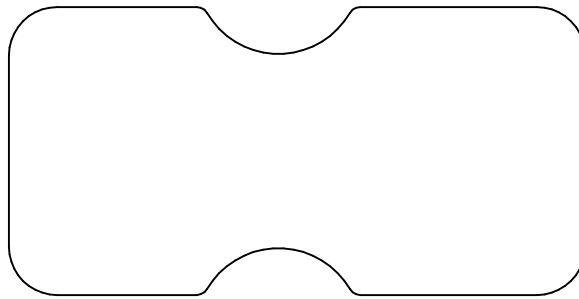

**KL 9976**  
1.500 x 3.000



**KL 9966**  
2.062 x 4.500

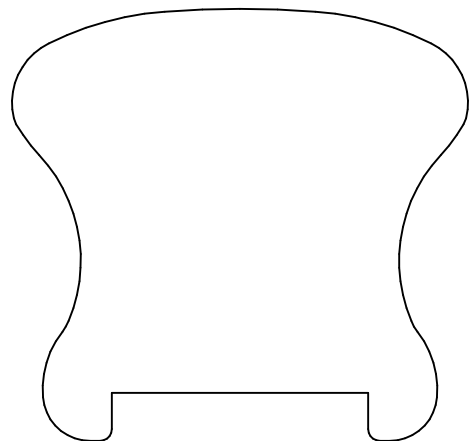

**KL 9977P**  
2.250 x 2.375

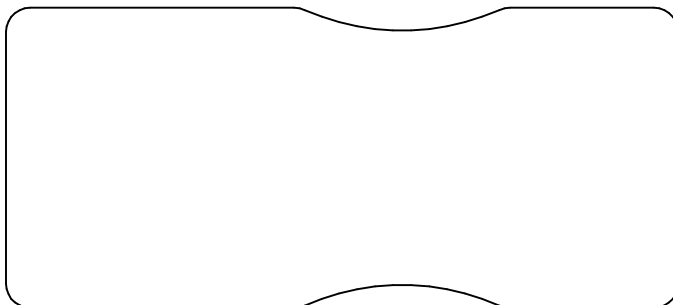

**KL 9984**  
1.563 x 3.500

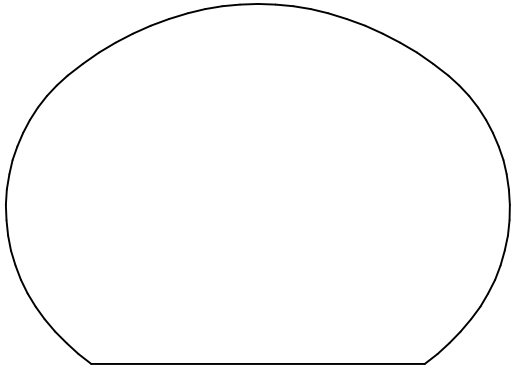

**KL 9967**  
1.875 x 2.625

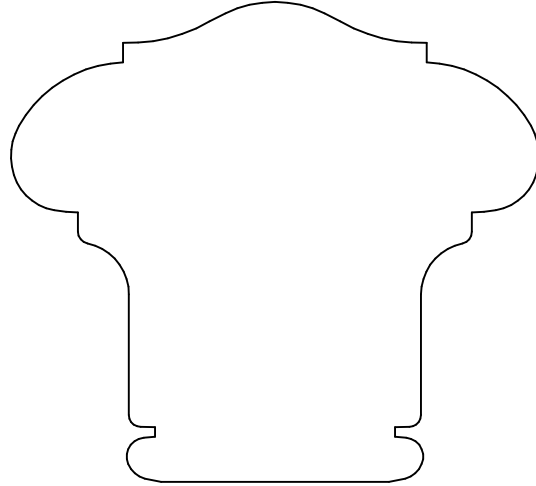

**KL 9970**  
2.500 x 2.750

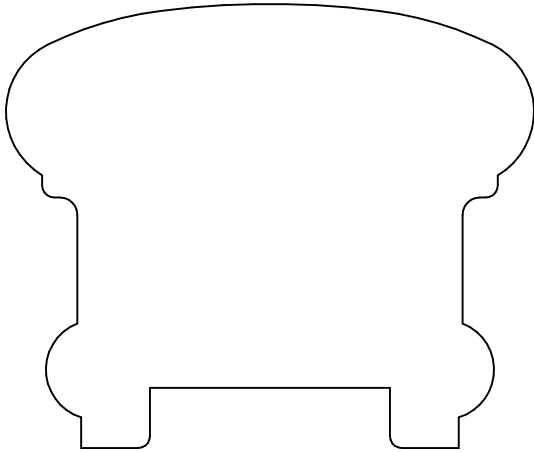

**KL 9971 P**  
2.313 x 2.750

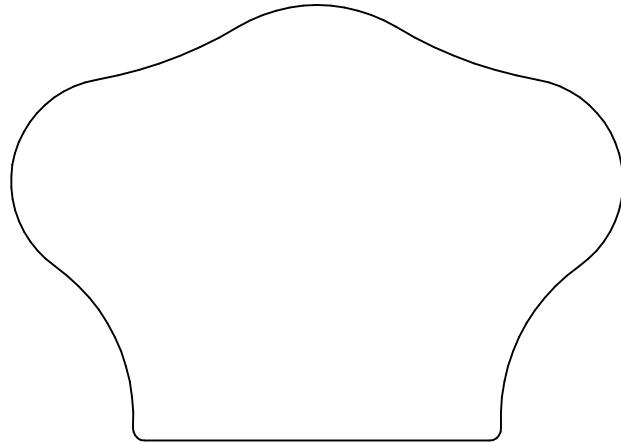

**KL 9972**  
2.269 x 3.188

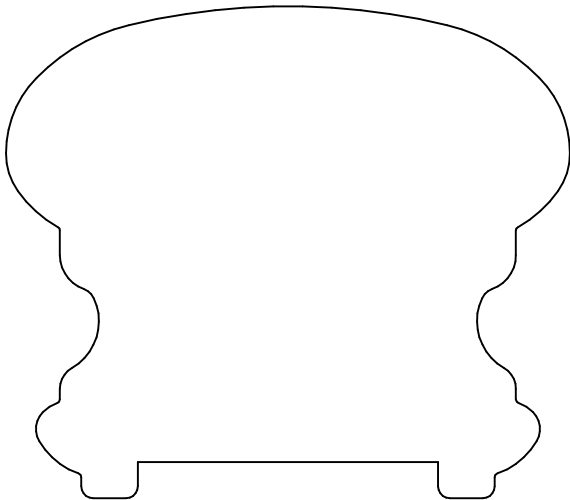

**KL 9973P**  
2.563 x 2.937

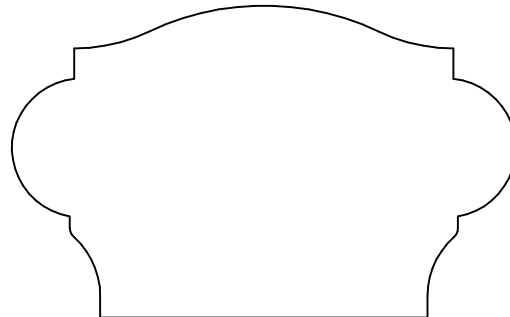

**KL 9978**  
1.625 x 2.625

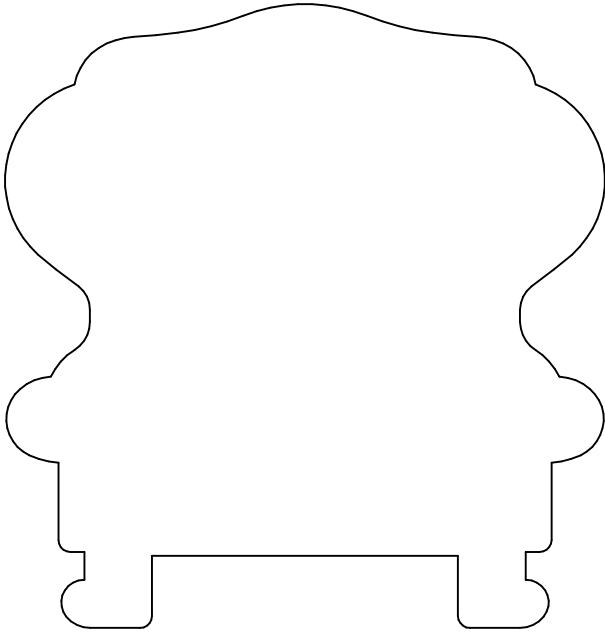

**KL 9975P**  
3.250 x 3.125

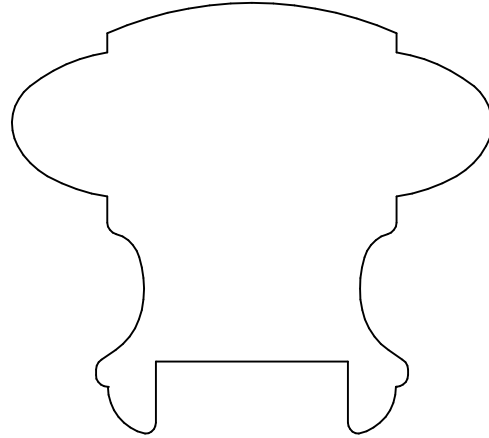

**KL 9979P**  
2.243 x 2.500

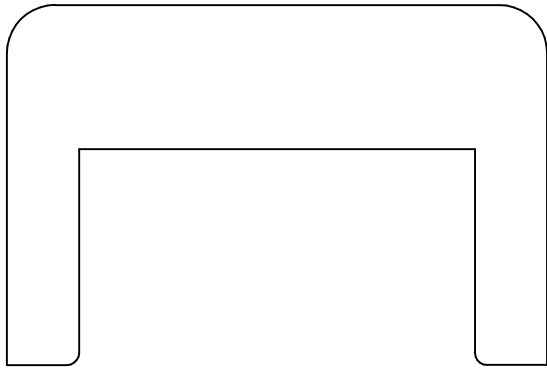

**KL 9980P**  
1.875 x 2.813

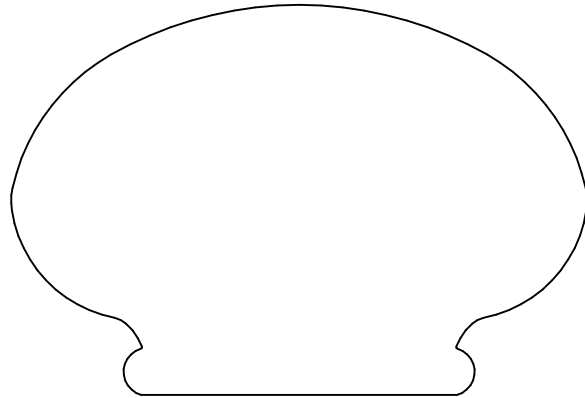

**KL 9981**  
2.031 x 3.000

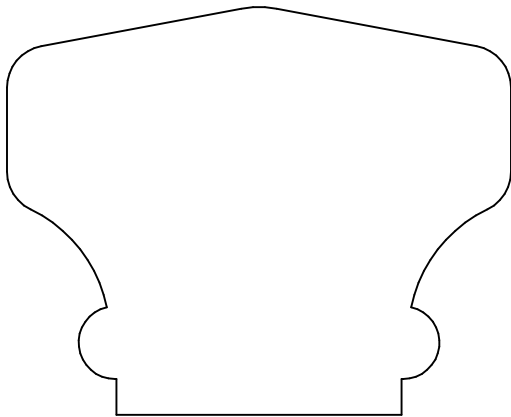

**KL 9982**  
2.125 x 2.625

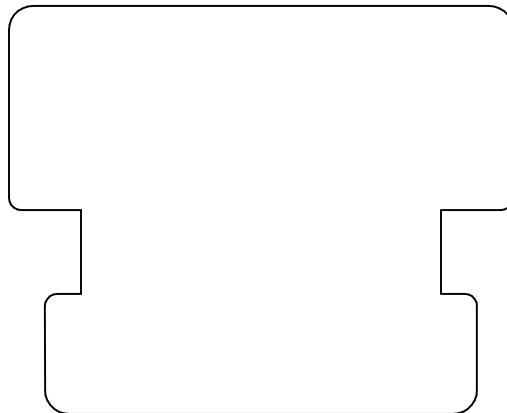

**KL 9989**  
2.125 x 2.625

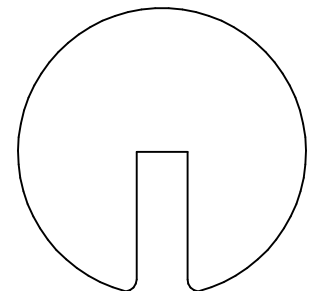

**KL 9990 P**  
1.476 x 1.500

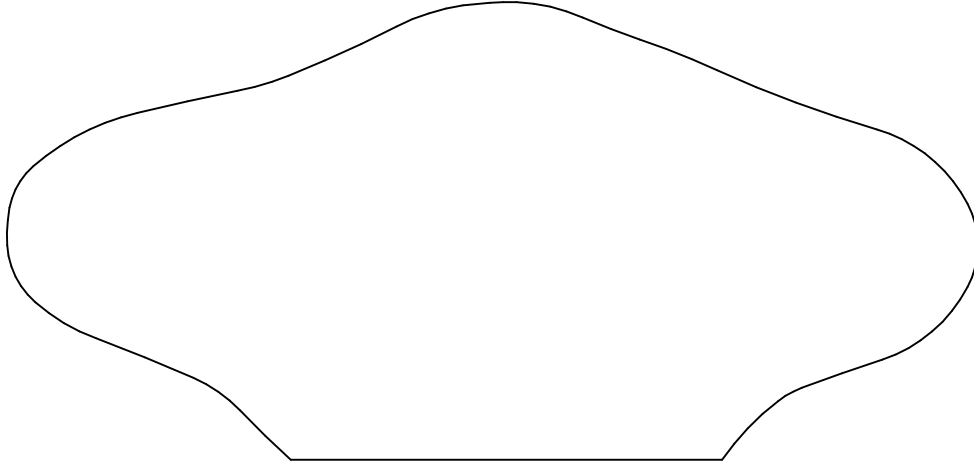

**KL 9983**  
2.385 x 5.056

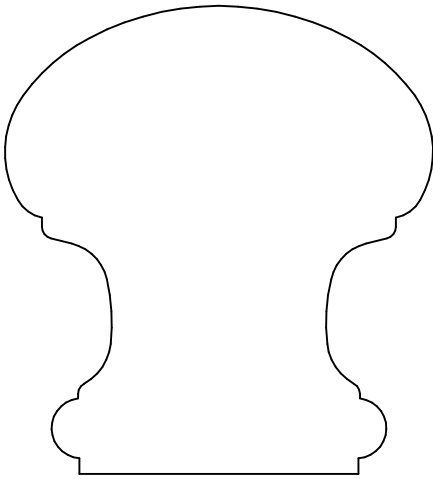

**KL 9986**  
2.438 x 2.229

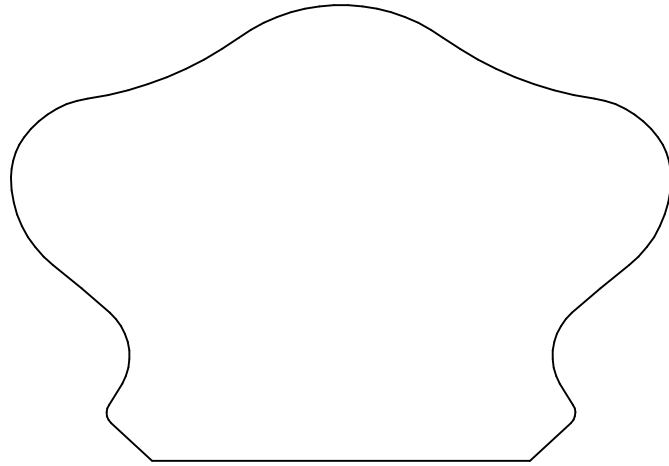

**KL 9987**  
2.375 x 3.438

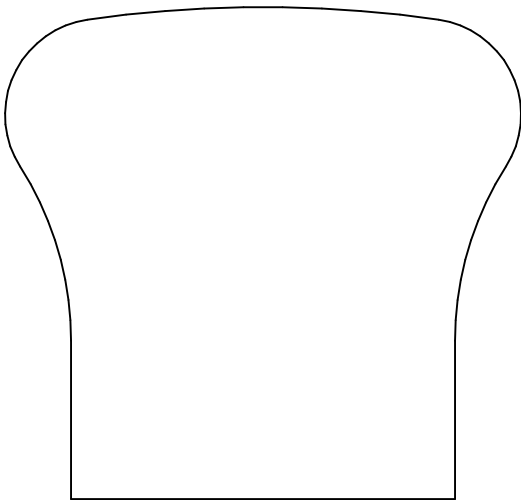

**KL 9988**  
2.563 x 2.688

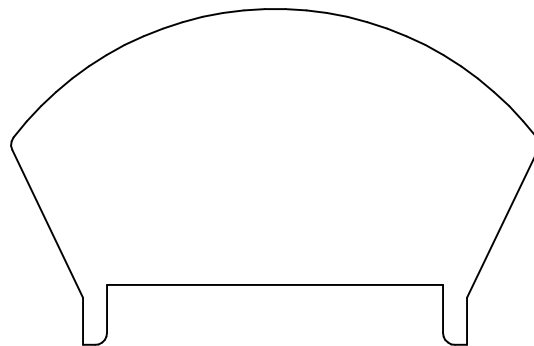

**KL 9991P**  
1.750 x 2.750

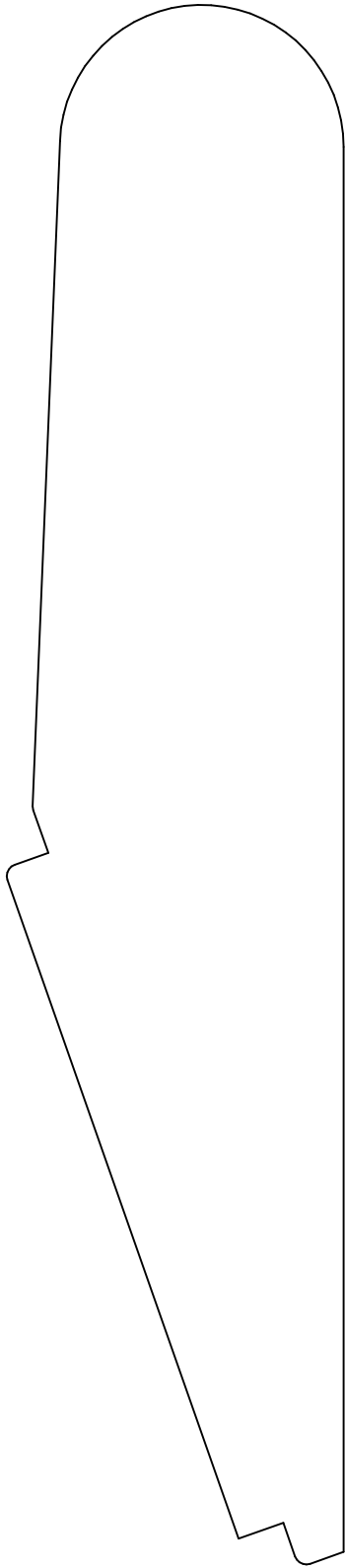

**KL 9985**  
1.779 x 8.236

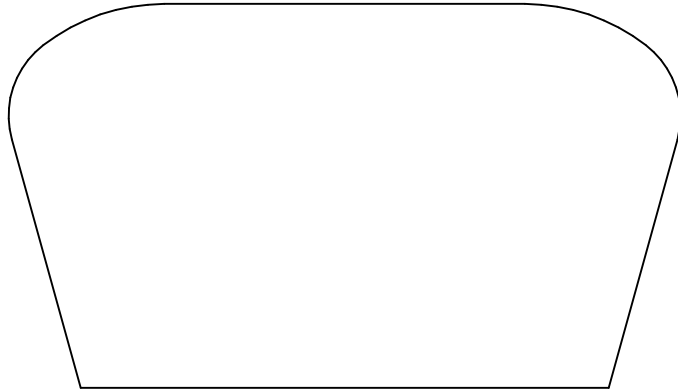

**KL 9992**  
2.000 x 3.500

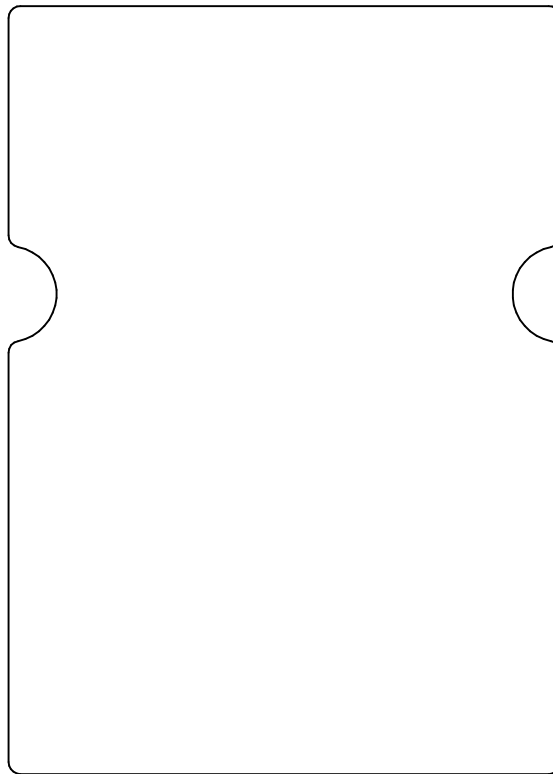

**KL 9993**  
4.000 x 2.875

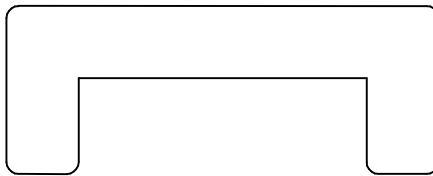

**KL 9998P**  
.875 x 2.250

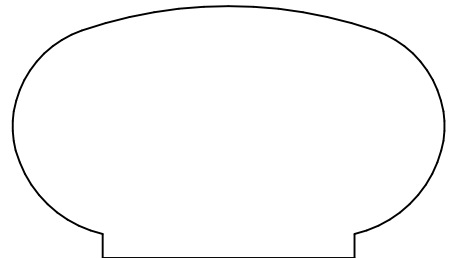

**KL 11907**  
1.313 x 2.250

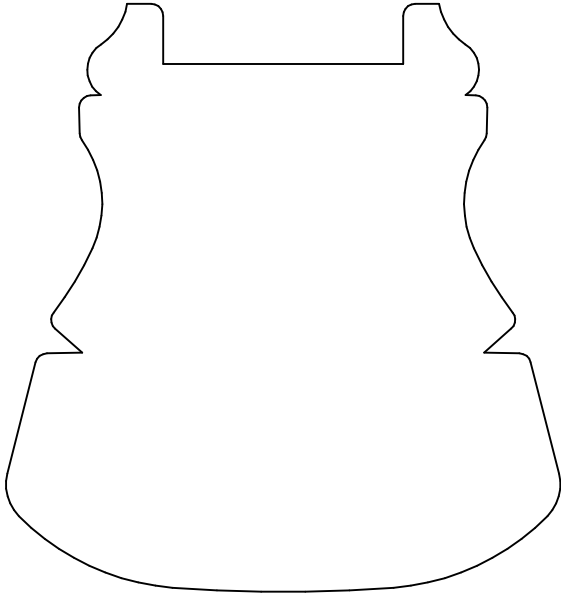

**KL 9995P**  
3.063 x 2.887

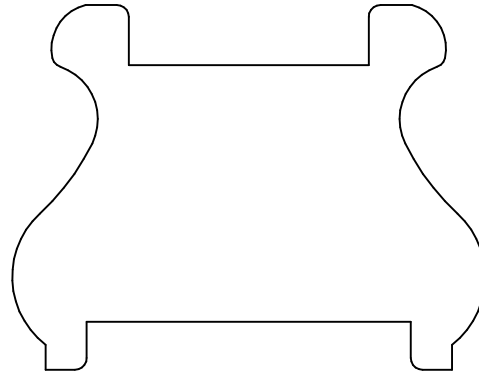

**KL 9996P**  
1.900 x 2.463

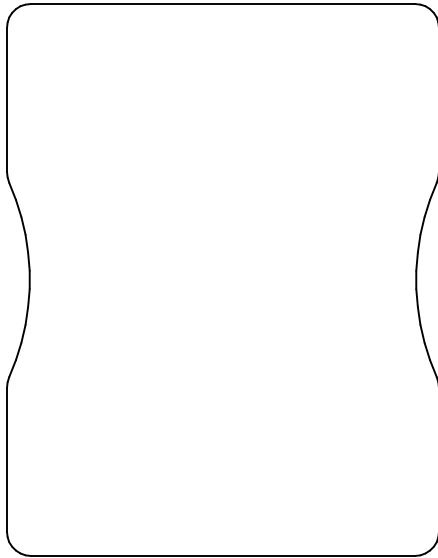

**KL 9997**  
2.875 x 2.250

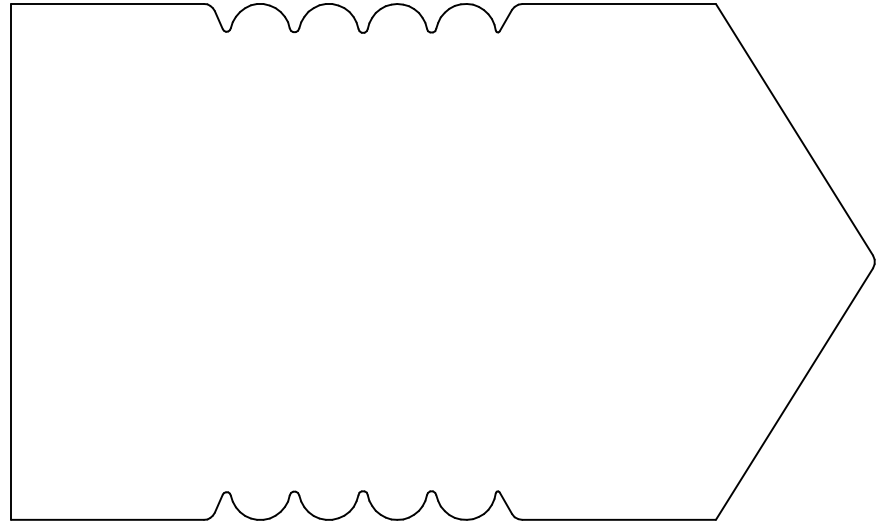

**KL 11900**  
2.688 x 4.500

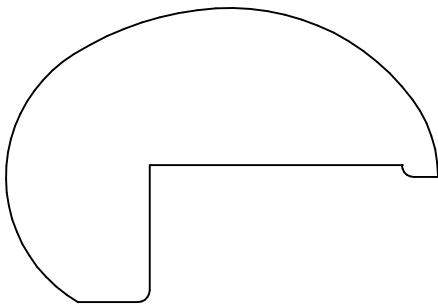

**KL 11910**  
1.532 x 2.250

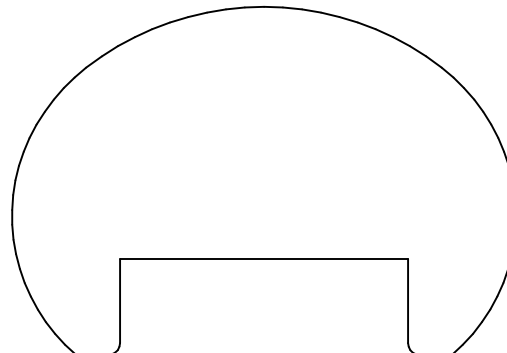

**KL 11903P**  
1.812 x 2.625

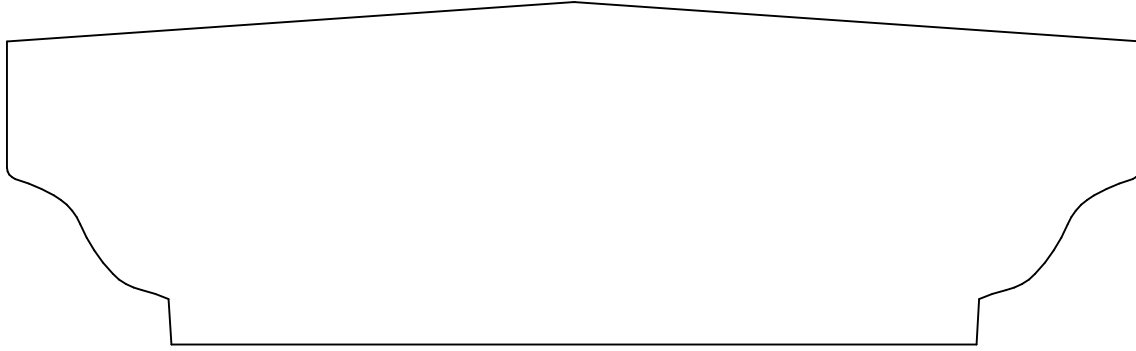

**KL 9999**  
1.784 x 5.906

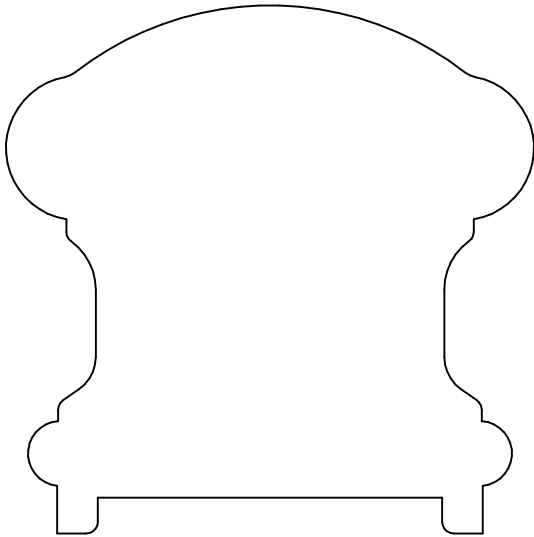

**KL 11901P**  
2.750 x 2.750

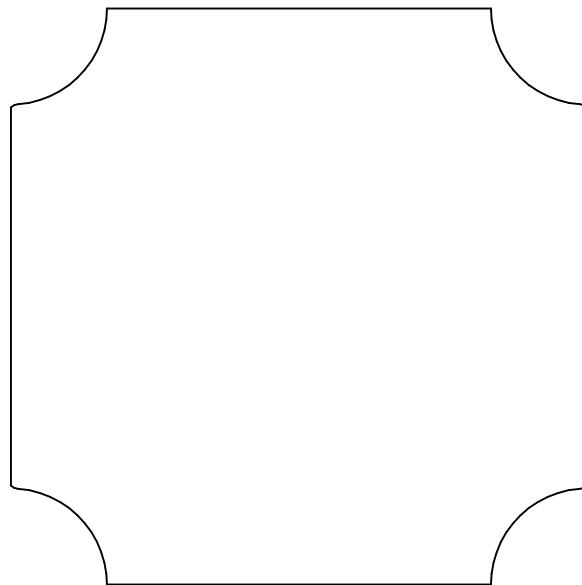

**KL 11902**  
3.000 x 3.000



**KL 11904**  
1.750 x 5.500

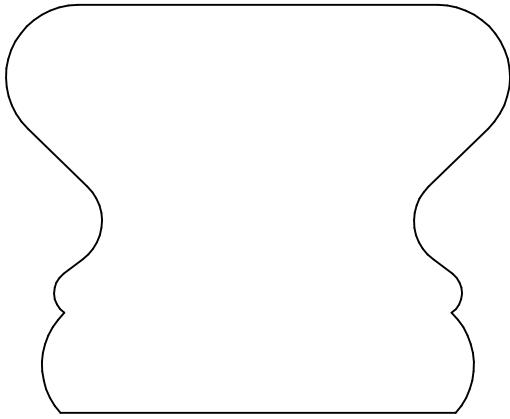

**KL 11905**  
2.125 x 2.625

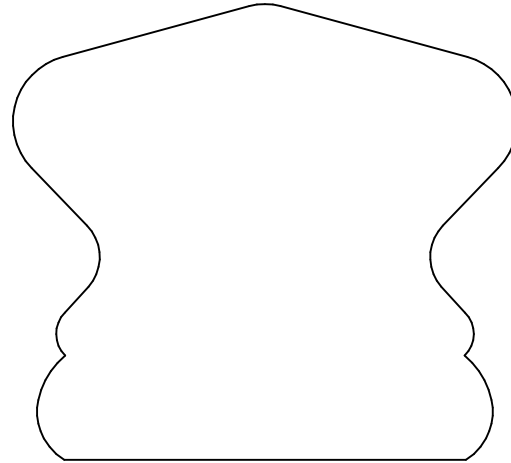

**KL 11906**  
2.375 x 2.625

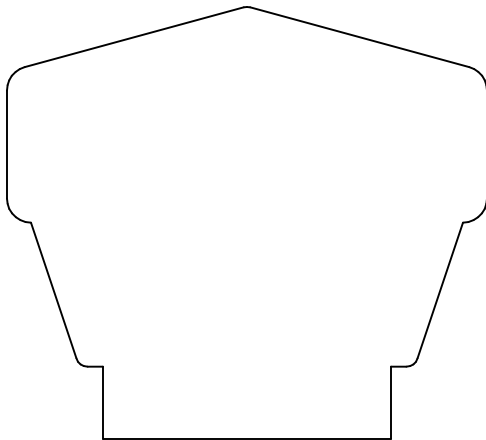

**KL 11908**  
2.250 x 2.500

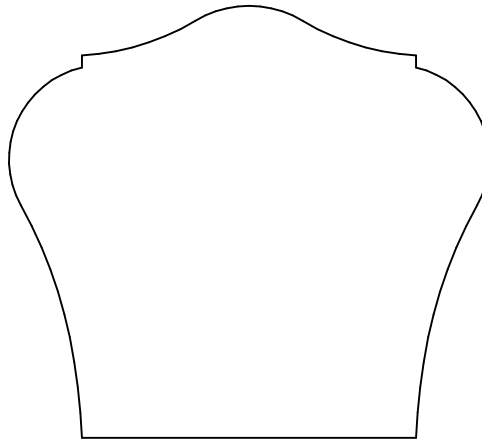

**KL 11909**  
2.250 x 2.500

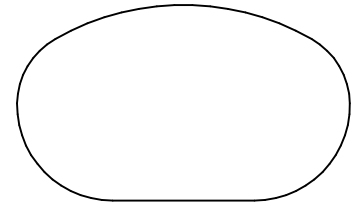

**KL 11927**  
1.019 x 1.734

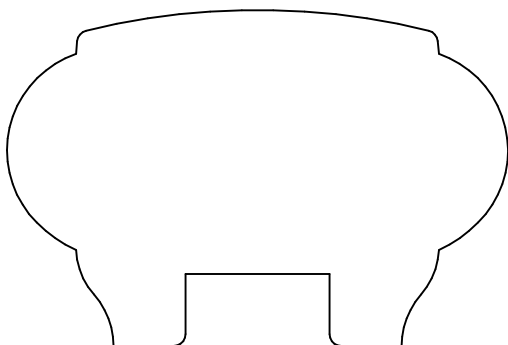

**KL 11912P**  
1.750 x 2.609

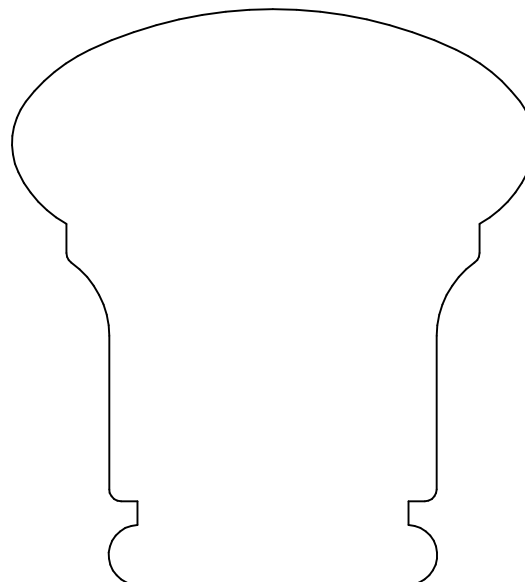

**KL 11913**  
3.000 x 2.719



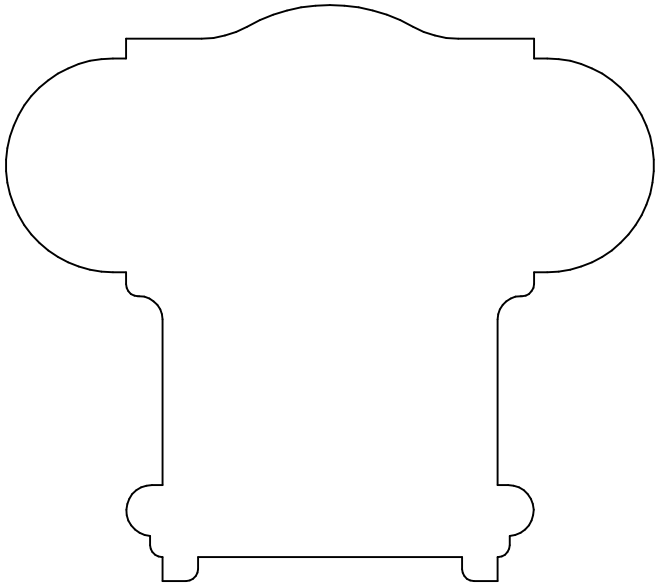

**KL 11914 P**  
3.000 x 3.375

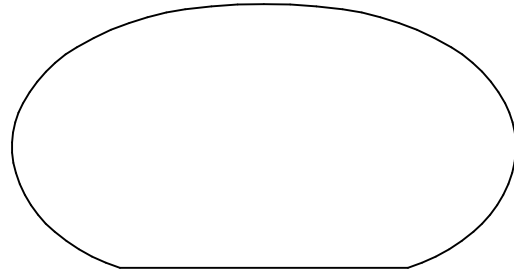

**KL 11915**  
1.375 x 2.625

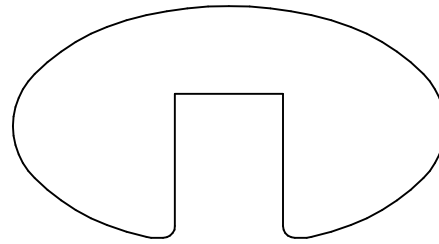

**KL 11916 P**  
1.208 x 2.250

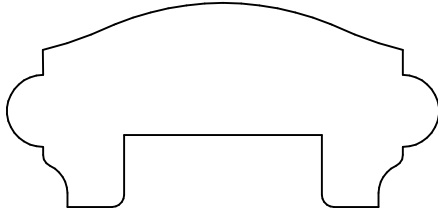

**KL 11917 P**  
1.063 x 2.250

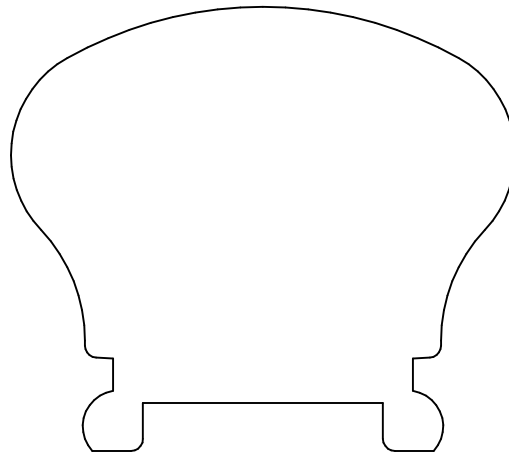

**KL 11918 P**  
2.312 x 2.625

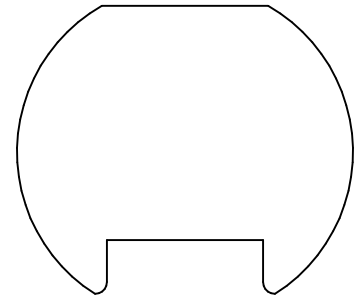

**KL 11930 P**  
1.500 x 1.750



**KL 11931 P**  
1.250 x 2.750

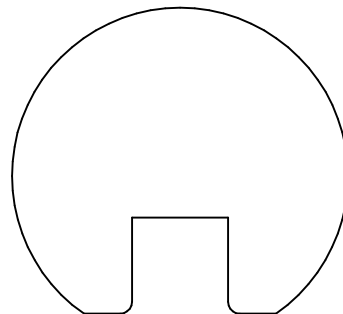

**KL 11932 P**  
1.593 x 1.750

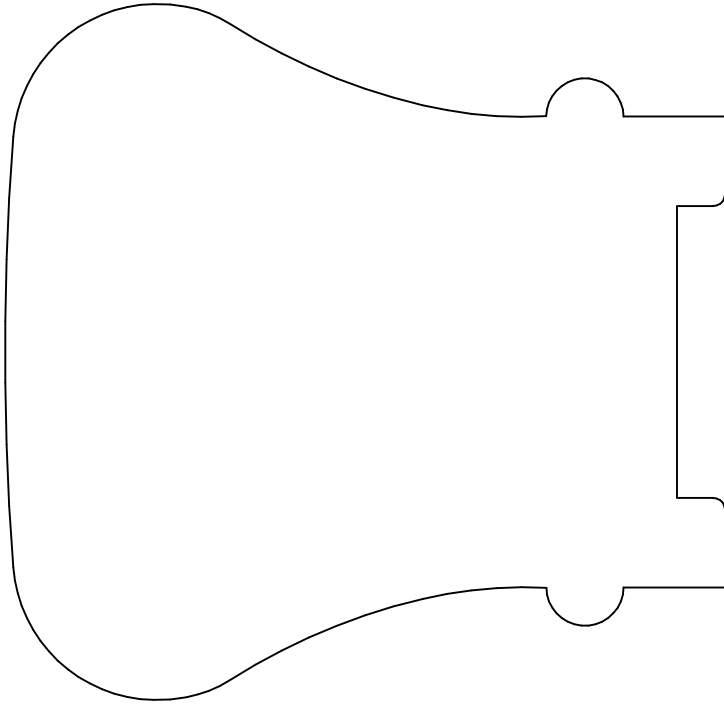

**KL 11919P**  
3.625 x 3.750

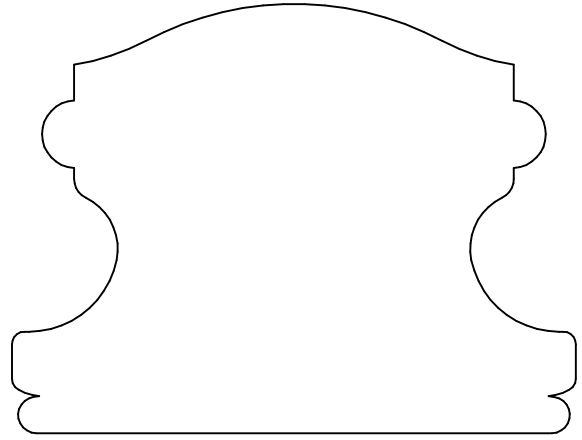

**KL 11923**  
2.235 x 2.938

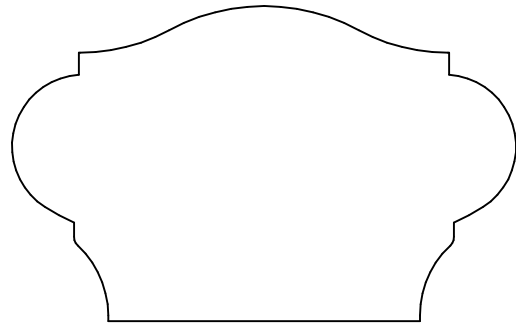

**KL 11924**  
1.640 x 2.625

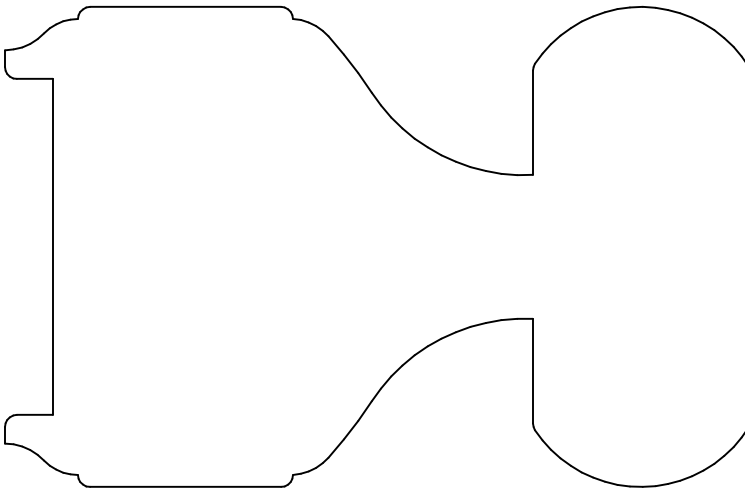

**KL 11921 P**  
2.500 x 3.875

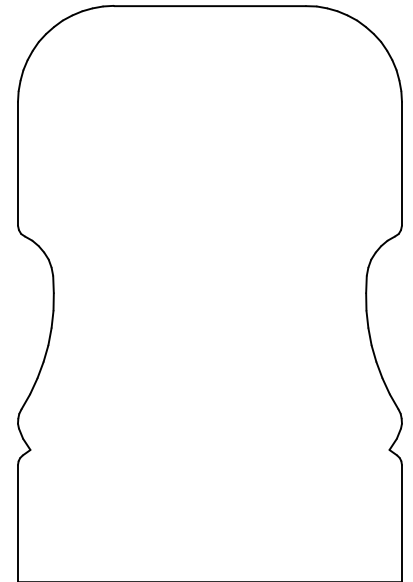

**KL 11935**  
3.000 x 2.000

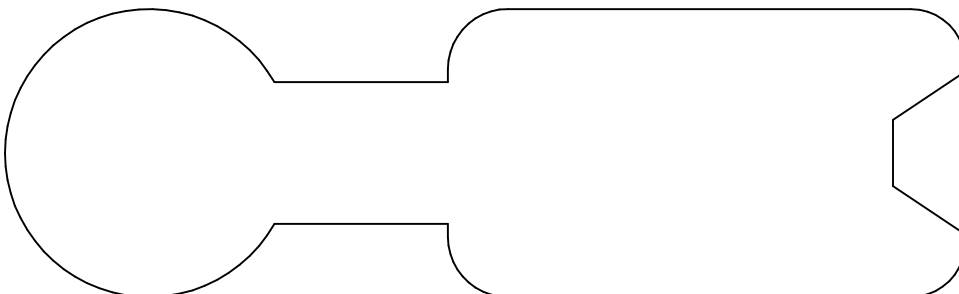

**KL 11925P**  
1.500 x 5.000

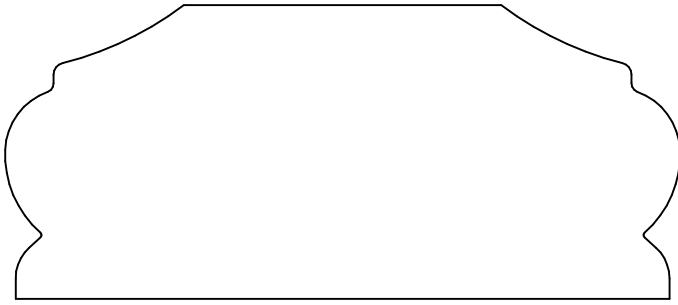

**KL 11922**  
1.531 x 3.516

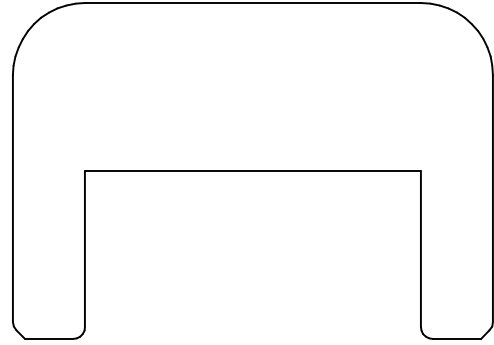

**KL 11926P**  
1.750 x 2.500

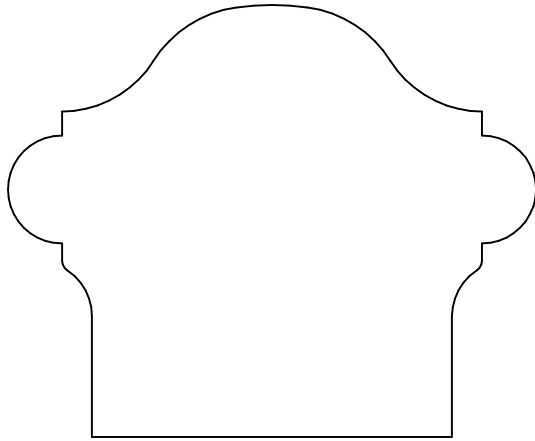

**KL 11928**  
2.250 x 2.750

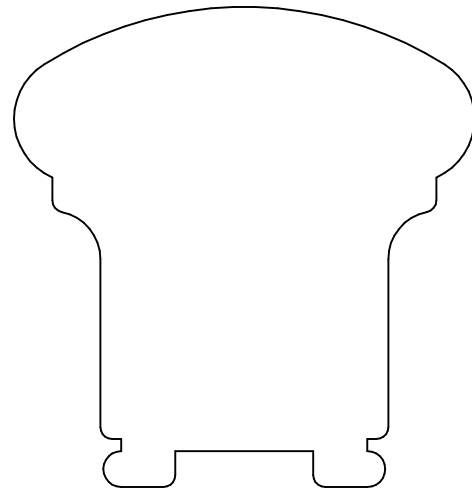

**KL 11933 P**  
2.500 x 2.399

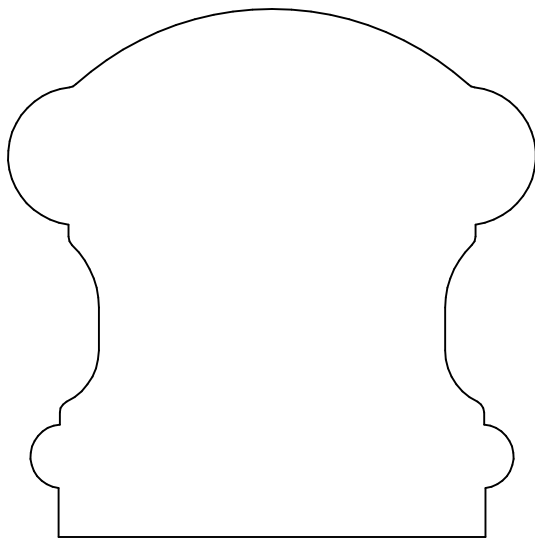

**KL 11934**  
2.750 x 2.750

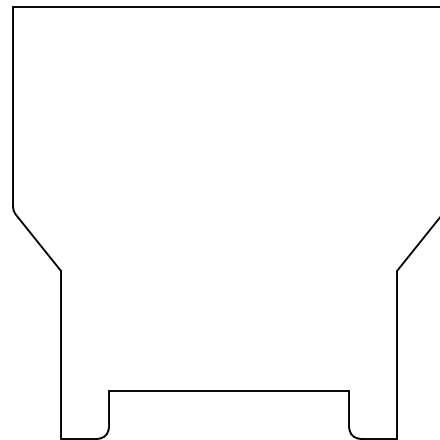

**KL 11936P**  
2.250 x 2.250

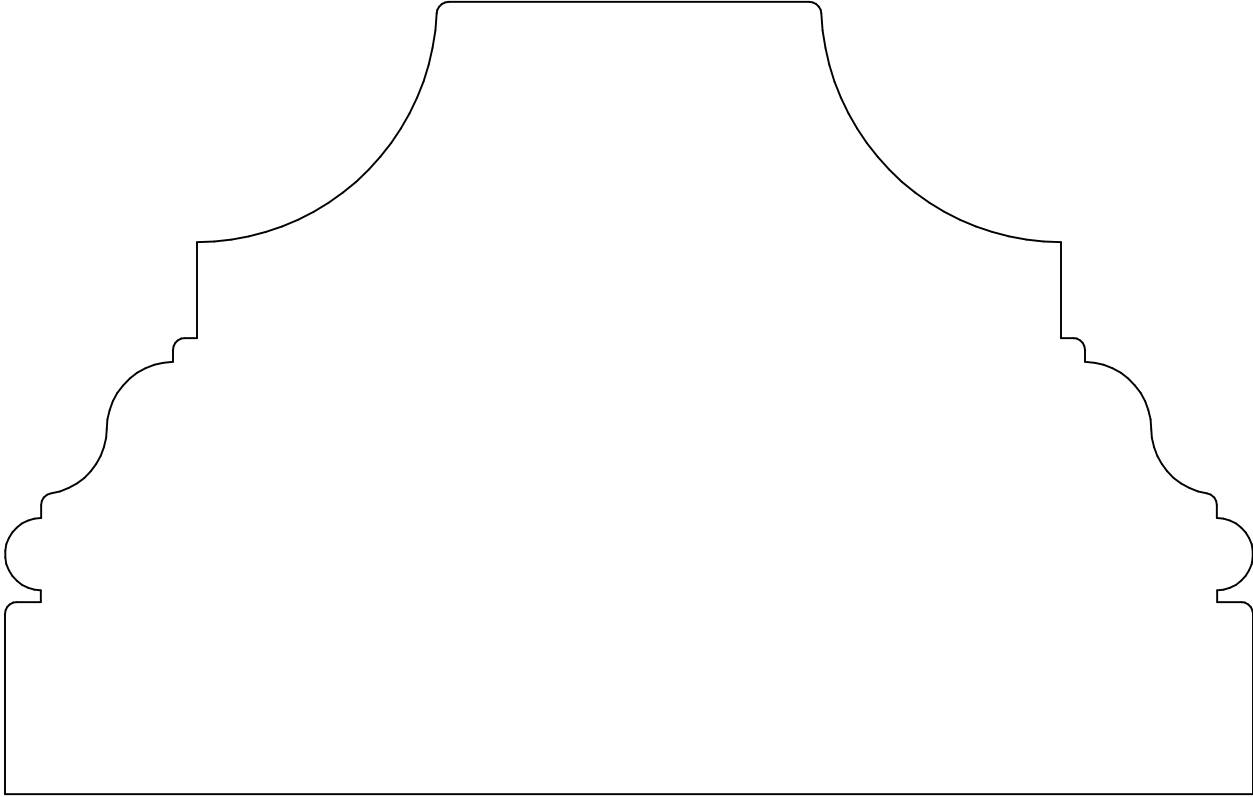

**KL 11929**  
4.125 x 6.500

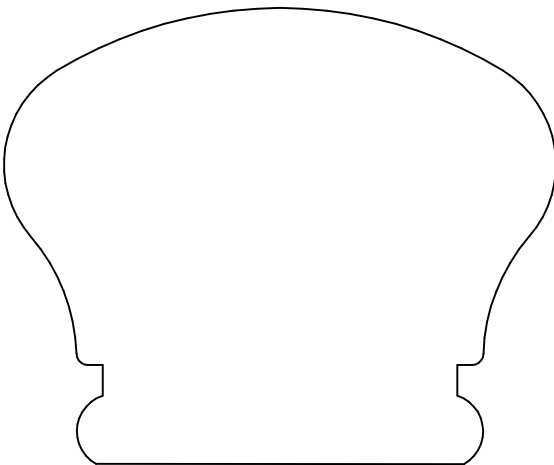

**KL 11937**  
2.375 x 2.875

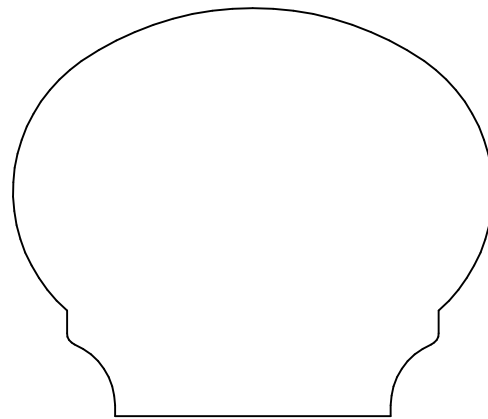

**KL 11939**  
2.125 x 2.499



**KL 11948 P**  
.813 x 3.000

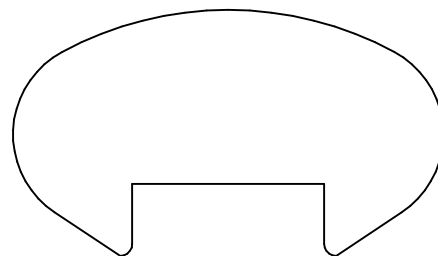

**KL 11954 P**  
1.280 x 2.242

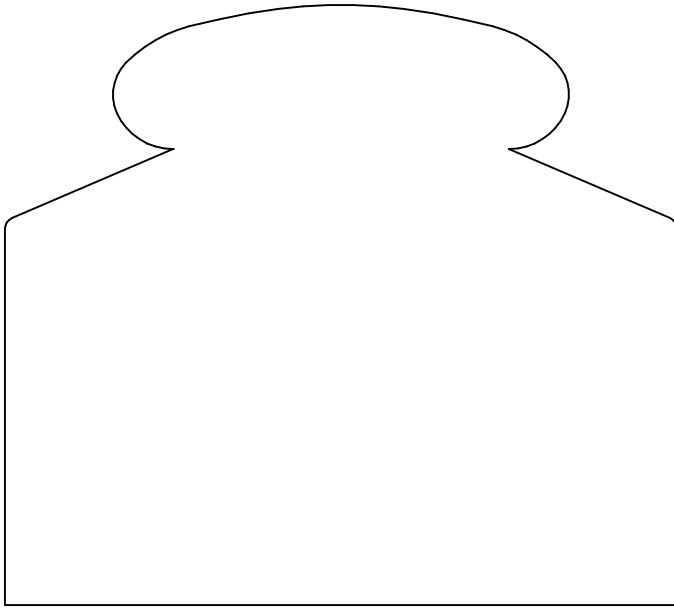

**KL 11941**  
3.125 x 3.500

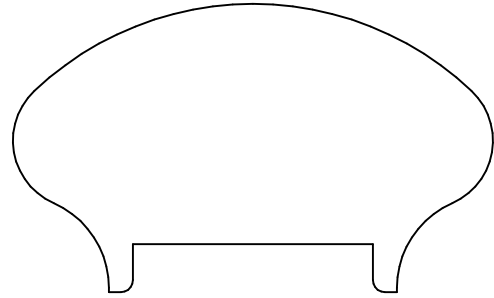

**KL 11942 P**  
1.500 x 2.500

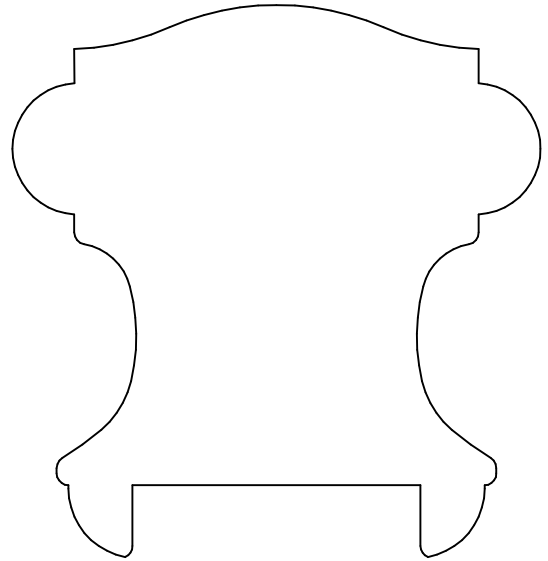

**KL 11946 P**  
2.875 x 2.750

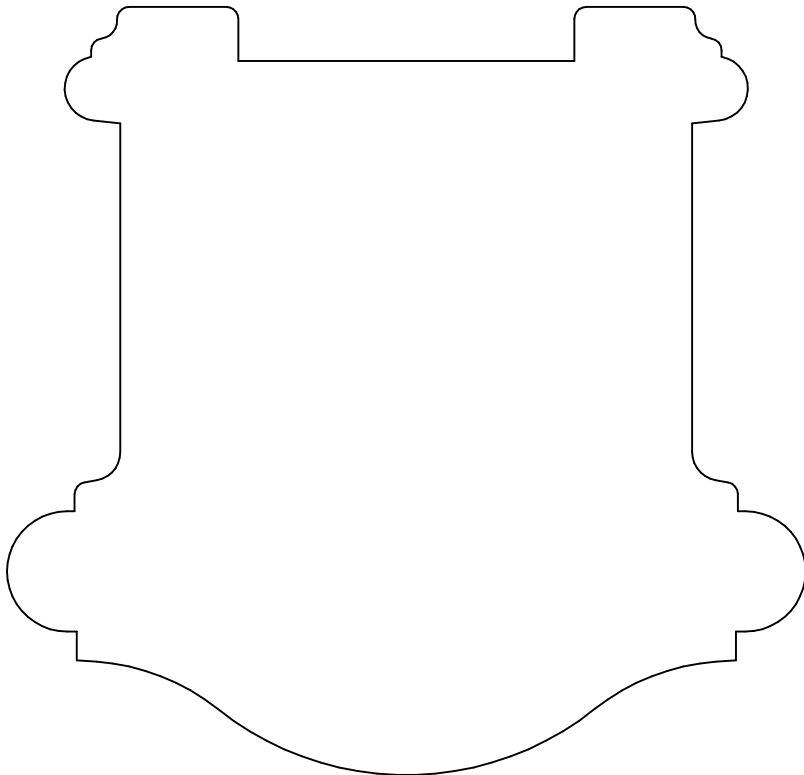

**KL 11944 P**  
4.000 x 4.159

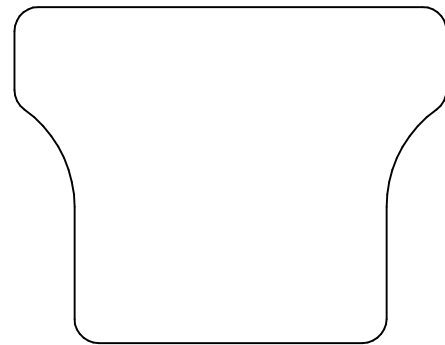

**KL 11950**  
1.750 x 2.250

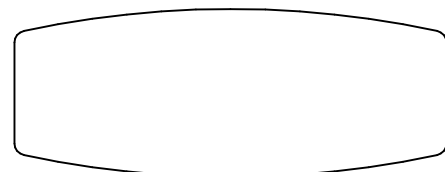

**KL 11971**  
.875 x 2.250

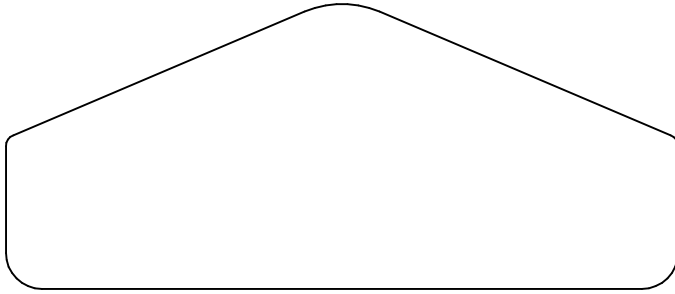

**KL 11945**  
1.484 x 3.500

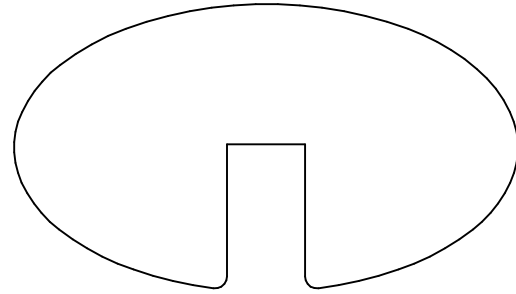

**KL 11963 P**  
1.481 x 2.625

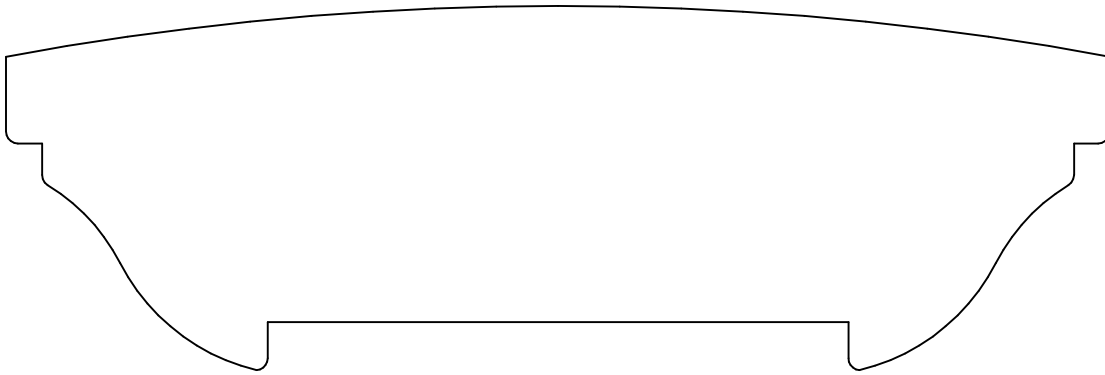

**KL 11947 P**  
1.897 x 5.750

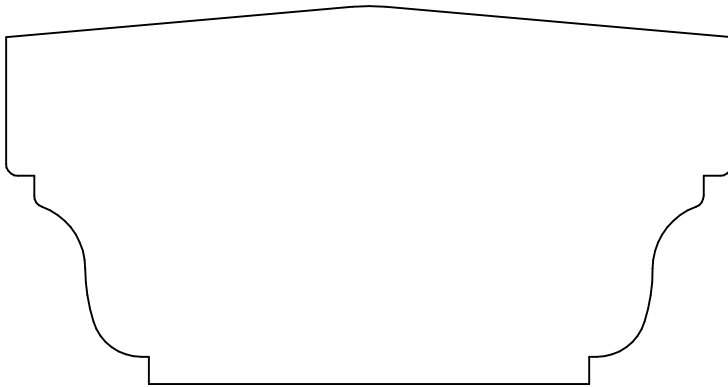

**KL 11949**  
1.969 x 3.781

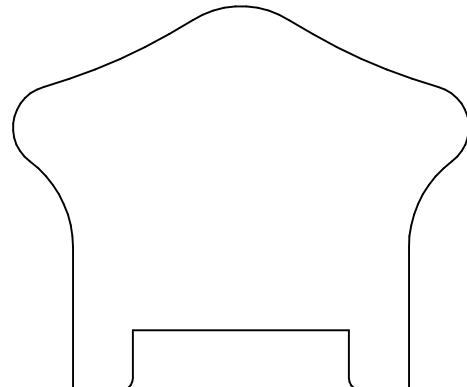

**KL 11951 P**  
2.000 x 2.375



**KL 11965**  
1.250 x 3.000

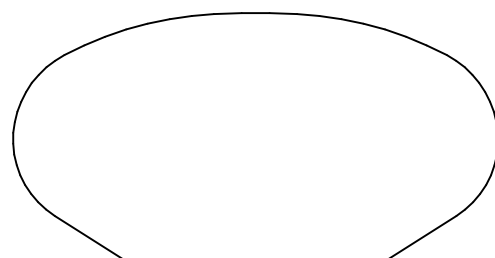

**KL 11968**  
1.281 x 2.527

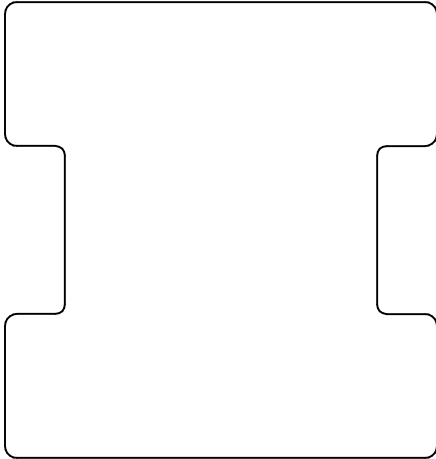

**KL 11952**  
2.375 x 2.250

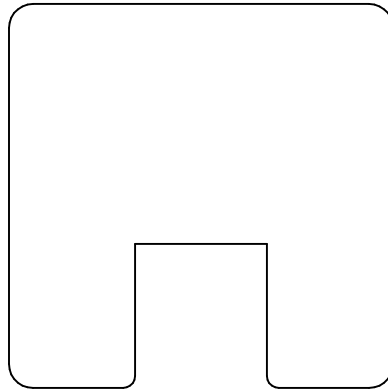

**KL 11953 P**  
2.000 x 2.000

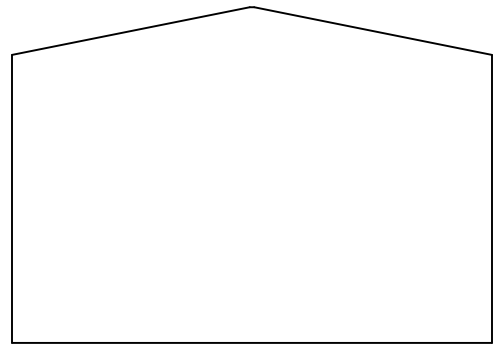

**KL 11961**  
1.750 x 2.500

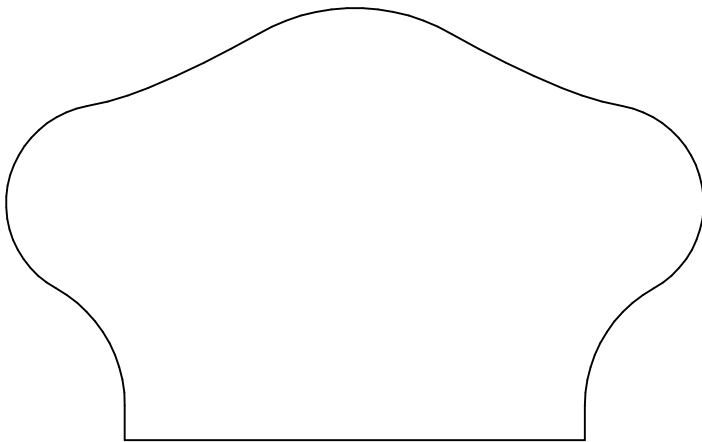

**KL 11956**  
2.250 x 3.634

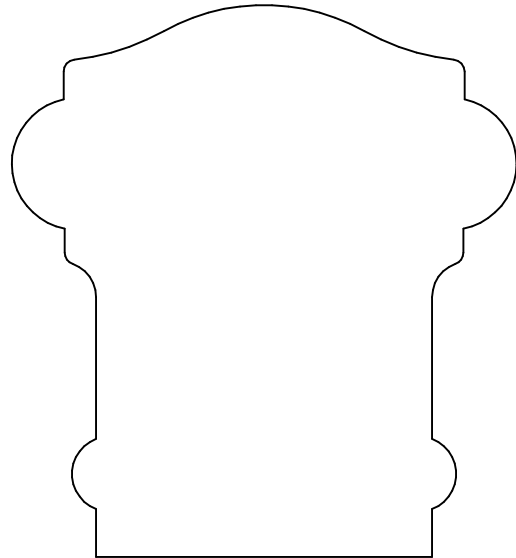

**KL 11958**  
2.875 x 2.629

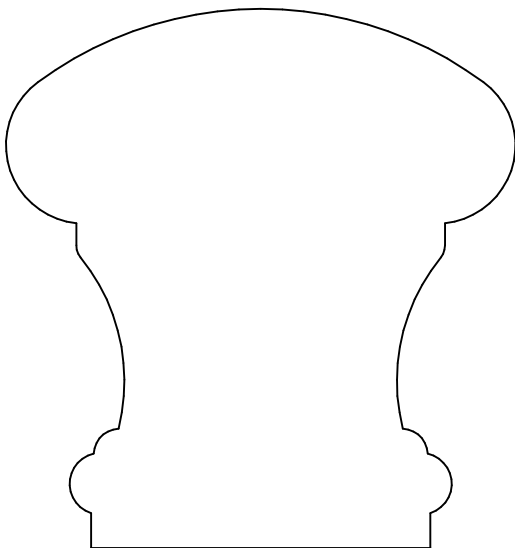

**KL 11966**  
2.808 x 2.653

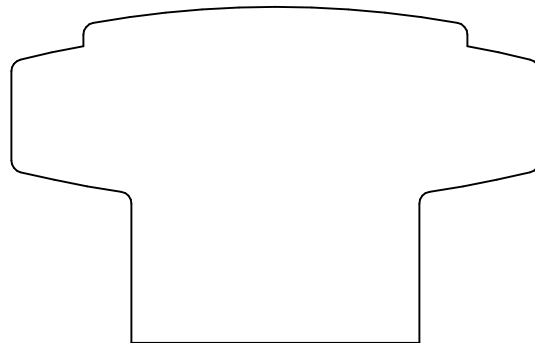

**KL 11967**  
1.750 x 2.750

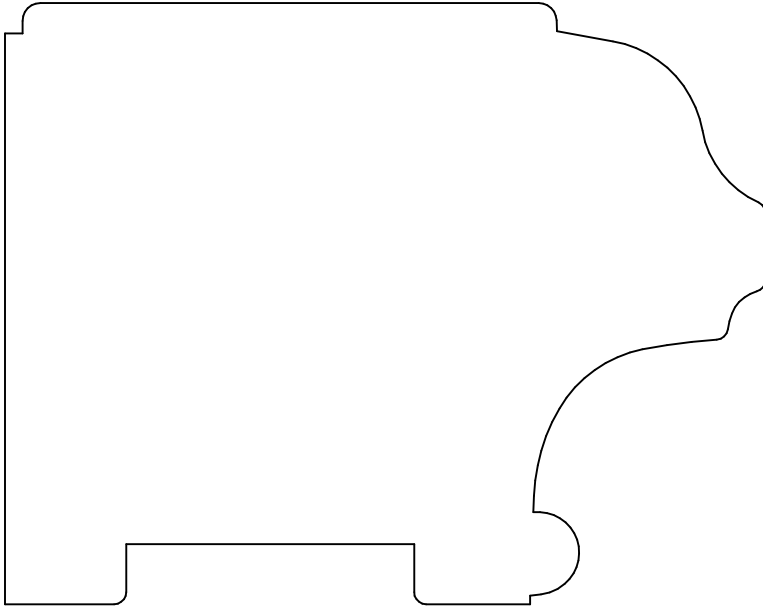

**KL 11960 P**  
3.131 x 3.961

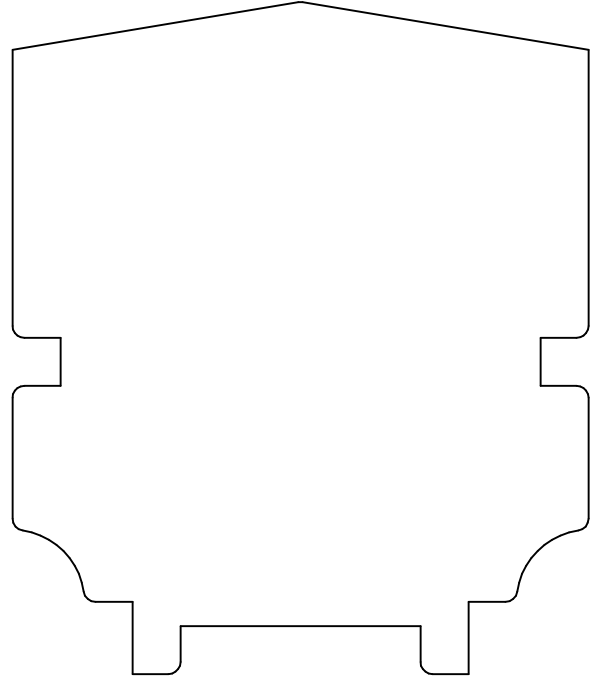

**KL 11962 P**  
3.500 x 3.000

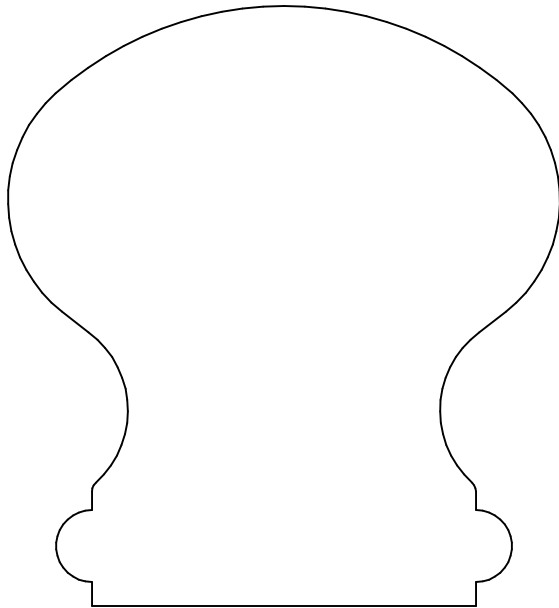

**KL 11964**  
3.125 x 2.875

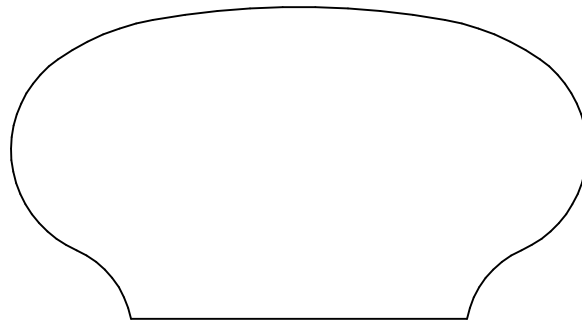

**KL 11969**  
1.625 x 3.000

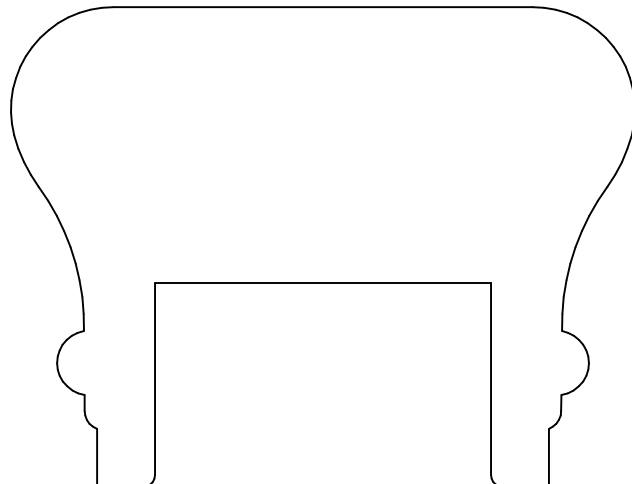

**KL 11970P**  
2.500 x 3.250



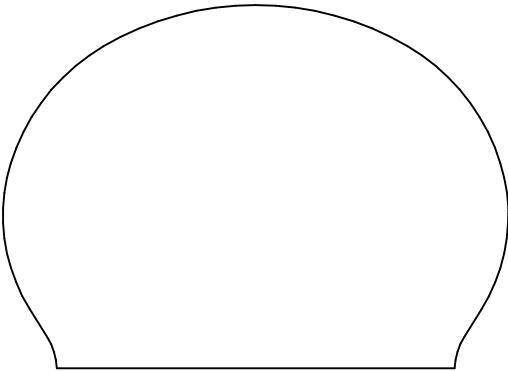

KL 11972  
1.893 x 2.632