

# Elegant-Rise Stair Systems

KEIM STAIR CATALOG



**Keim**

BUILT ON TRUST, SINCE 1911

4465 SR 557 | CHARM, OH 44617 | 330.893.2251 | [WWW.KEIMHOME.COM](http://WWW.KEIMHOME.COM)

# Keim

4465 SR 557 | PO Box 6

Charm, OH 44617

Phone: 330.893.2251

Toll Free: 800.362.6682

Fax: 330.893.3325

[www.keimhome.com](http://www.keimhome.com)

## HOURS

Monday 7am - 7pm

Tue.-Fri. 7am - 4:30pm

Sat. 7:30am - Noon

## HOME CENTER

Home Owners

Do-it-yourself

Hobbyists

125,000 Sq. Ft. Showroom

## MILLWORK SPECIALTY

Wholesale Manufacturers

Architectural Millwork

In-Stock Trim & Doors

Direct Line: 866.872.0500

Fax: 330.893.7039

## WOODSHOP SUPPLY

Servicing Professional

Cabinet & Furniture Shops

Direct Line: 330.893.5055

Toll Free: 866.542.5205

## CONTRACTOR SALES

Serving Builders

Contractors

New Home Sales

Drafting Services

Direct Line: 330.893.5065



## Quality Stairs

## Contents

1 3/4" Balusters . . . . .	4-21
1 1/4" Balusters . . . . .	22-27
Contemporary . . . . .	28
Box Newel . . . . .	29
Steps & Fittings . . . . .	30-33
Accessories . . . . .	34
Custom . . . . .	35
Hardware & Tools . . . . .	36-37
Planning & Guidelines . . . . .	38-39



"Add long-lasting beauty  
and value to your home."

Quality, Service, Integrity.

# KEIM IS PLEASED TO OFFER THE Elegant-Rise

## BALUSTER SYSTEM



OVER THE POST  
STAIR SYSTEM



POST TO POST  
STAIR SYSTEM  
WITH FITTINGS



POST TO POST  
STAIR SYSTEM  
WITHOUT FITTINGS

Keim offers the ELEGANT-RISE Stair system in 11 rail profiles, with 12 baluster/newel designs in 5 profiles and two diameters. These stair parts can be combined in one of three different layouts: over the post, post to post with fittings, or post to post without fittings.



Keim offers open or closed tread designs with bull nose or square cut starting steps. You can choose either full wood tread or false end treads (to be used with a carpet runner). Parts are available in Oak, Poplar, Cherry, Maple, or a number of other species, both domestic and exotic, as well as Prefinished White.

Whatever your stair design, Keim will provide quality stair parts from stock, the factory, or our custom mill. You'll be glad you used Keim's Elegant-Rise stair system.

This system provides a graceful rise of the balusters as they ascend the stairway.

The lower blocks of the balusters follow the rise of the stairs, offering an Elegant Clean look.



CLOSED STAIR SYSTEM



OPEN STAIR SYSTEM WITH  
CUSTOM STARTING STEP

# Hand Rail

STANDARD OR CONECT-A-KIT™ FITTINGS AVAILABLE

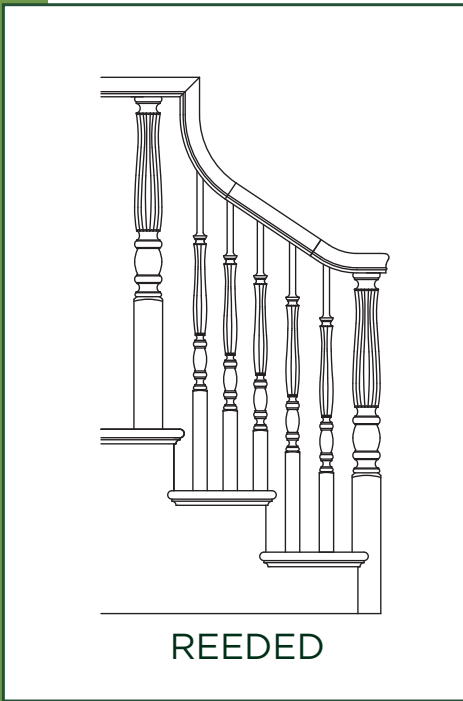

1 3/4" Balusters

KLS6109



KLS6109P1  
2 7/8" x 2 3/8"

KLS6210

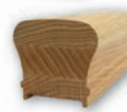

KLS6210P  
2 3/8" x 2 5/8"

KLS6400



KLS6400P  
2 1/4" x 3 1/2"

KLS6519



KLS6519P  
3" x 2 5/8"

FILLET



KLS6007  
5/16" x 1 3/4"

SHOE RAIL



KLS6006  
1" x 3 1/8"

NO FITTINGS AVAILABLE

KLS6005



KLS6005P  
2 5/16" x 2 1/2"

KLS6810

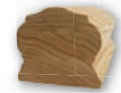

KLS6810P  
2 1/4" x 2 5/8"

STANDARD FITTINGS AVAILABLE

KLS6910



KLS6910P  
2 3/8" x 2 5/8"

KLS6710



KLS6710P  
2 3/4" x 2 5/8"

## Balusters



KLSR 2105

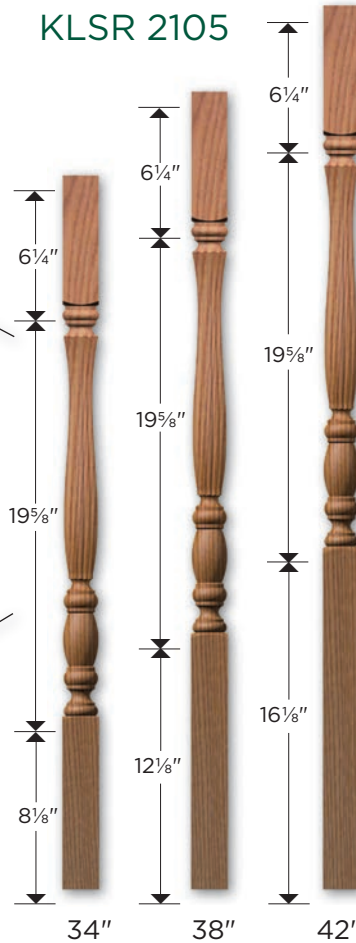

KLSR 2115

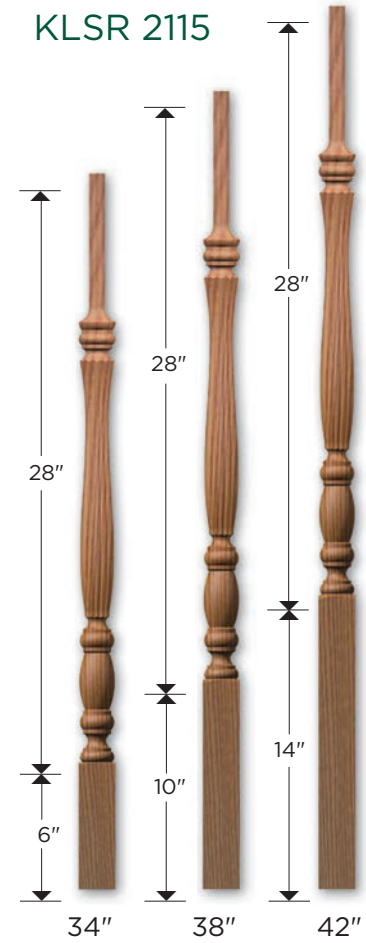

# Keim

# Newels

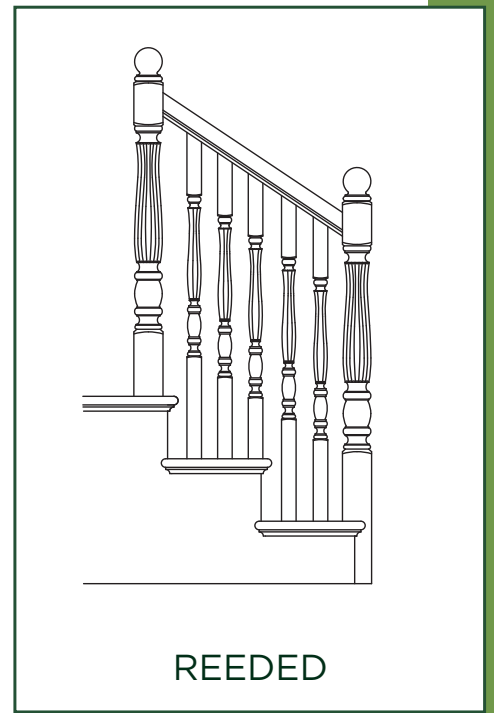
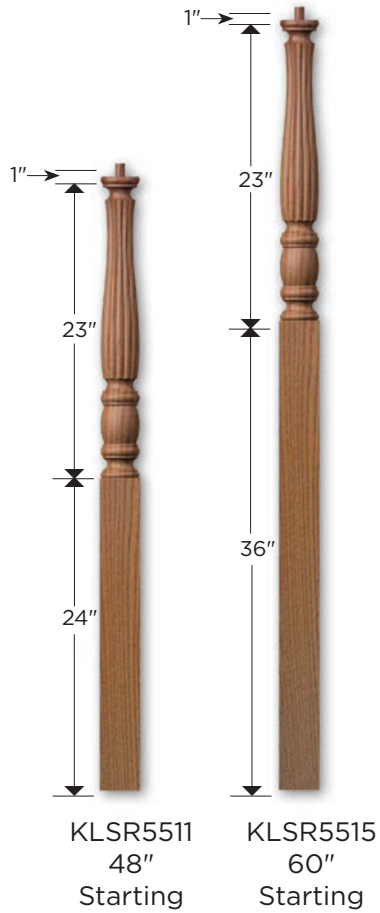

## 3 1/2" Newels

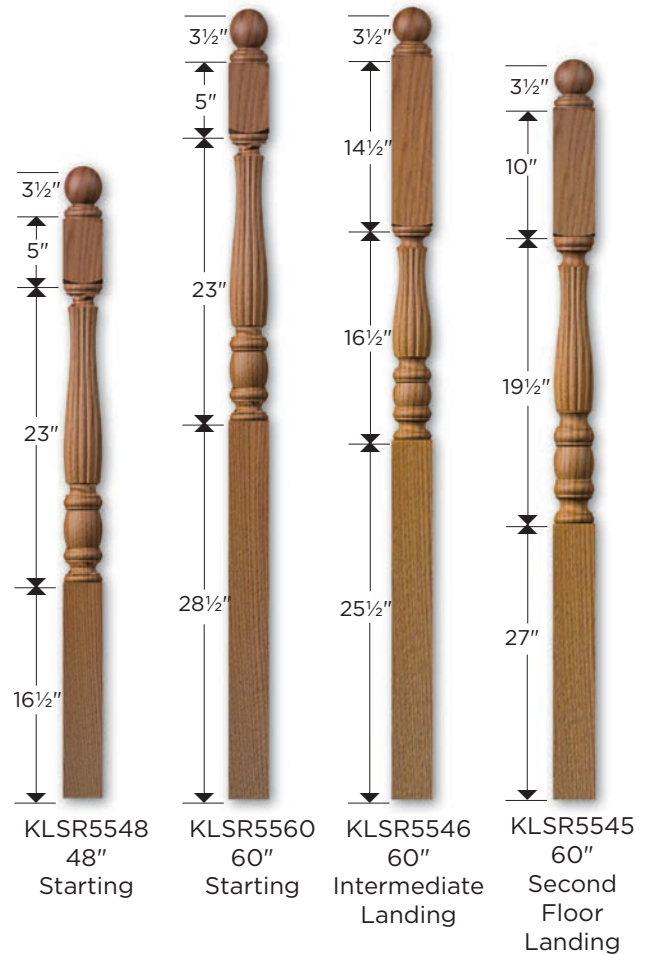

**Keim**

# Hand Rail

STANDARD OR CONECT-A-KIT™ FITTINGS AVAILABLE

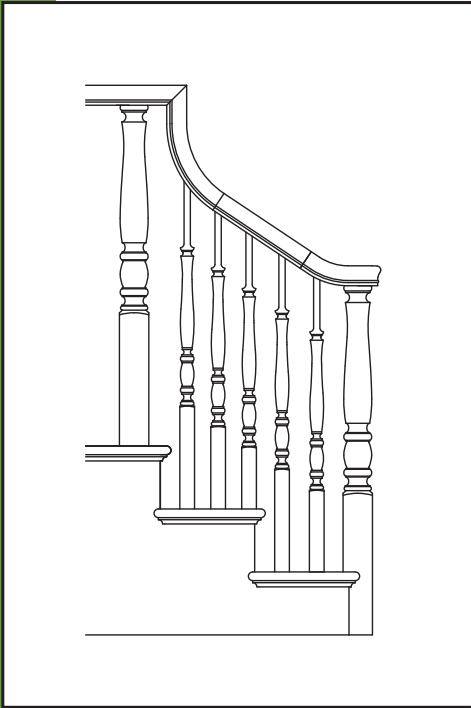

KLS6109 KLS6210 KLS6400 KLS6519

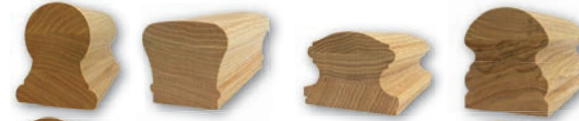

FILLET



SHOE RAIL



KLS6109P1 KLS6210P KLS6400P KLS6519P  
27/8" x 23/8" 23/8" x 25/8" 21/4" x 31/32" 3" x 25/8"

KLS6006  
1" x 31/8"

NO FITTINGS AVAILABLE

KLS6005 KLS6810



KLS6005P KLS6810P  
25/16" x 21/2" 21/4" x 25/8"

STANDARD FITTINGS AVAILABLE

KLS6910 KLS6710



KLS6910P KLS6710P  
23/8" x 25/8" 23/4" x 25/8"

## 13/4" Balusters

## Balusters

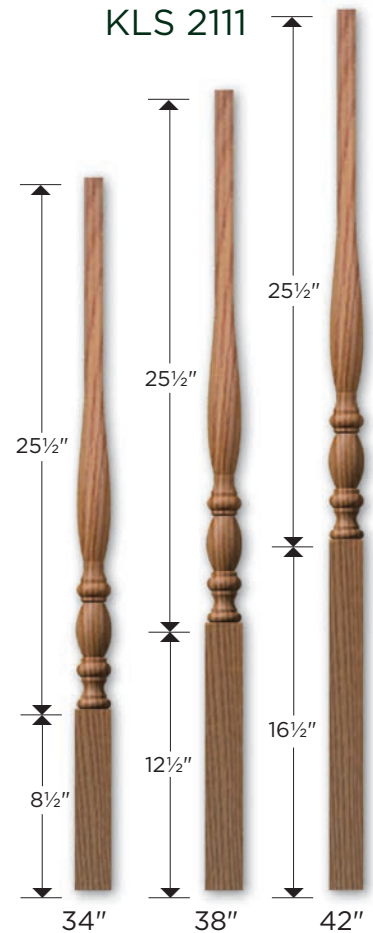
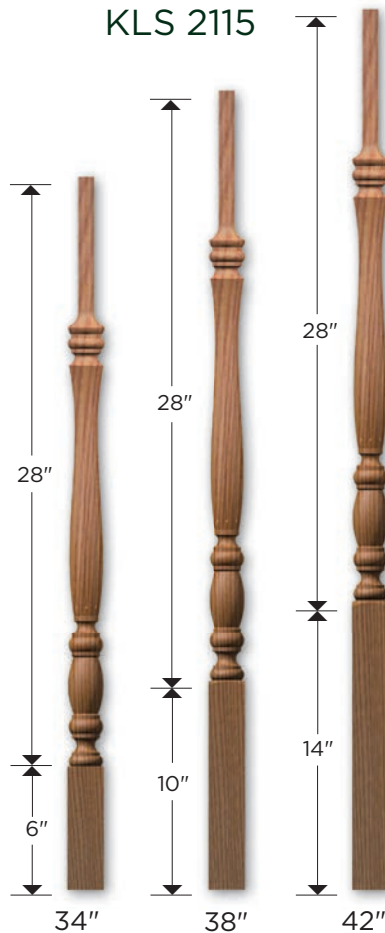
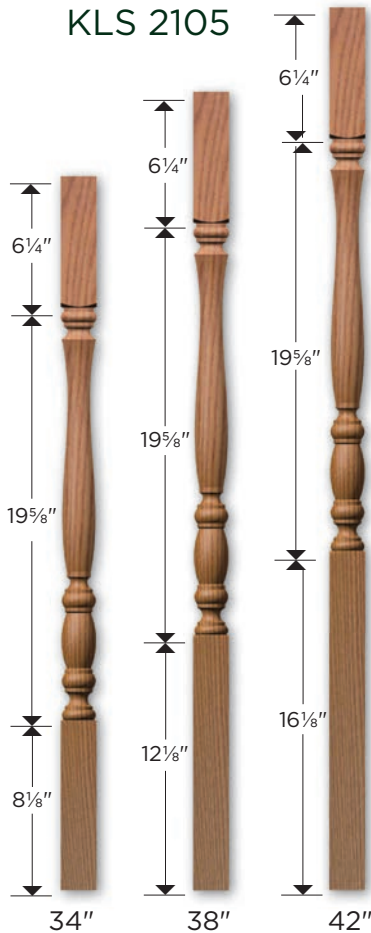

# Keim

# Newels

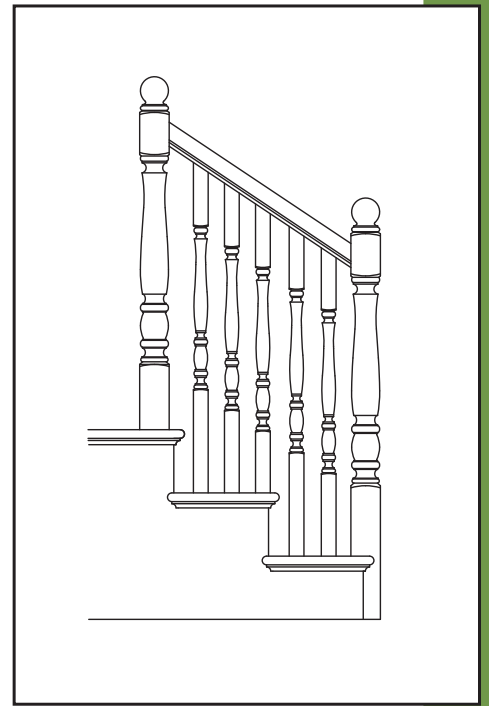
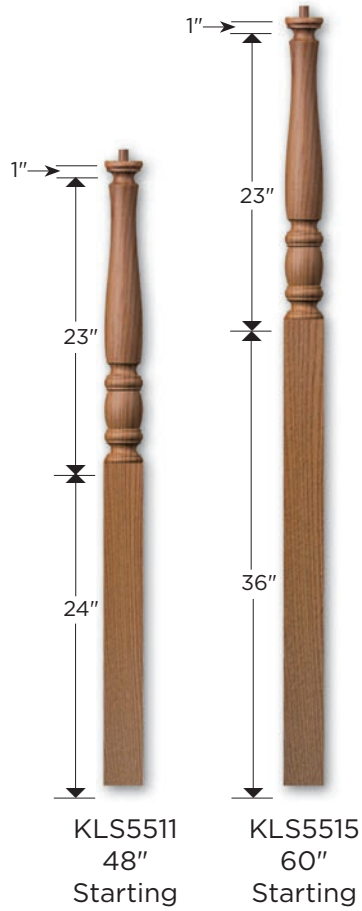

## 3 1/2" Newels

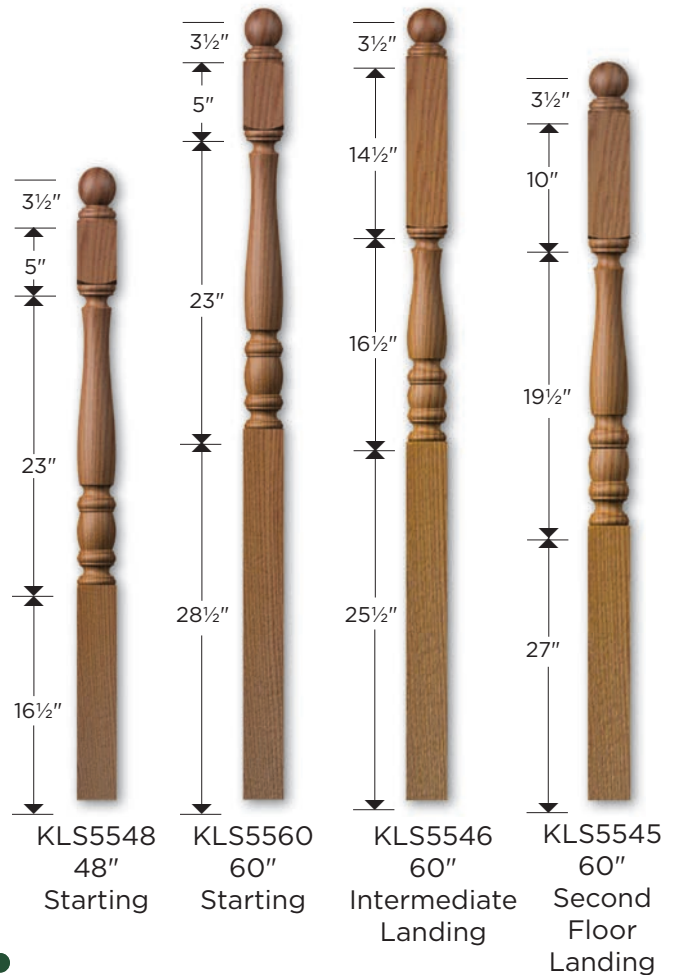
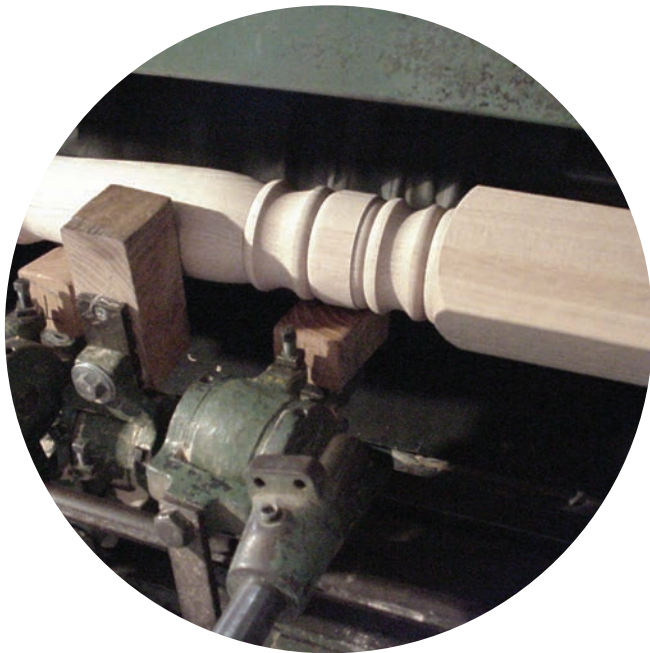

**Keim**

# Hand Rail

STANDARD OR CONECT-A-KIT™ FITTINGS AVAILABLE

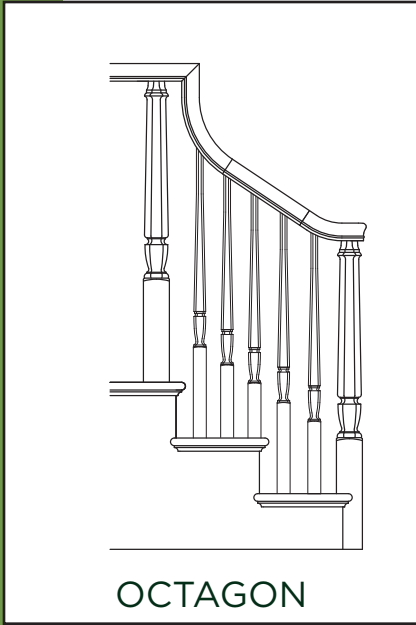

1<sup>3</sup>/<sub>4</sub>" Balusters

KLS6109	KLS6210	KLS6400	KLS6519	<b>FILLET</b> KLS6007 5 <sup>5</sup> / <sub>16</sub> " x 1 <sup>3</sup> / <sub>4</sub> "
KLS6109P1 2 <sup>7</sup> / <sub>8</sub> " x 2 <sup>3</sup> / <sub>8</sub> "	KLS6210P 2 <sup>3</sup> / <sub>8</sub> " x 2 <sup>5</sup> / <sub>8</sub> "	KLS6400P 2 <sup>1</sup> / <sub>4</sub> " x 3 <sup>1</sup> / <sub>32</sub> "	KLS6519P 3" x 2 <sup>5</sup> / <sub>8</sub> "	<b>SHOE RAIL</b> KLS6006 1" x 3 <sup>1</sup> / <sub>8</sub> "
<b>NO FITTINGS AVAILABLE</b>		<b>STANDARD FITTINGS AVAILABLE</b>		
KLS6005	KLS6810	KLS6910	KLS6710	
KLS6005P 2 <sup>5</sup> / <sub>16</sub> " x 2 <sup>1</sup> / <sub>2</sub> "	KLS6810P 2 <sup>1</sup> / <sub>4</sub> " x 2 <sup>5</sup> / <sub>8</sub> "	KLS6910P 2 <sup>3</sup> / <sub>8</sub> " x 2 <sup>5</sup> / <sub>8</sub> "	KLS6710P 2 <sup>3</sup> / <sub>4</sub> " x 2 <sup>5</sup> / <sub>8</sub> "	

## Balusters

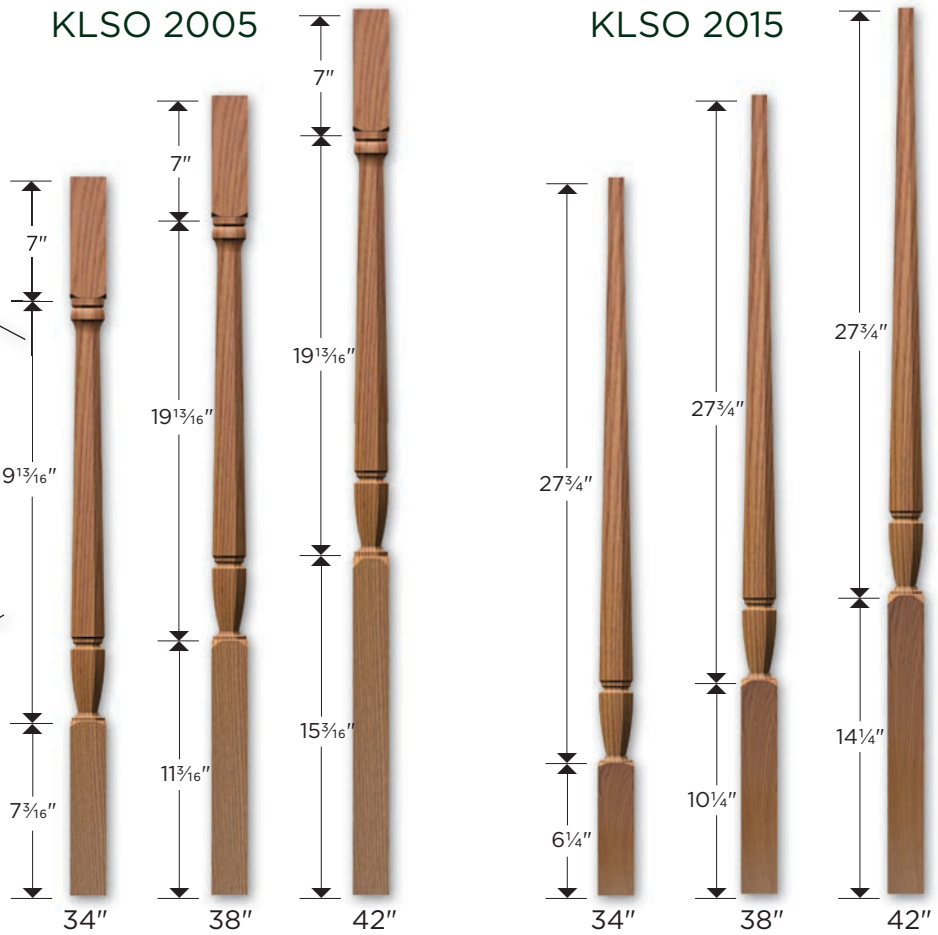



# Newels

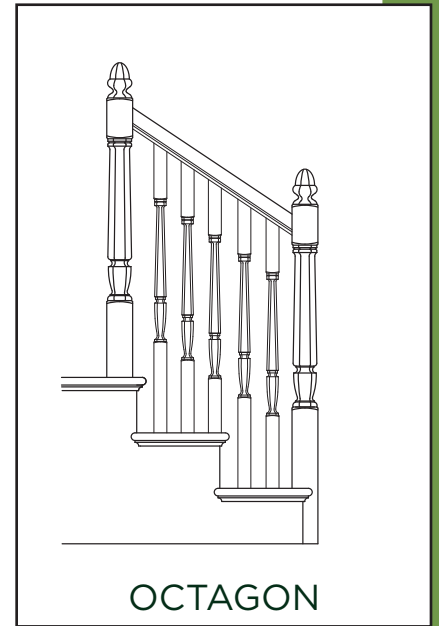
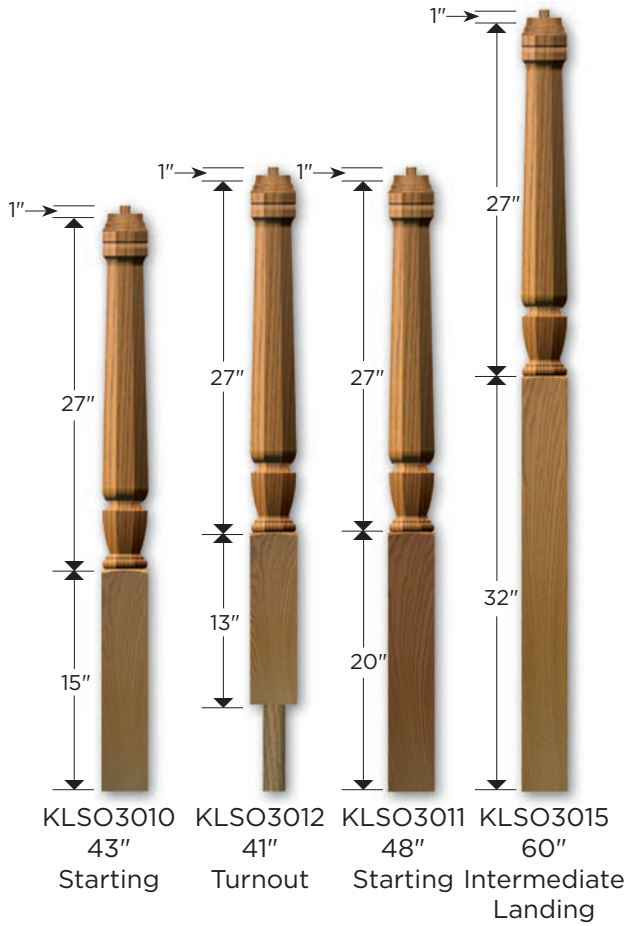

OCTAGON

**3 1/2" Newels**

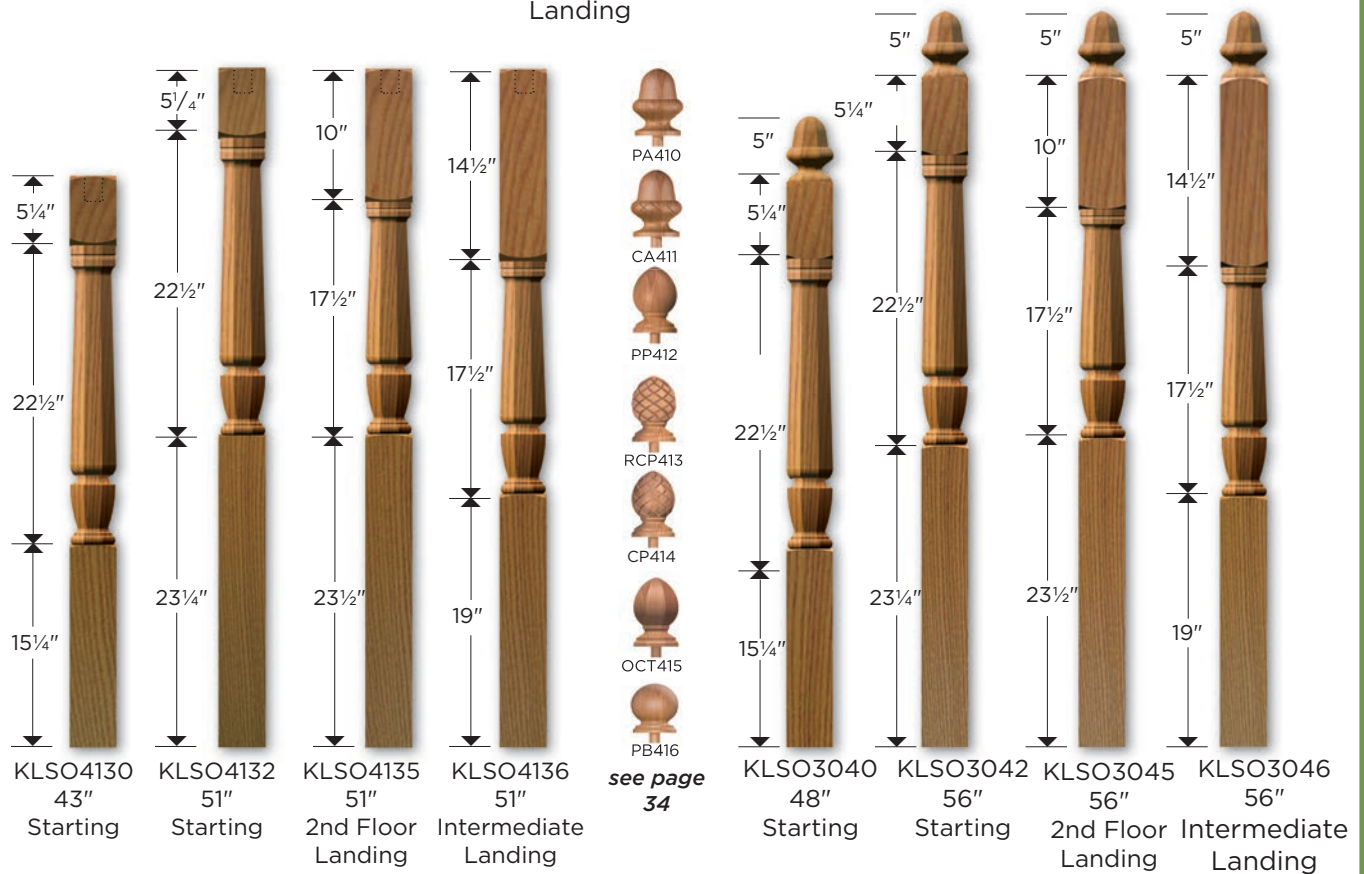

# Keim

# Hand Rail

STANDARD OR CONECT-A-KIT™ FITTINGS AVAILABLE

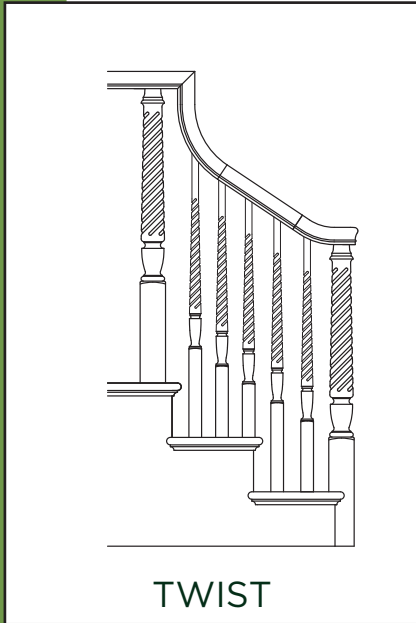

**1 3/4" Balusters**

KLS6109



KLS6210



KLS6400



KLS6519



**FILLET**



KLS6007  
5/16" x 1 3/4"



KLS6109P1  
2 7/8" x 2 3/8"



KLS6210P  
2 3/8" x 2 5/8"



KLS6400P  
2 1/4" x 3 1/32"



KLS6519P  
3" x 2 5/8"

**SHOE RAIL**



KLS6006  
1" x 3 1/8"

**NO FITTINGS AVAILABLE**

KLS6005



KLS6005P  
2 5/16" x 2 1/2"

KLS6810



KLS6810P  
2 1/4" x 2 5/8"

**STANDARD FITTINGS AVAILABLE**

KLS6910



KLS6910P  
2 3/8" x 2 5/8"

KLS6710



KLS6710P  
2 3/4" x 2 5/8"

## Balusters

KLST 2005

KLST 2015

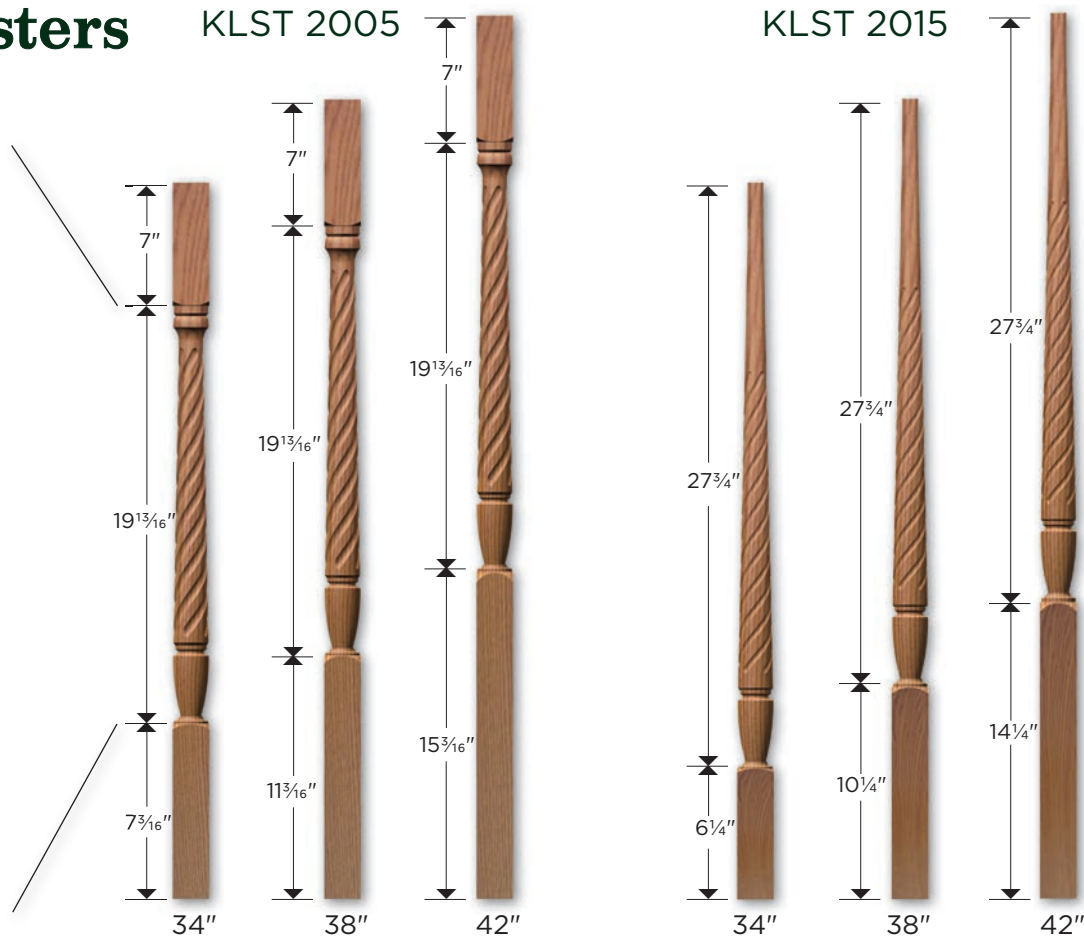
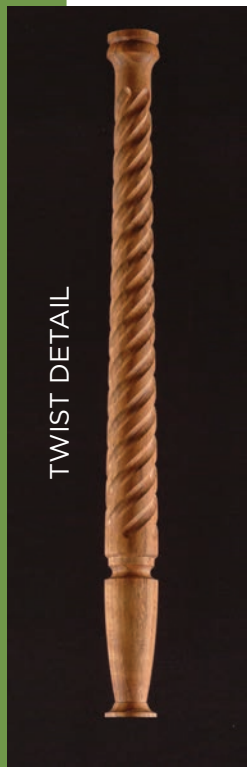

# Keim

# Newels

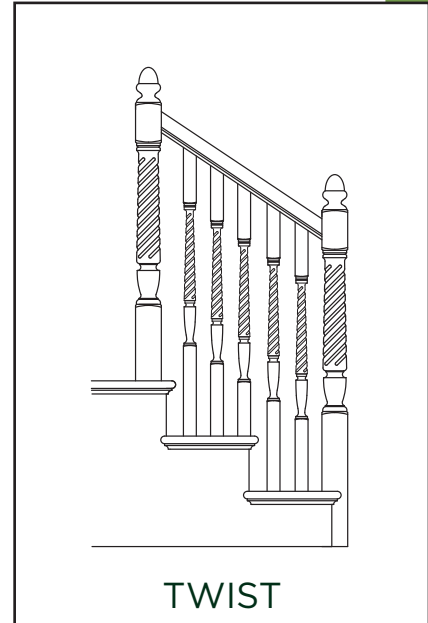
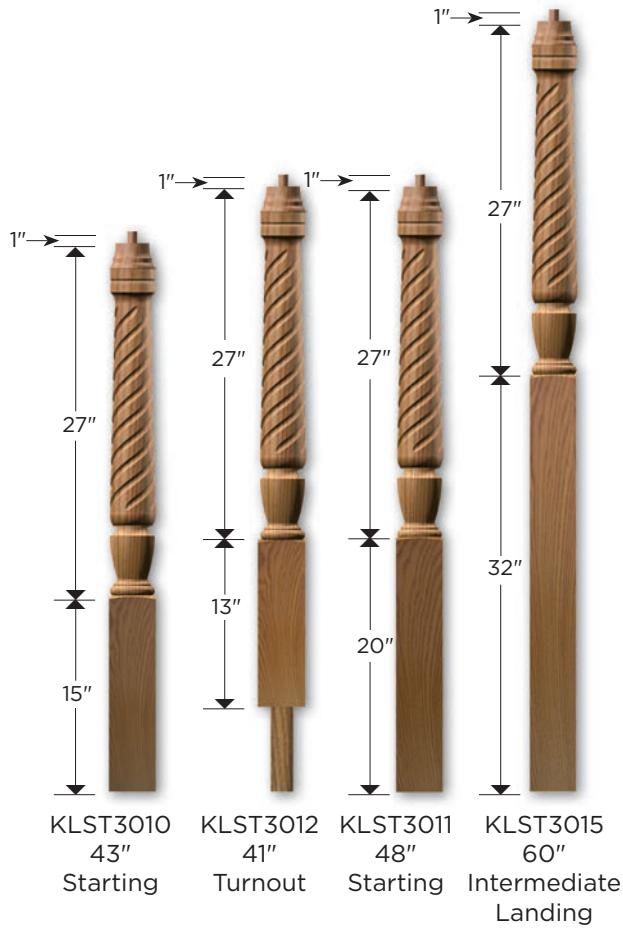

## 3 1/2" Newels

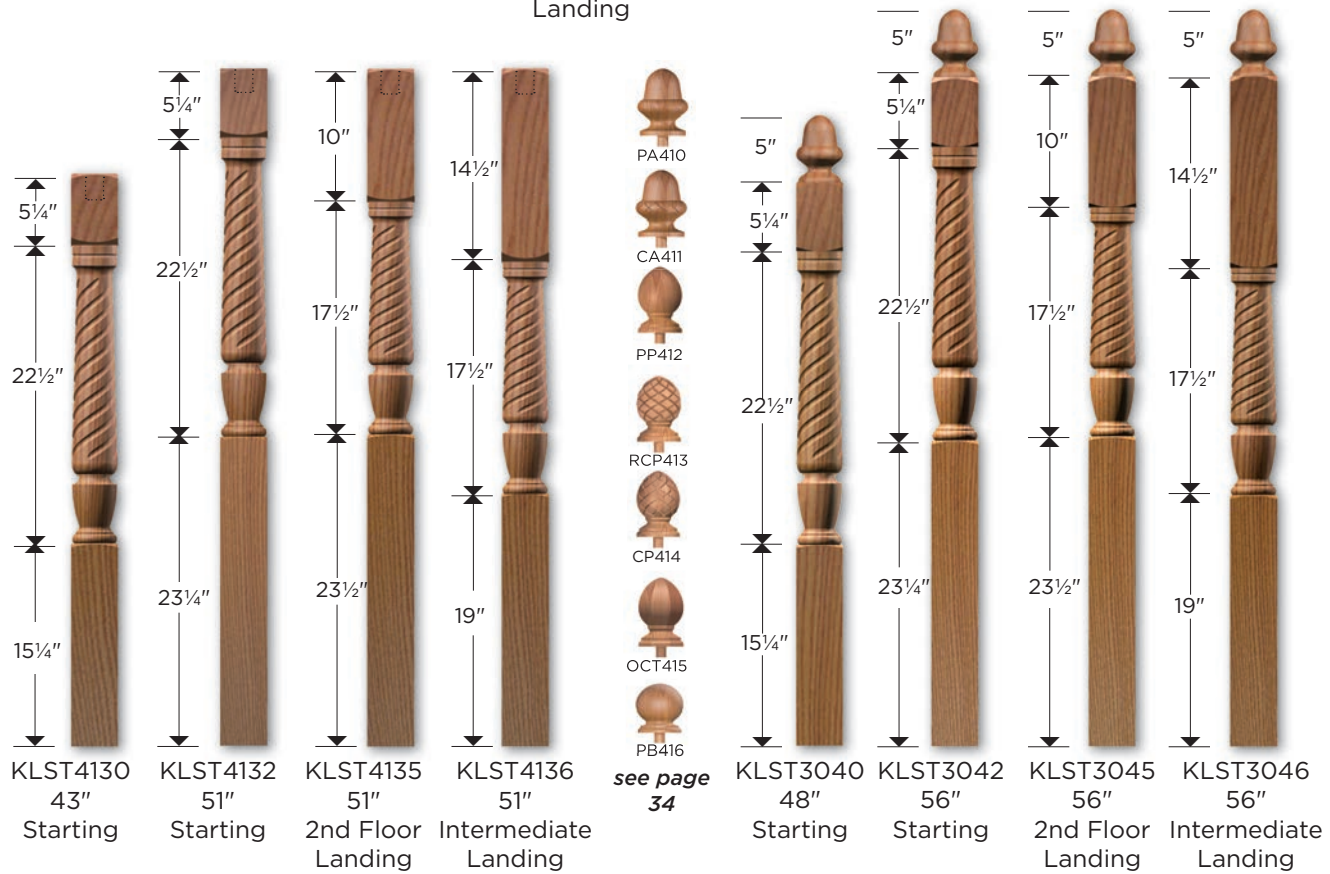

# Hand Rail

STANDARD OR CONECT-A-KIT™ FITTINGS AVAILABLE

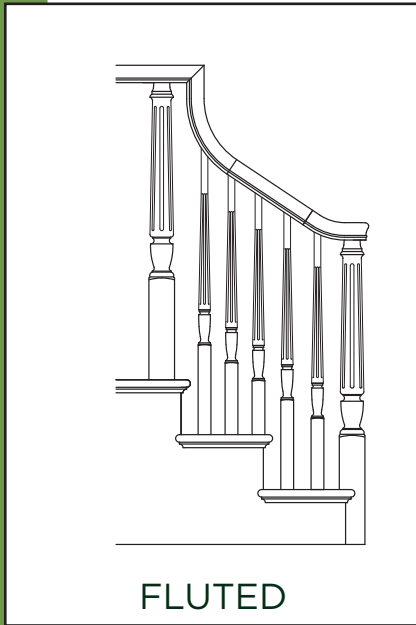

1 3/4" Balusters

KLS6109 KLS6210 KLS6400 KLS6519



KLS6109P1 2 7/8" x 2 3/8"  
 KLS6210P 2 3/8" x 2 5/8"  
 KLS6400P 2 1/4" x 3 1/2"  
 KLS6519P 3" x 2 5/8"

FILLET



SHOE RAIL



NO FITTINGS AVAILABLE

KLS6005 KLS6810



KLS6005P 2 5/16" x 2 1/2"  
 KLS6810P 2 1/4" x 2 5/8"

STANDARD FITTINGS AVAILABLE

KLS6910 KLS6710



KLS6910P 2 3/8" x 2 5/8"  
 KLS6710P 2 3/4" x 2 5/8"

## Balusters



KLSF 2005



KLSF 2015

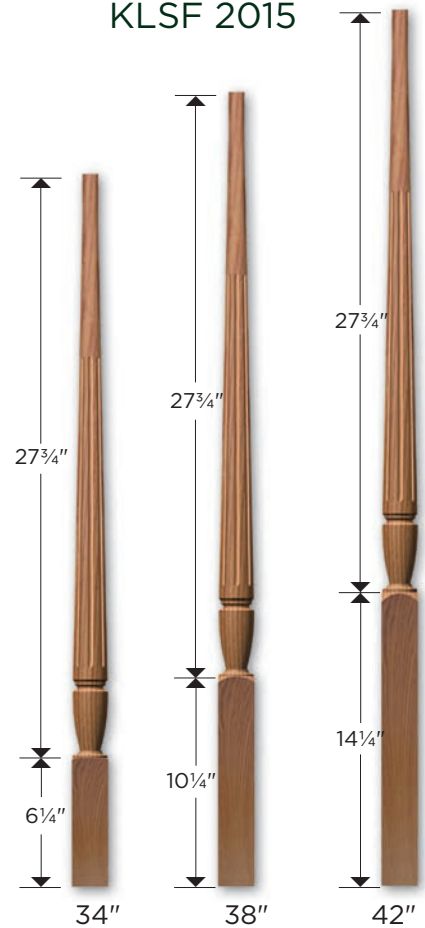

# Keim

# Newels

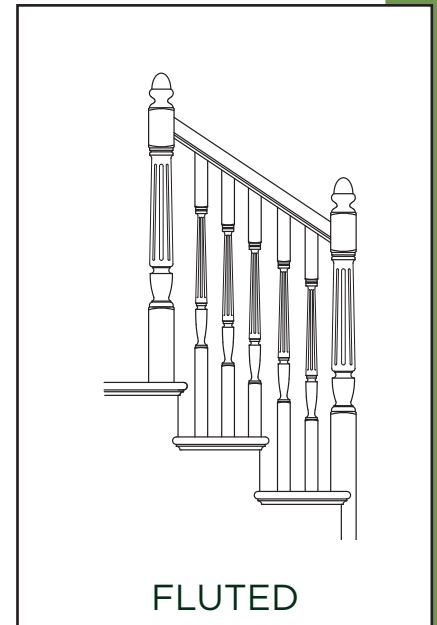
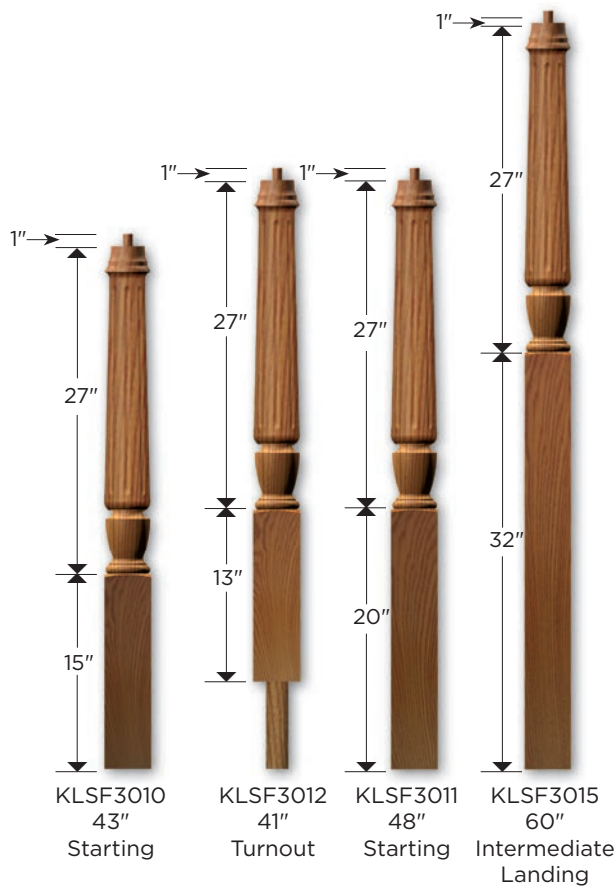

**FLUTED**  
**3½" Newels**

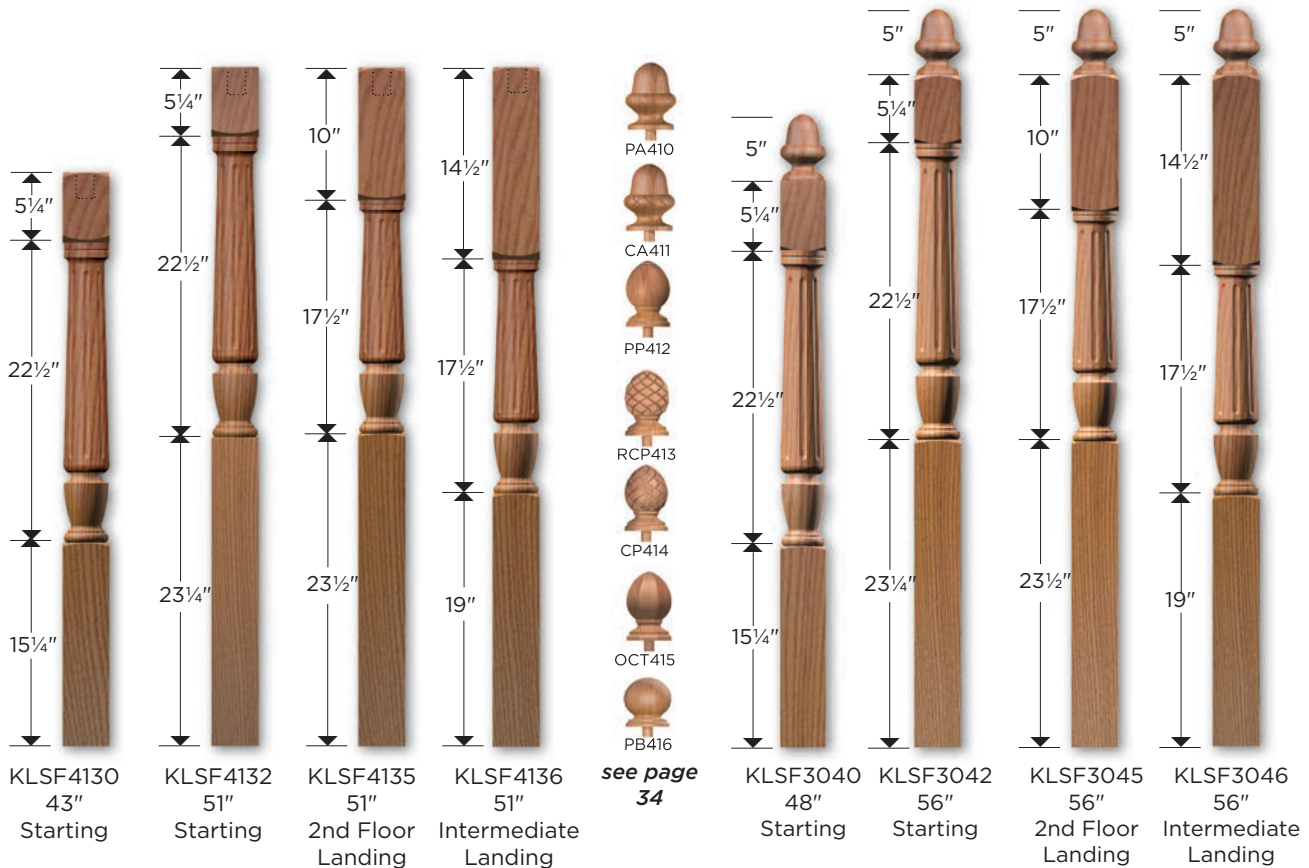

# Keim

# Hand Rail

STANDARD OR CONECT-A-KIT™ FITTINGS AVAILABLE

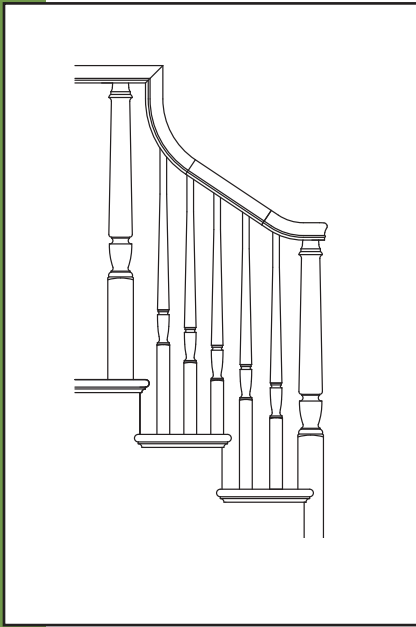

1 3/4" Balusters

KLS6109 KLS6210 KLS6400 KLS6519



**FILLET**

KLS6007  
5/16" x 1 3/4"

**SHOE RAIL**



KLS6006  
1" x 3 1/8"

KLS6109P1 KLS6210P KLS6400P KLS6519P  
2 7/8" x 2 3/8" 2 3/8" x 2 5/8" 2 1/4" x 3 1/32" 3" x 2 5/8"

**NO FITTINGS AVAILABLE**

KLS6005 KLS6810



KLS6005P KLS6810P  
2 5/16" x 2 1/2" 2 1/4" x 2 5/8"

**STANDARD FITTINGS AVAILABLE**

KLS6910 KLS6710



KLS6910P KLS6710P  
2 3/8" x 2 5/8" 2 3/4" x 2 5/8"

## Balusters

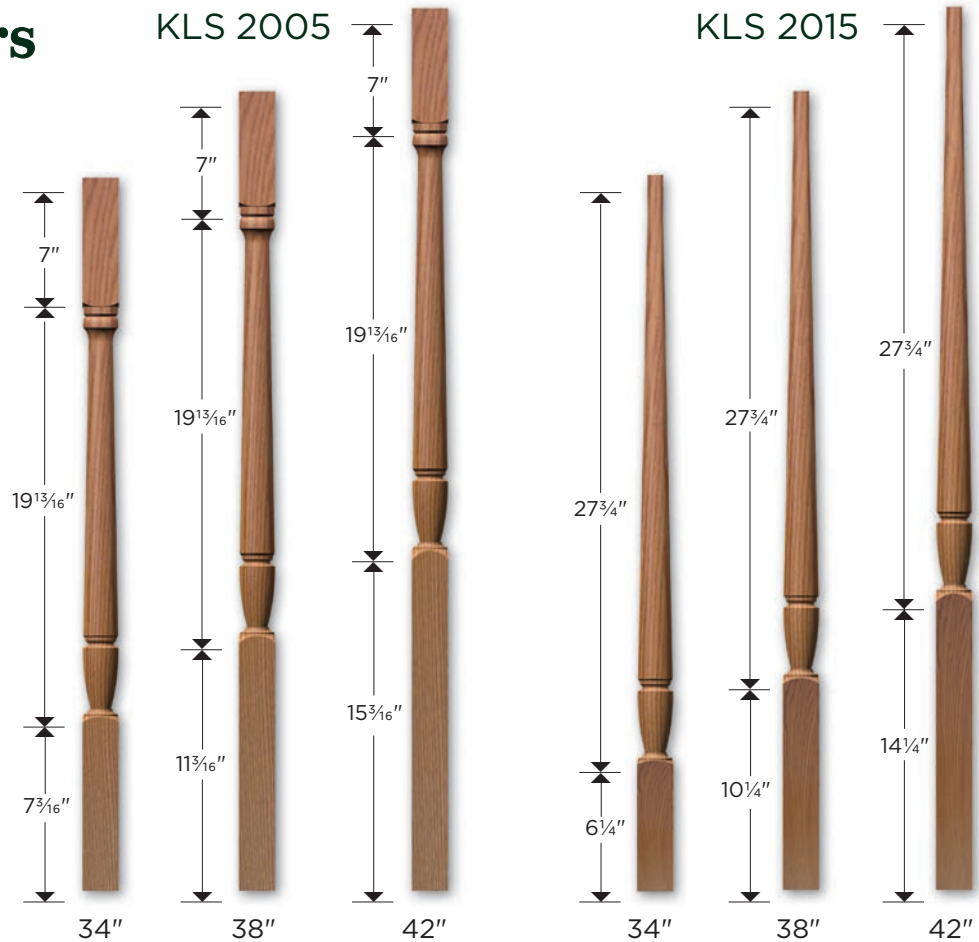

# Keim

# Newels

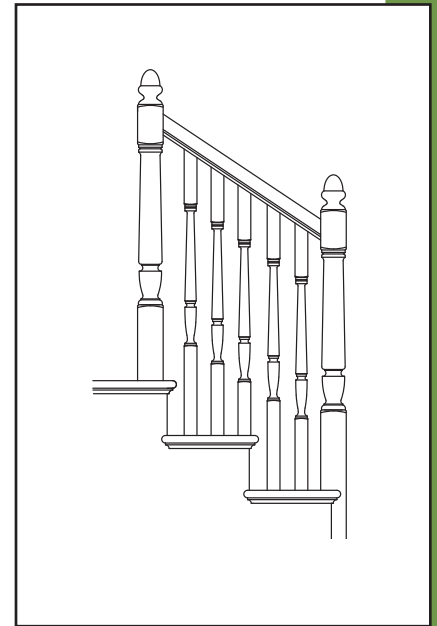
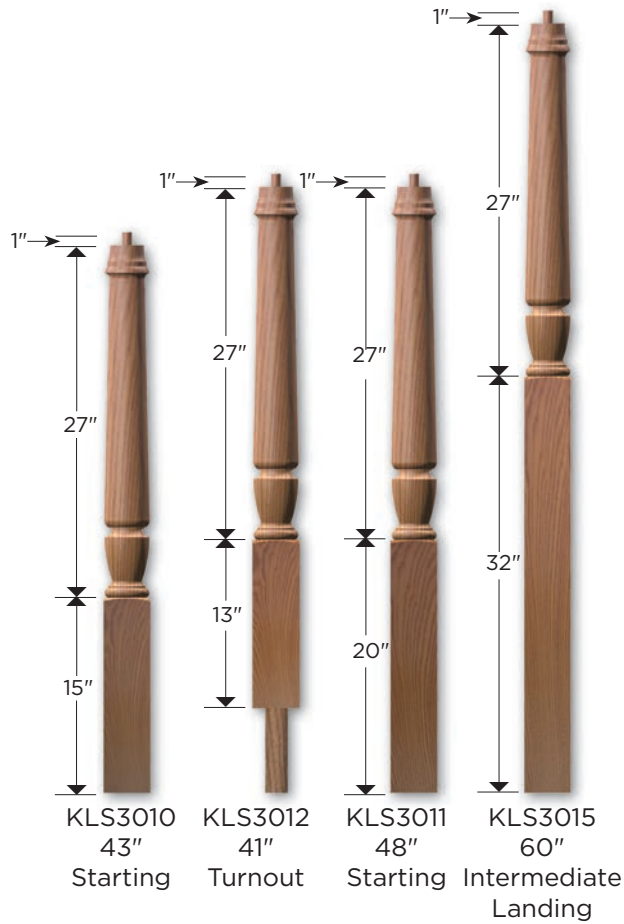

**3 1/2" Newels**

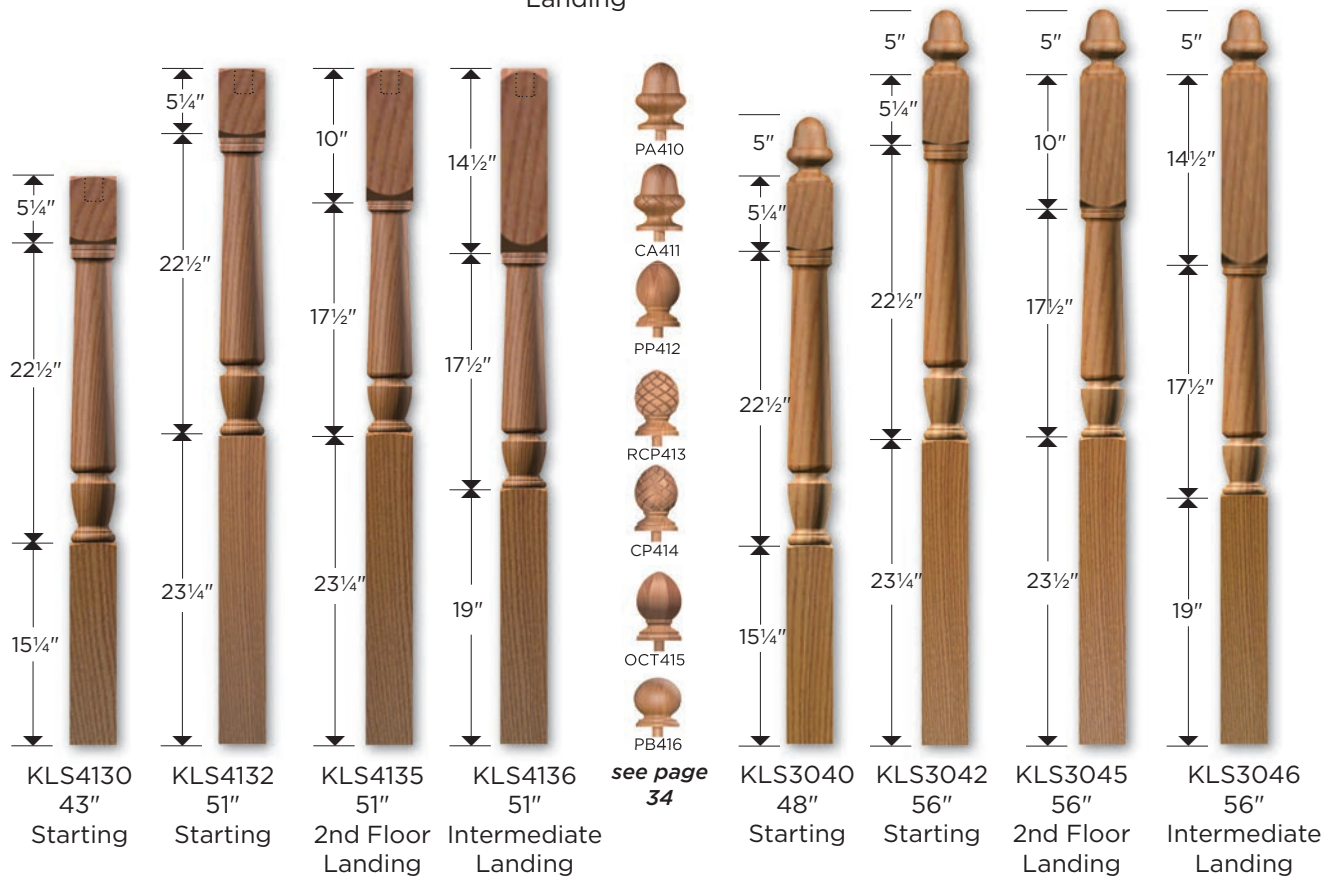

# Keim

# Hand Rail

STANDARD OR CONECT-A-KIT™ FITTINGS AVAILABLE

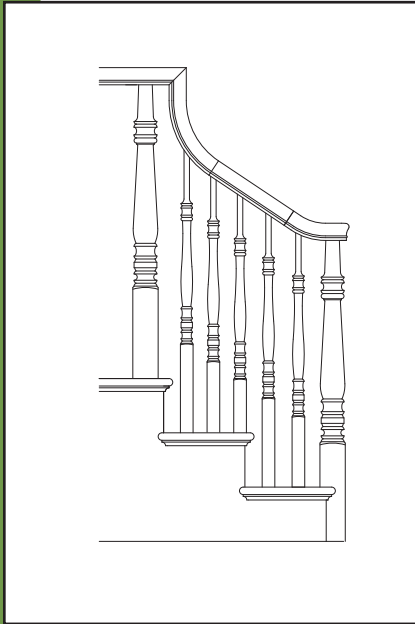

1 3/4" Balusters

KLS6109



KLS6210



KLS6400



KLS6519



**FILLET**



KLS6007  
5/16" x 1 3/4"

**SHOE RAIL**



KLS6006  
1" x 3 1/8"



KLS6109P1  
2 7/8" x 2 3/8"



KLS6210P  
2 3/8" x 2 5/8"



KLS6400P  
2 1/4" x 3 1/2"



KLS6519P  
3" x 2 5/8"

**NO FITTINGS AVAILABLE**

KLS6005



KLS6005P  
2 5/16" x 2 1/2"

KLS6810



KLS6810P  
2 1/4" x 2 5/8"



**STANDARD FITTINGS AVAILABLE**

KLS6910



KLS6910P  
2 3/8" x 2 5/8"

KLS6710



KLS6710P  
2 3/4" x 2 5/8"



## Balusters

KLS 5005

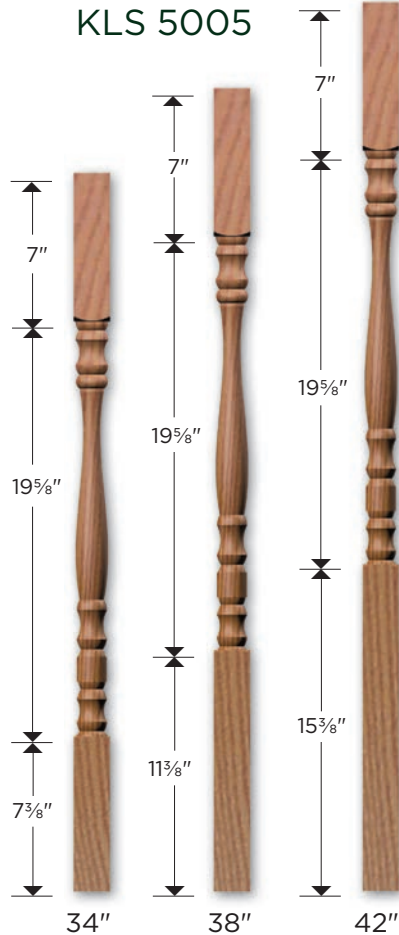

KLS 5300



# Keim



# Newels

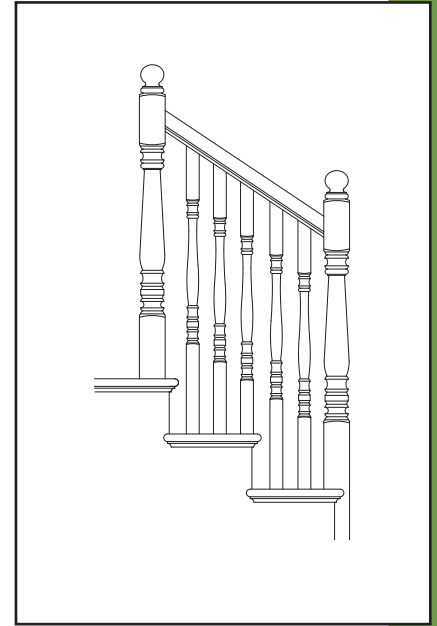
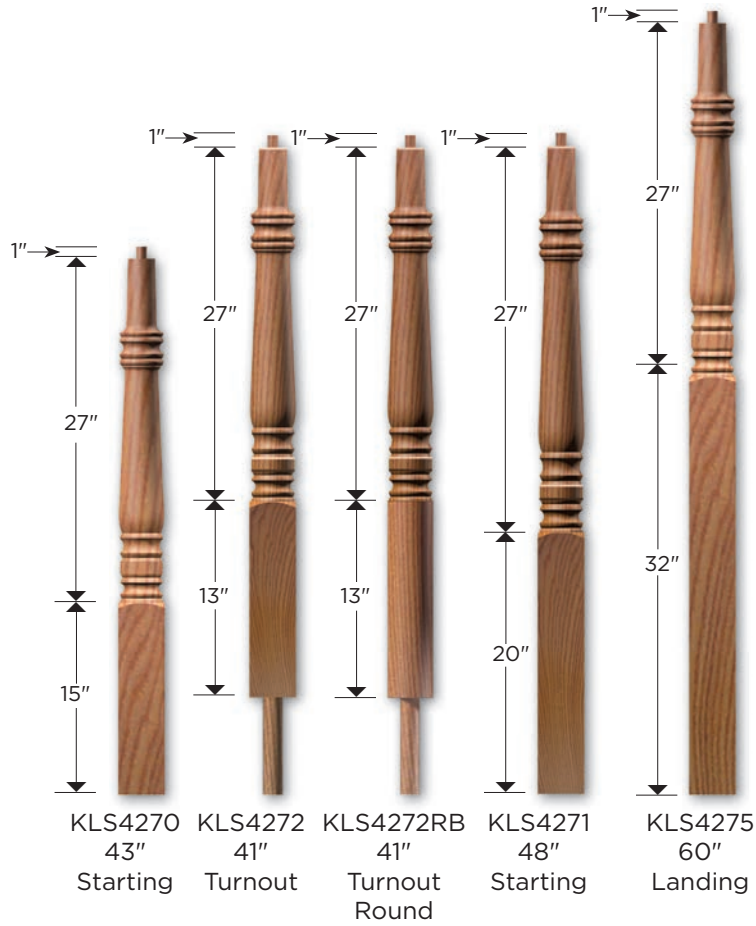

## 3 1/2" Newels



**Keim**

# Hand Rail

STANDARD OR CONECT-A-KIT™ FITTINGS AVAILABLE

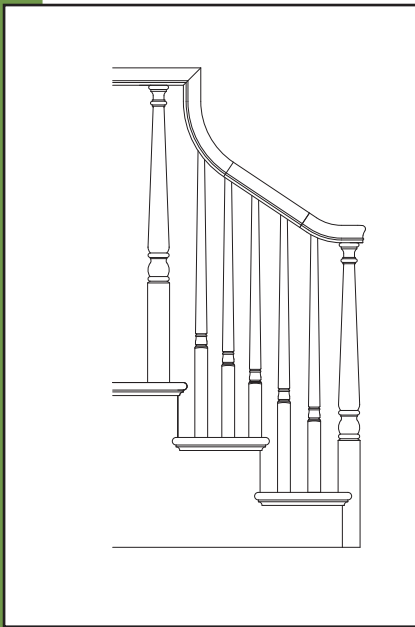

1 3/4" Balusters

KLS6109



KLS6210



KLS6400



KLS6519



**FILLET**



KLS6007  
5/16" x 1 3/4"

**SHOE RAIL**



KLS6006  
1" x 3 1/8"

KLS6109P1  
2 7/8" x 2 3/8"

KLS6210P  
2 3/8" x 2 5/8"

KLS6400P  
2 1/4" x 3 1/2"

KLS6519P  
3" x 2 5/8"

**NO FITTINGS AVAILABLE**

KLS6005



KLS6810



**STANDARD FITTINGS AVAILABLE**

KLS6910



KLS6710



KLS6005P  
2 5/16" x 2 1/2"

KLS6810P  
2 1/4" x 2 5/8"

KLS6910P  
2 3/8" x 2 5/8"

KLS6710P  
2 3/4" x 2 5/8"

## Balusters



# Keim

# Newels

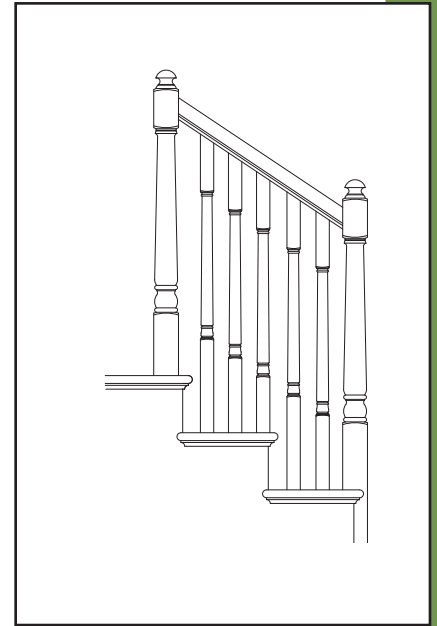

**3¼" Newels**

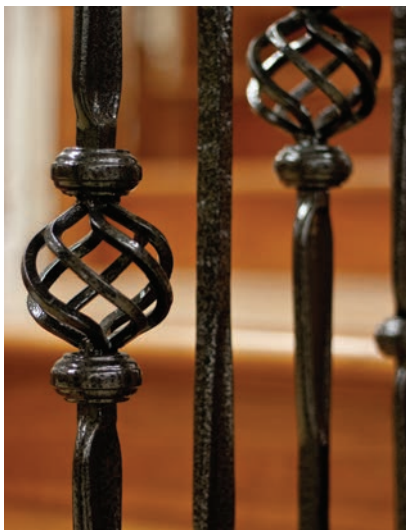

Iron and steel balusters available.

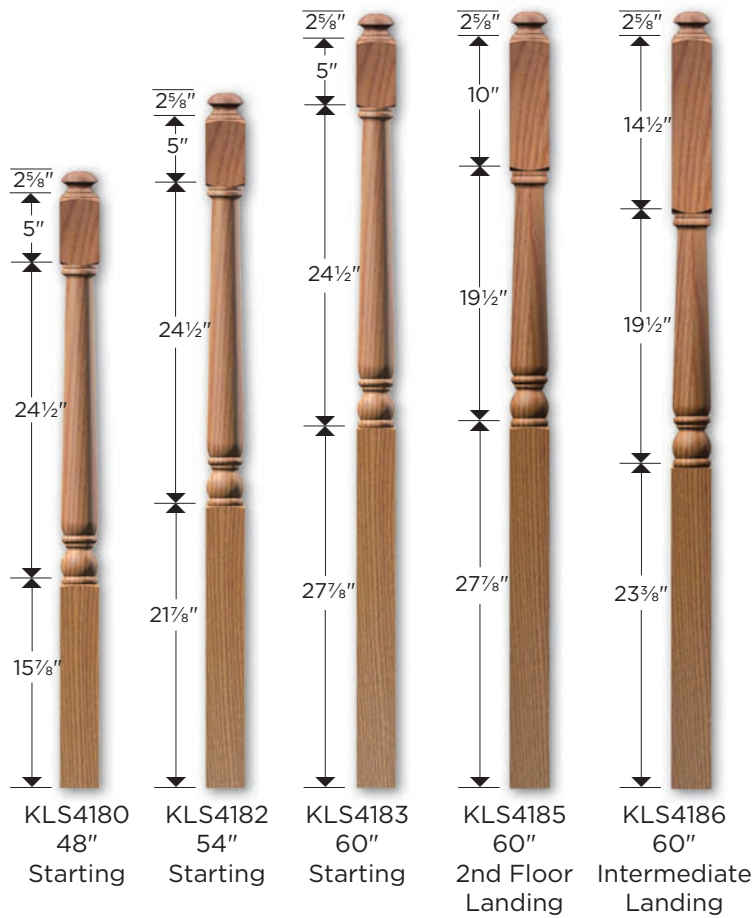

**Keim**

# Hand Rail

STANDARD OR CONECT-A-KIT™ FITTINGS AVAILABLE

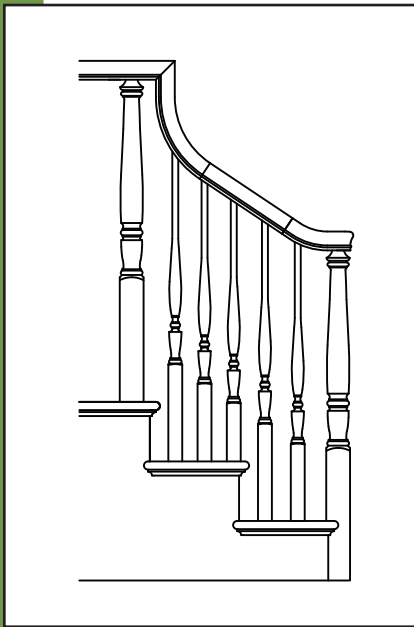

1 3/4" Balusters

KLS6109 KLS6210 KLS6400 KLS6519

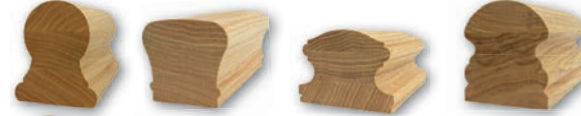

KLS6109P1 2 7/8" x 2 3/8"  
 KLS6210P 2 3/8" x 2 5/8"  
 KLS6400P 2 1/4" x 3 1/2"  
 KLS6519P 3" x 2 5/8"

**FILLET**



KLS6007  
 5/16" x 1 3/4"

**SHOE RAIL**



KLS6006  
 1" x 3 1/8"

**NO FITTINGS AVAILABLE**

KLS6005 KLS6810



KLS6005P 2 5/16" x 2 1/2"  
 KLS6810P 2 1/4" x 2 5/8"

**STANDARD FITTINGS AVAILABLE**

KLS6910 KLS6710



KLS6910P 2 3/8" x 2 5/8"  
 KLS6710P 2 3/4" x 2 5/8"

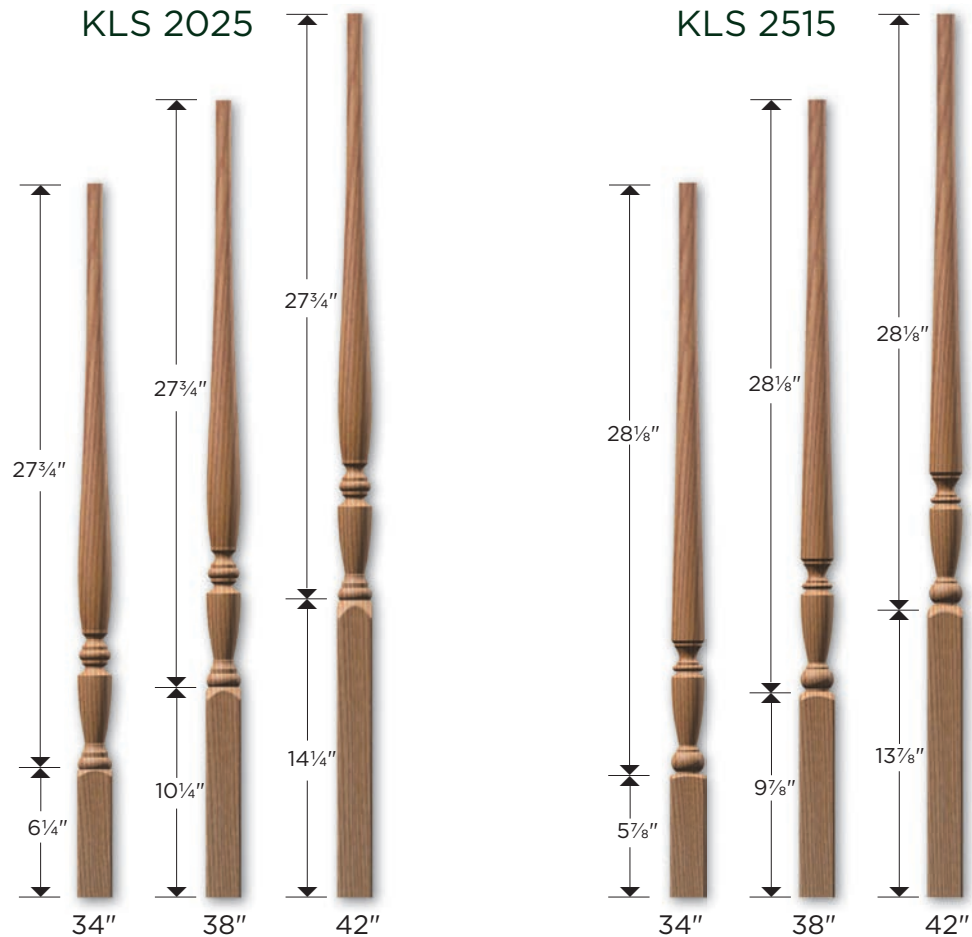

# Keim

# Newels

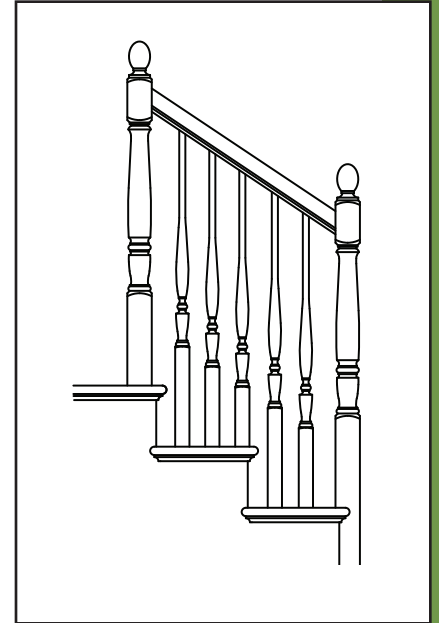
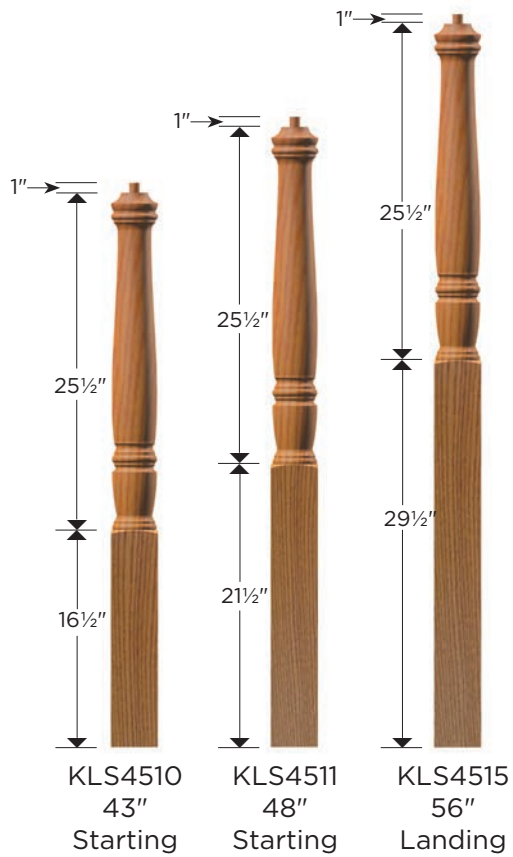

**3 1/2" Newels**



**Keim**

# Hand Rail

STANDARD OR CONECT-A-KIT™ FITTINGS AVAILABLE

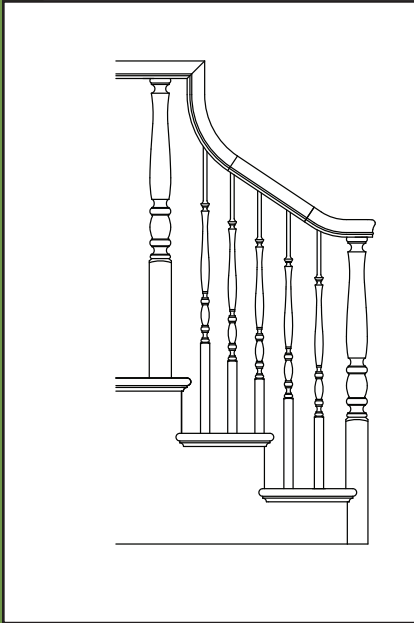

## CONECT-A-KIT™ FITTINGS AVAILABLE

## NO FITTINGS AVAILABLE

KLS6109



KLS6109PO  
2<sup>7</sup>/<sub>8</sub>" x 2<sup>3</sup>/<sub>8</sub>"

KLS6010



KLS6010P  
2<sup>3</sup>/<sub>8</sub>" x 2<sup>1</sup>/<sub>4</sub>"

KLS6601



KLS6601P  
2<sup>1</sup>/<sub>4</sub>" x 2<sup>1</sup>/<sub>4</sub>"



KLS6112  
2<sup>3</sup>/<sub>8</sub>" x 2<sup>1</sup>/<sub>4</sub>"

### FILLET



KLS6050  
3<sup>8</sup>/<sub>8</sub>" x 1<sup>1</sup>/<sub>4</sub>"

### SHOE RAIL



KLS6045  
3<sup>4</sup>/<sub>4</sub>" x 2<sup>1</sup>/<sub>2</sub>"

## 1<sup>1</sup>/<sub>4</sub>" Balusters

## Balusters

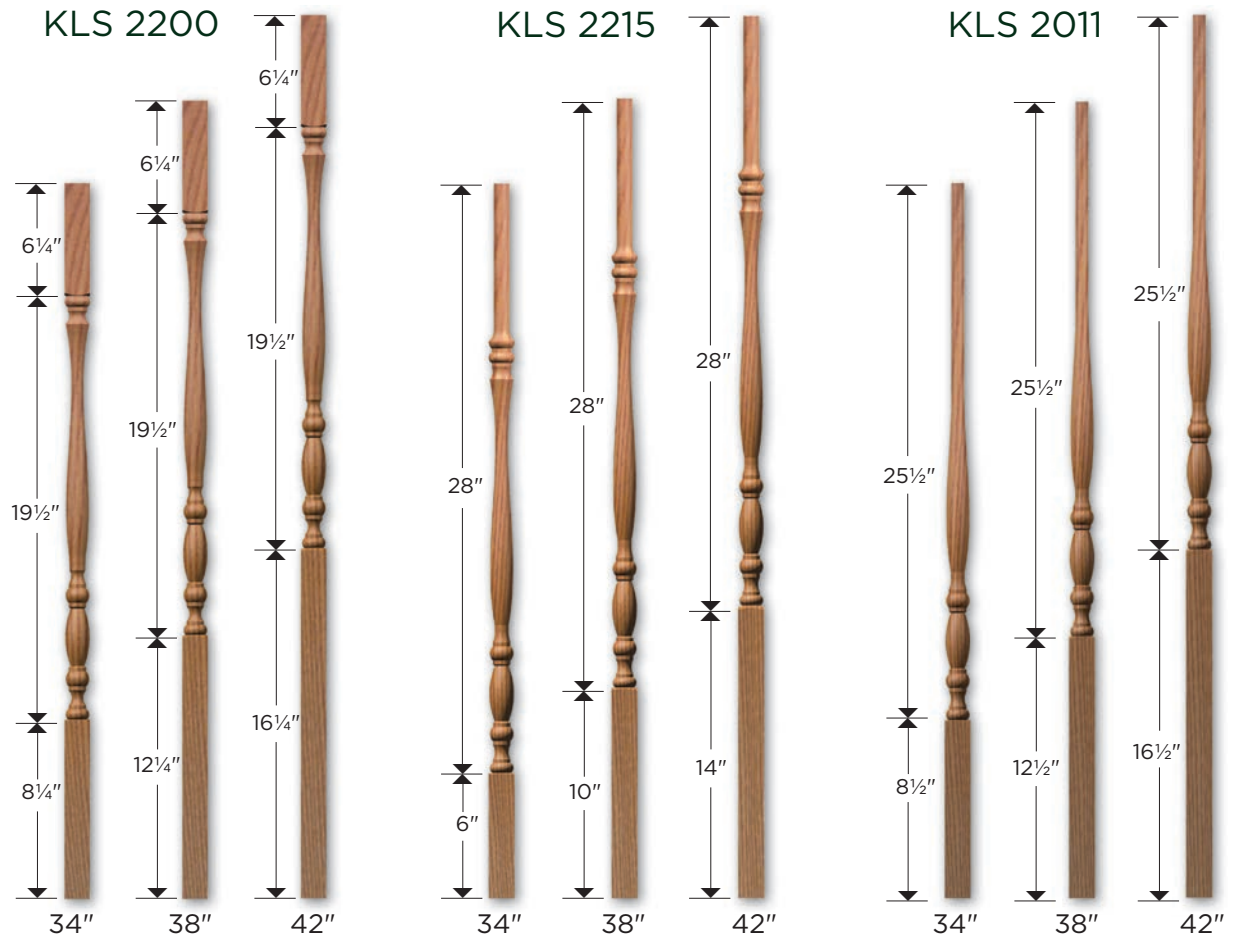

# Keim

# Newels

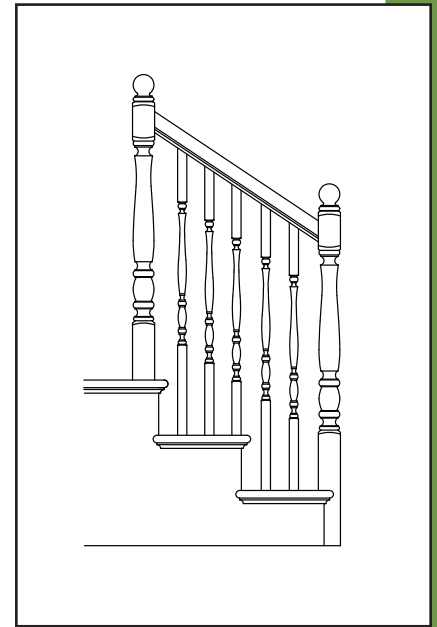
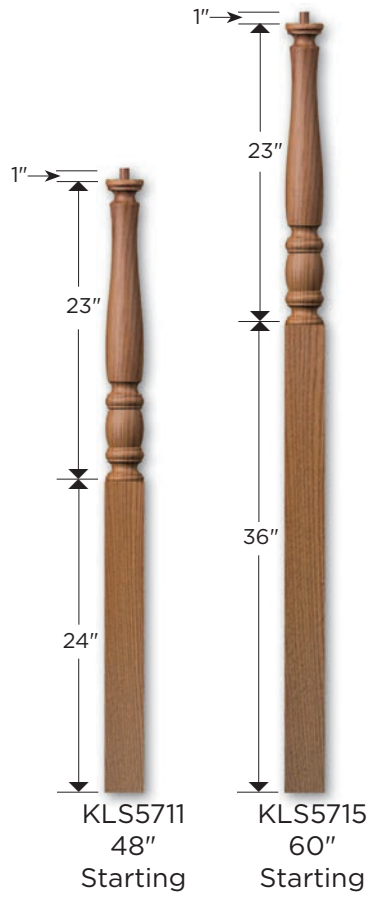

**3" Newels**

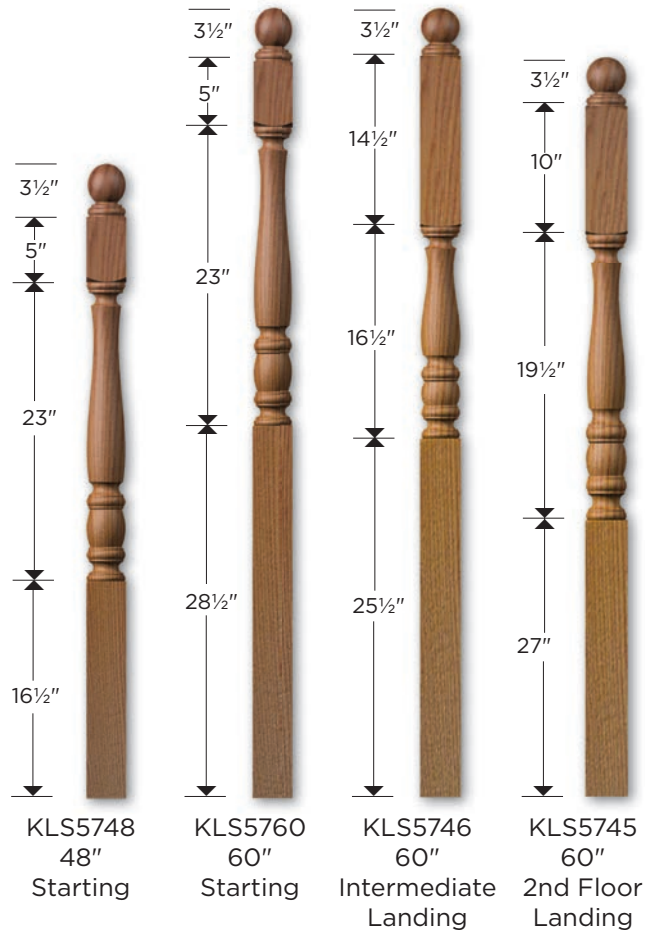

**Keim**

# Hand Rail

STANDARD OR CONECT-A-KIT™ FITTINGS AVAILABLE

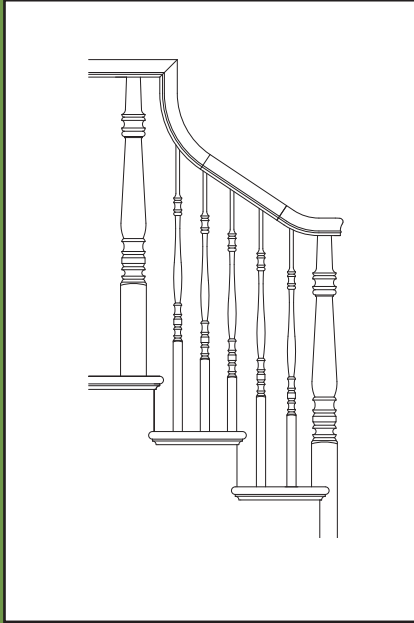

## CONECT-A-KIT™ FITTINGS AVAILABLE

KLS6109



KLS6109PO  
2 7/8" x 2 3/8"

KLS6010



KLS6010P  
2 3/8" x 2 1/4"

KLS6601



KLS6601P  
2 1/4" x 2 1/4"

## NO FITTINGS AVAILABLE



KLS6112  
2 3/8" x 2 1/4"

### FILLET



KLS6050  
3/8" x 1 1/4"

### SHOE RAIL



KLS6045  
3/4" x 2 1/2"

1 1/4" Balusters

## Balusters

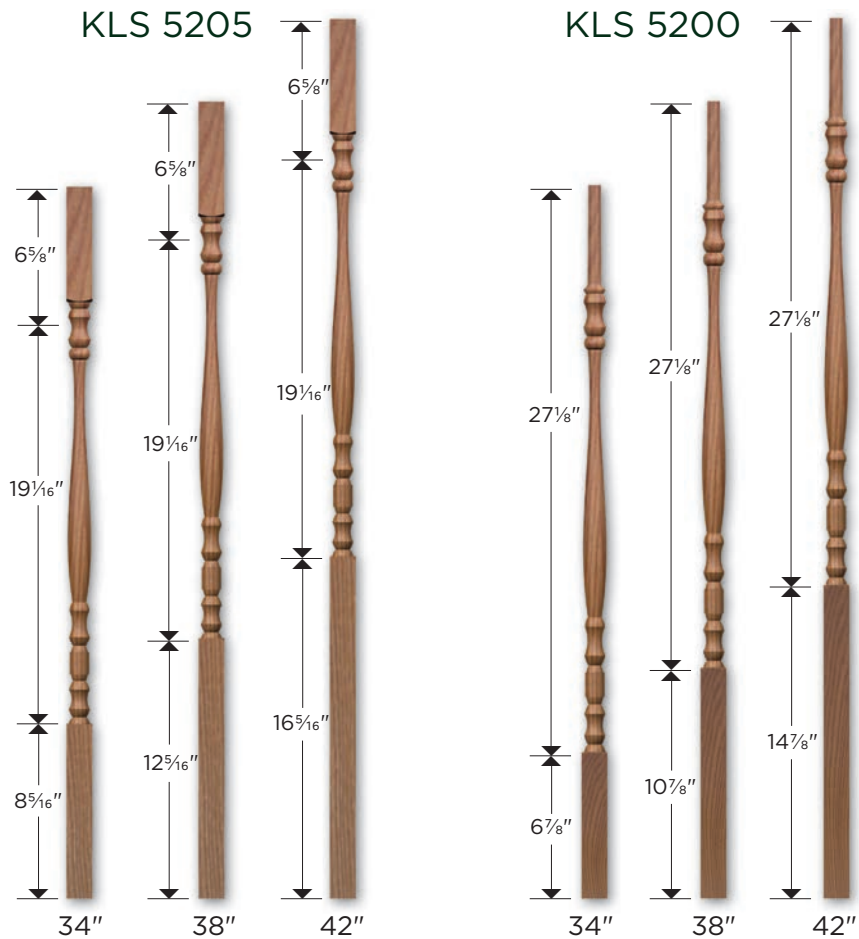

# Keim



# Newels

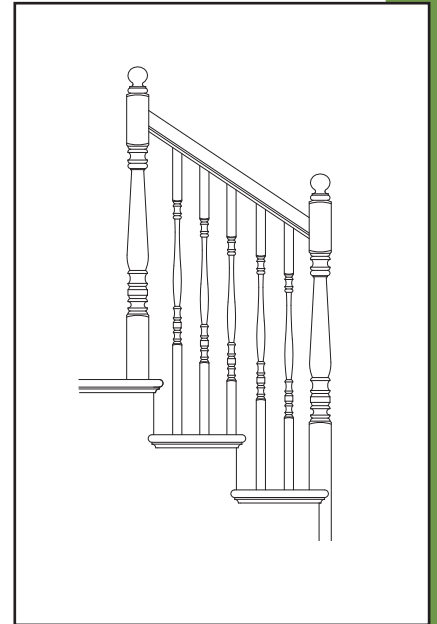

**3" Newels**



# Hand Rail

STANDARD OR CONECT-A-KIT™ FITTINGS AVAILABLE

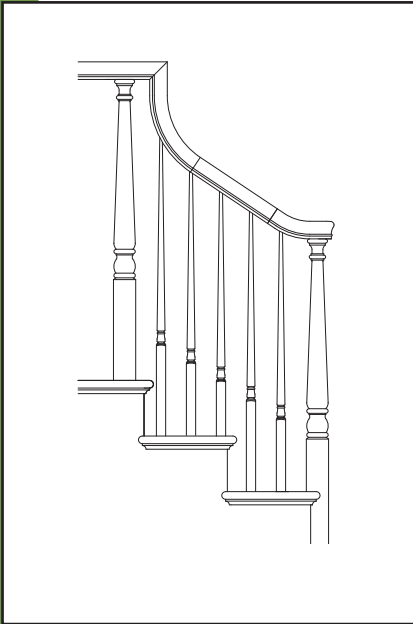

## 1 1/4" Balusters

### CONECT-A-KIT™ FITTINGS AVAILABLE

KLS6109



KLS6109PO  
2 7/8" x 2 3/8"

KLS6010



KLS6010P  
2 3/8" x 2 1/4"

KLS6601

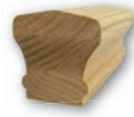

KLS6601P  
2 1/4" x 2 1/4"

### NO FITTINGS AVAILABLE



KLS6112  
2 3/8" x 2 1/4"

#### FILLET



KLS6050  
3/8" x 1 1/4"

#### SHOE RAIL



KLS6045  
3/4" x 2 1/2"

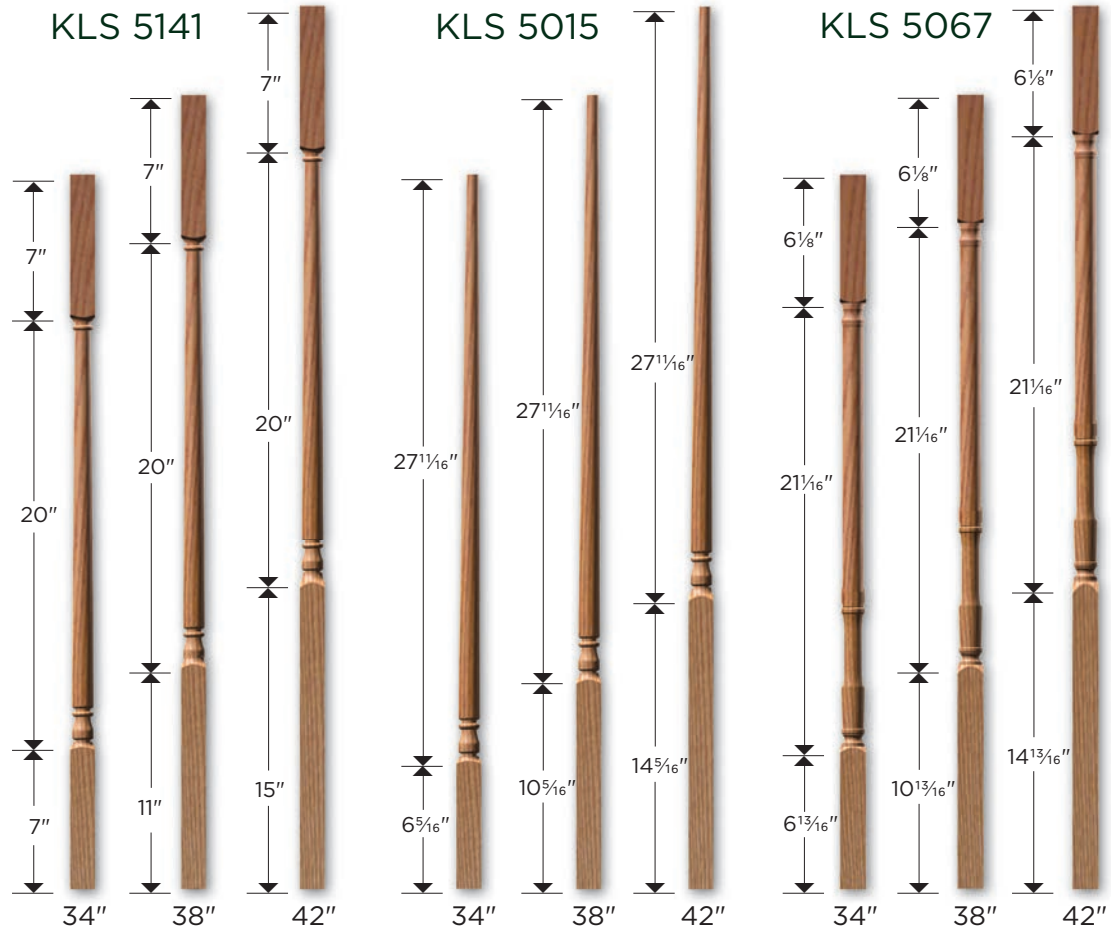

# Keim

# Newels

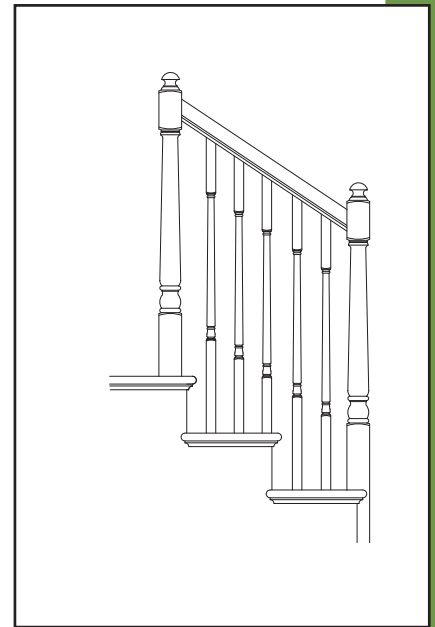
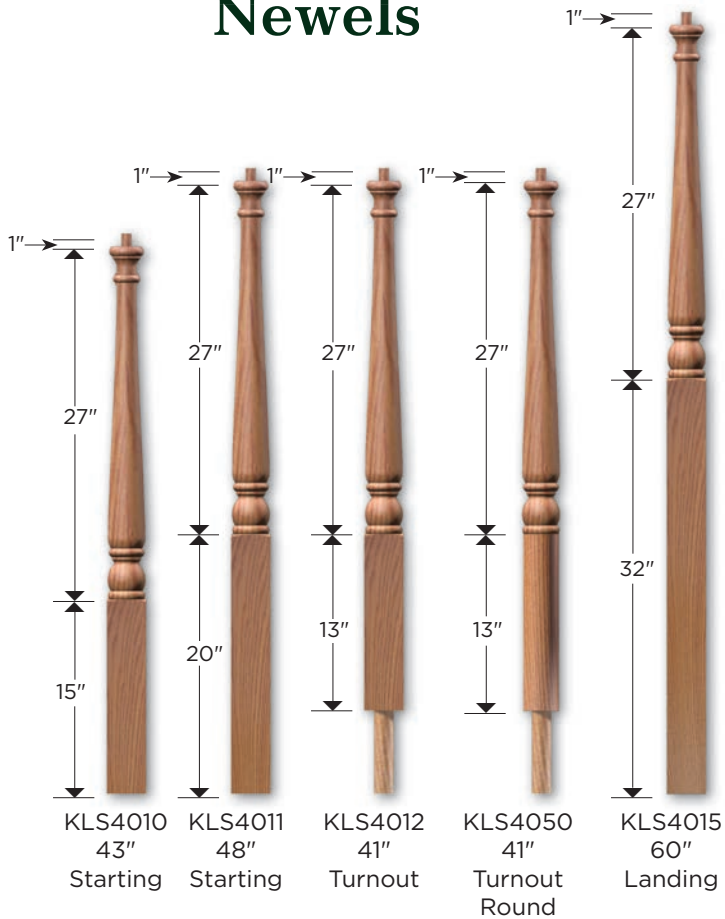

## 3" Newels

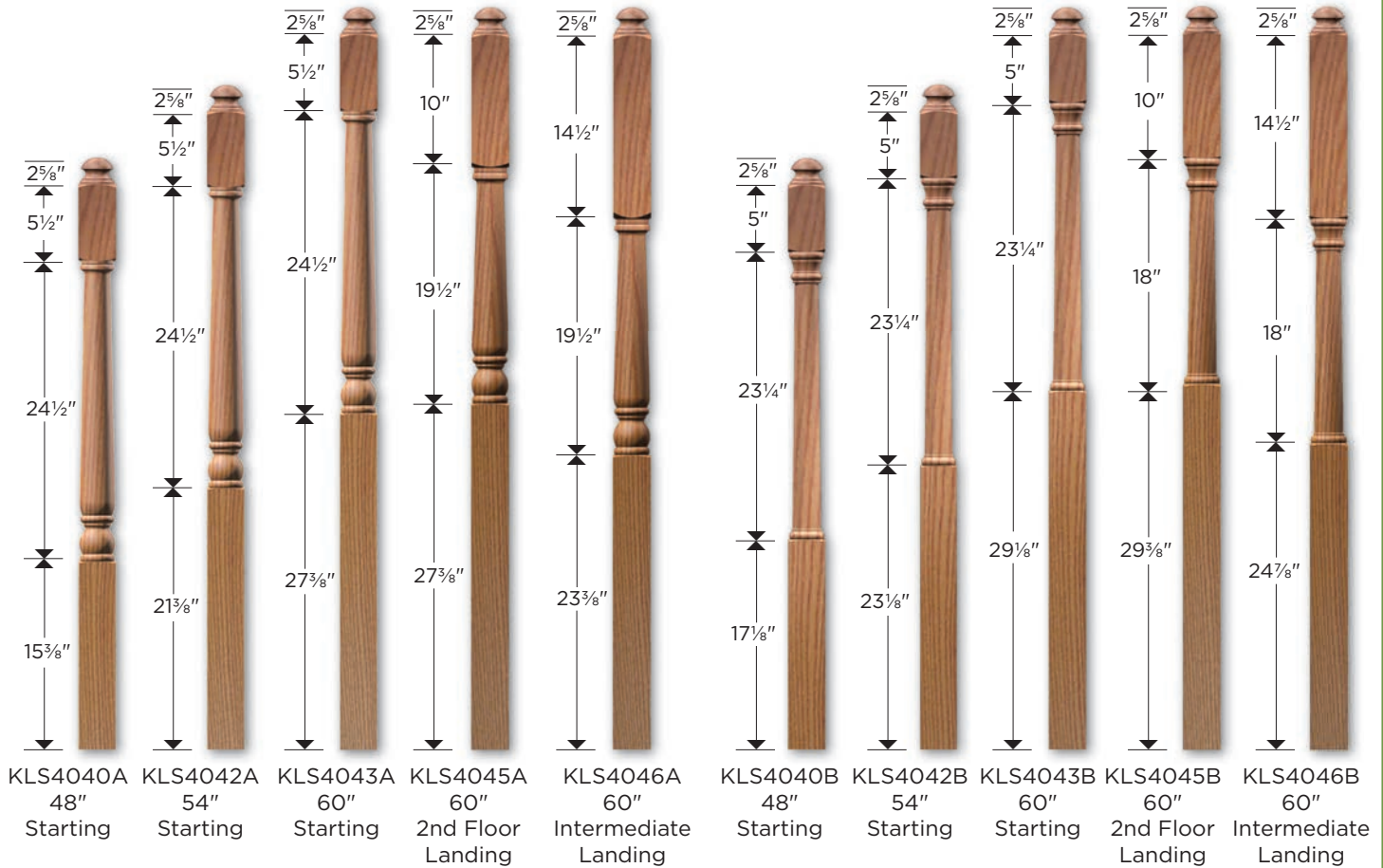

# Keim

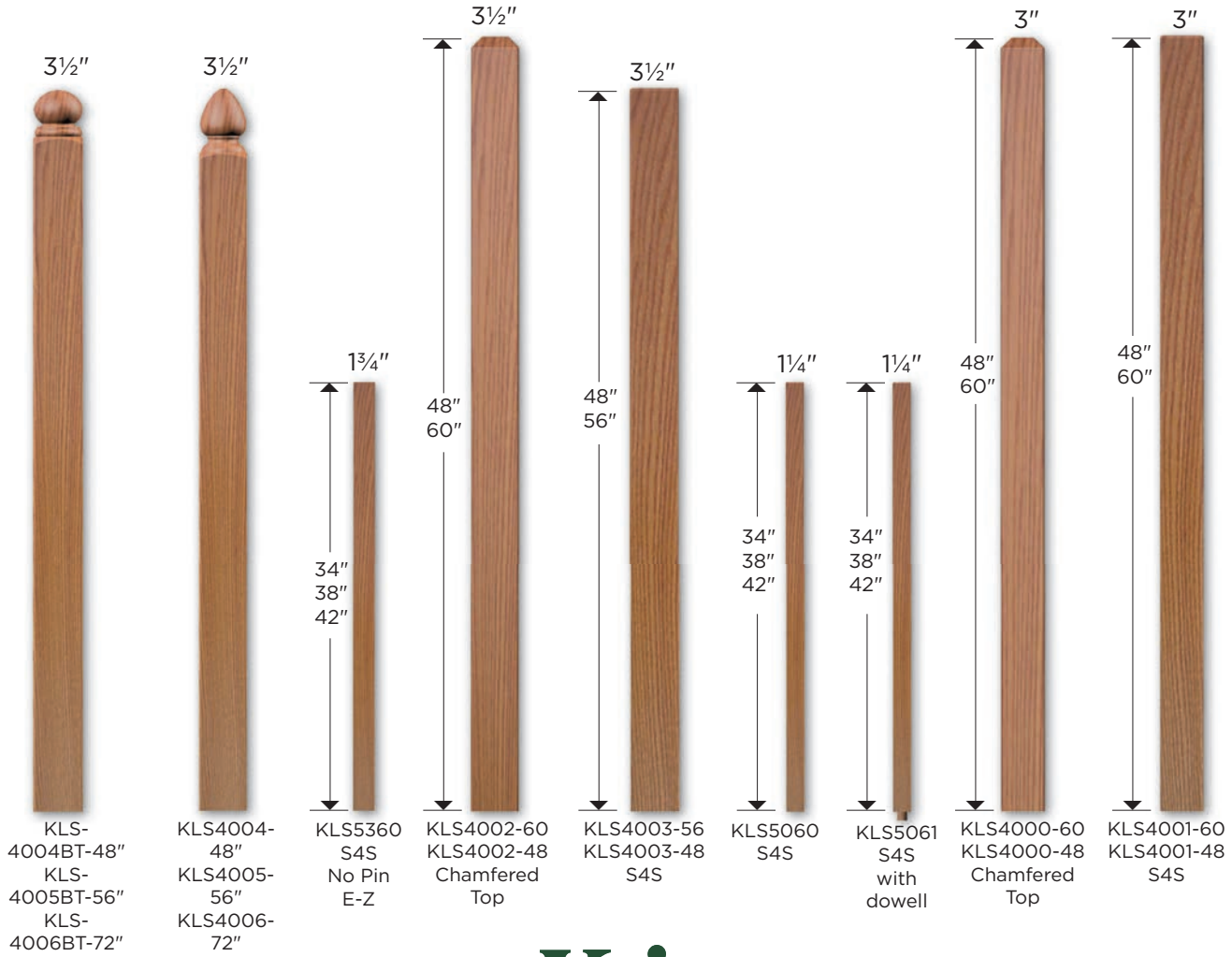
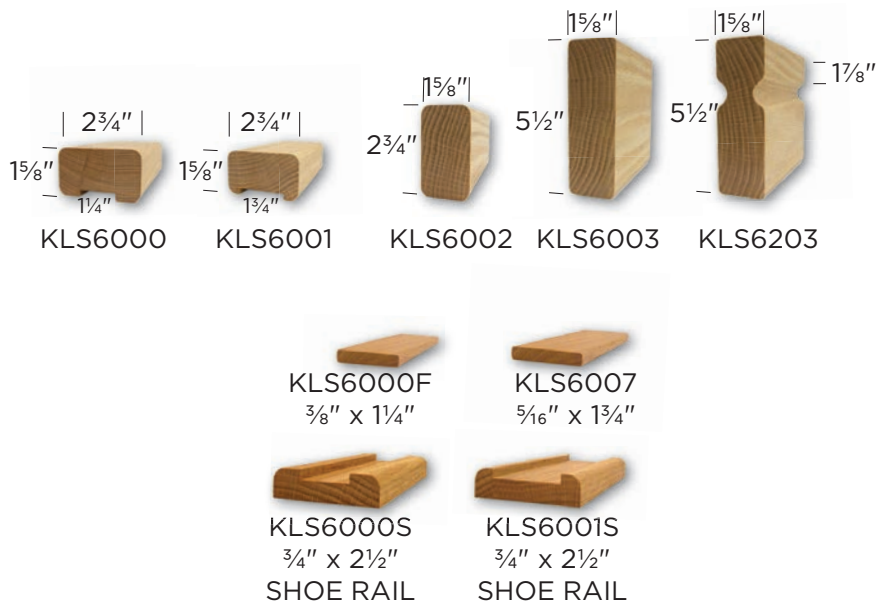
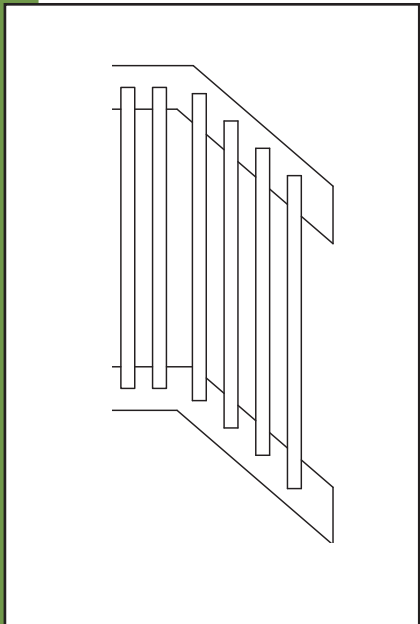

**Keim**

# Box Newels

Box newels are assembled using lock miter corners.

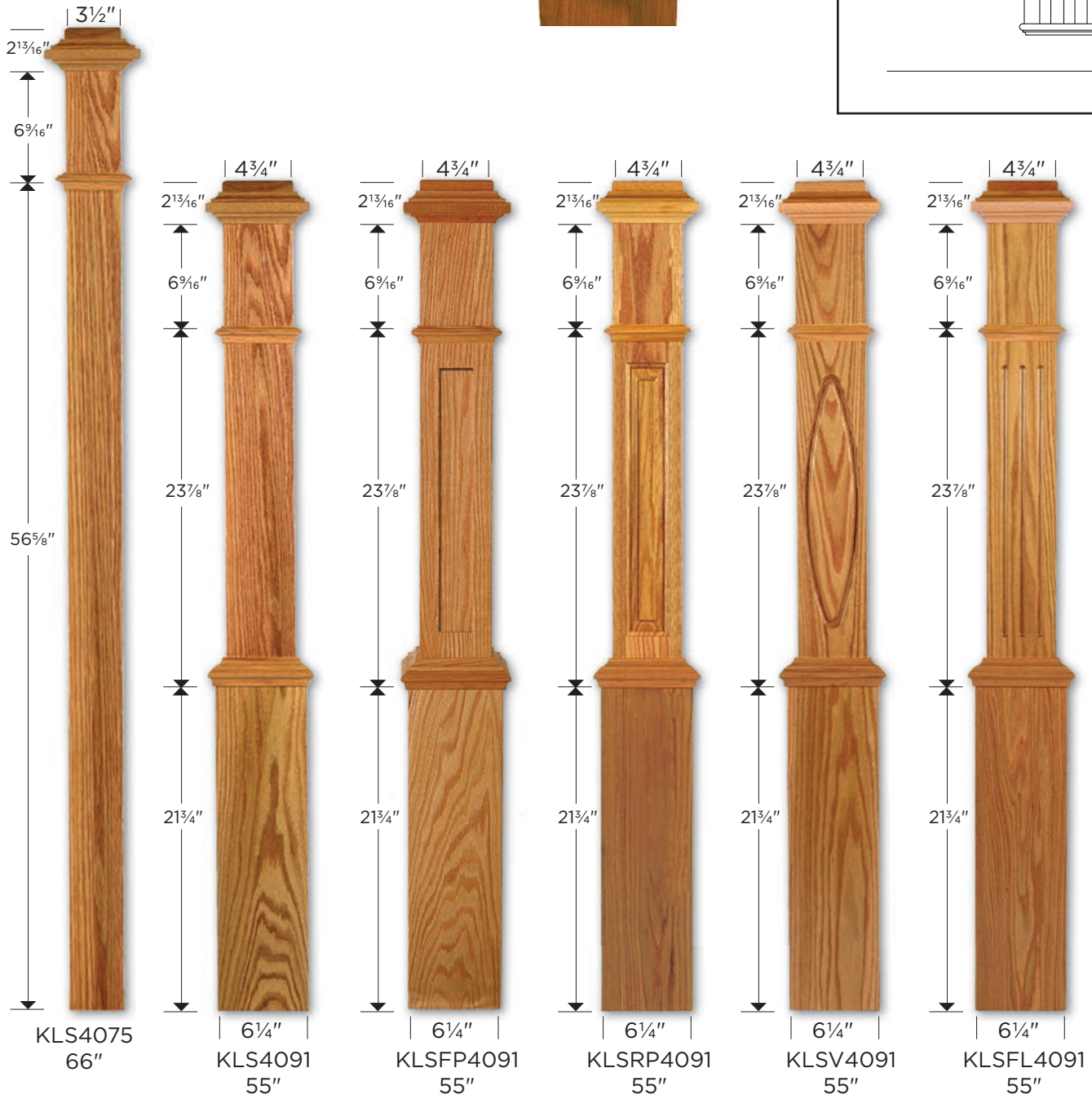
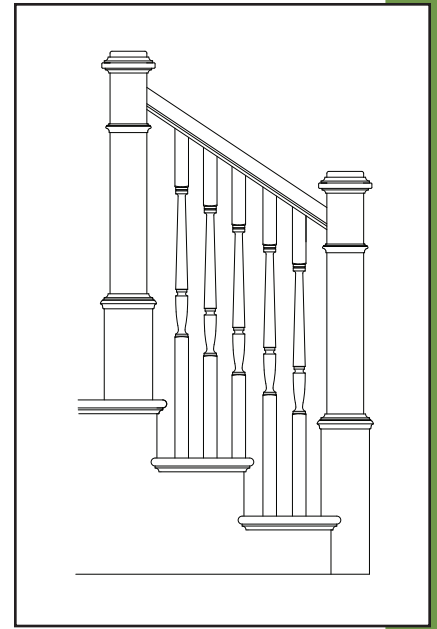
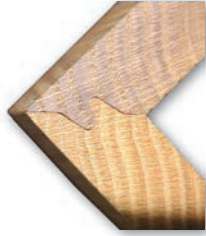

# Keim



KLS8015 radius R= 6 1/2" x= 10 1/2"  
 KLS8315 radius R= 7 1/4" x= 12 1/4"  
 Total Rise = 8 1/32"

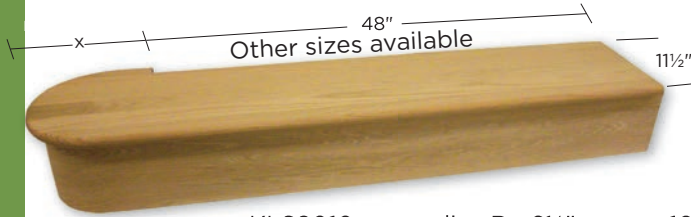

KLS8010 radius R= 6 1/2" x= 10 1/2"  
 KLS8310 radius R= 7 1/4" x= 12 1/4"  
 Total Rise = 8 1/32"

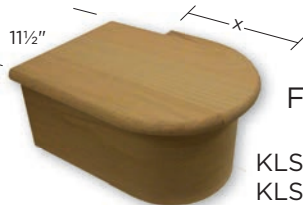

**FALSE END TREAD & RISER**

KLS8010-2 radius R= 6 1/2" x= 10 1/2"  
 KLS8310-2 radius R= 7 1/4" x= 12 1/4"  
 Total Rise = 8 1/32"

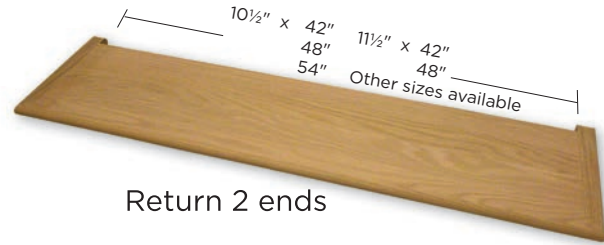

**Return 2 ends**

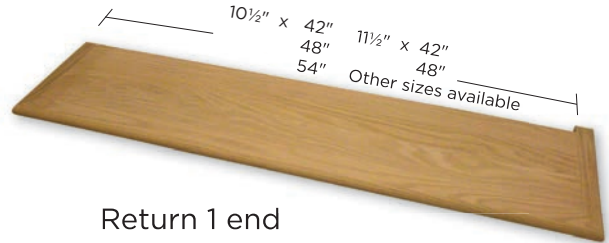

**Return 1 end**



**STAIR NOSING  
KL639**

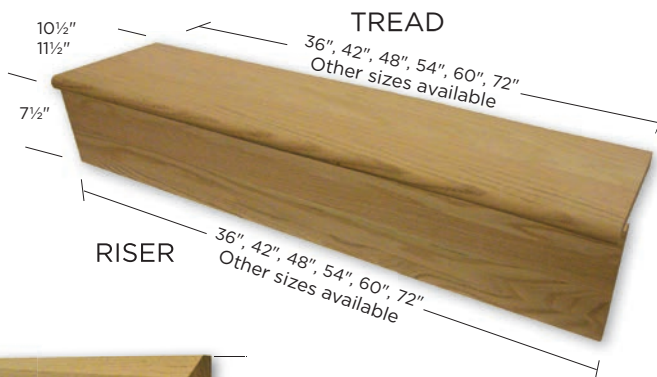

**KLS8079 Reversible  
FALSE TREAD & RISER KIT**  
 use for Left or Right  
 open or closed stair  
 Riser and Tread are one side oak,  
 one side paint grade

**Single end starting steps & treads  
should be ordered L or R.**

**All stair handing is determined  
while looking up the stairs.**

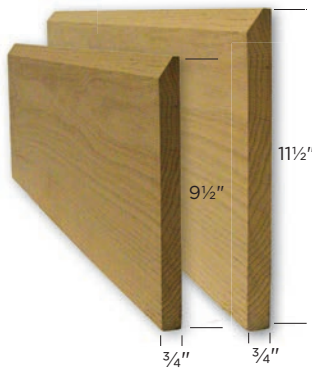

**SKIRT BOARD  
KL220**

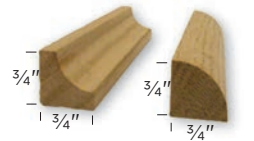

**KL303 KL705**

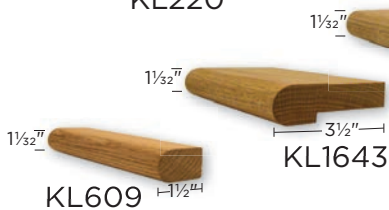

**KL609**

**KL1643**



**KL1645**  
 USE WITH 3 1/2" OR WIDER NEWELS



Starting steps come complete  
with tread, riser, cove, and shoe.

CLIMBING VOLUTE

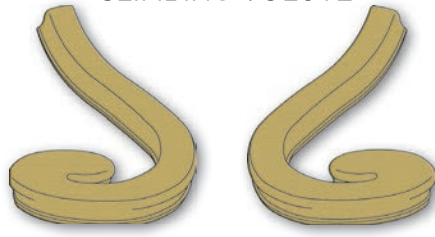

LJ7\_31 LJ7\_36

TURNOUT<sup>1</sup>  
CONNECT-A-KIT™



LJ7\_41 LJ7\_46

STARTING EASING  
CONNECT-A-KIT™

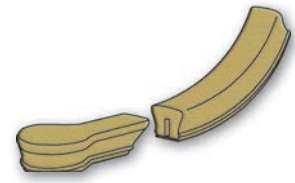

LJ7\_19 LJ7\_12

STANDARD VOLUTE  
CONNECT-A-KIT™

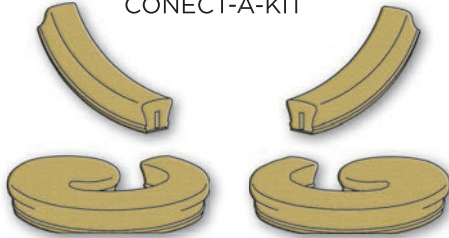

LJ7\_30 LJ7\_35

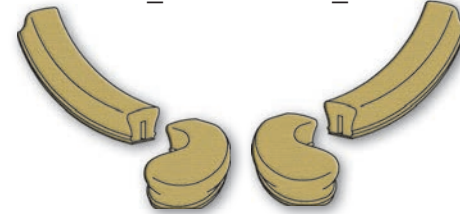

LJ7\_40 LJ7\_45

CLIMBING VOLUTE

STANDARD VOLUTE



Climbing volutes provide an attractive alternative to the extra long newel post on the starting step.

Climbing volutes are available in the following non-plowed profiles.



KLS6601 KLS6109 KLS6210



KLS6400 KLS6519 KLS6010

\* Use second digit of rail profile for fitting profile.

STEP/FITTING MATCH-UP	
STARTING FITTING	USE WITH STARTING STEP
6010, 6210, 6601 TURNOUT OR STANDARD VOLUTE	KLS8010
	KLS8010-2
	KLS8015
6519, 6400, 6109 TURNOUT OR STANDARD VOLUTE ALL CLIMBING VOLUTES	KLS8310
	KLS8310-2
	KLS8315
BOX NEWELS	KLS8030
	KLS8050



When using a climbing volute, the newel height at the volute will be approximately 4½" lower than what is produced with a standard volute.

<sup>1</sup> Use 1 baluster with 7\_41, 7\_46  
Use 2 balusters with 7\_40, 7\_45



Conect-A-Kit™ fittings have a base with machined pockets and a removable top lid for easy installation. All assembly hardware is concealed within the base of each fitting. Most of these fittings are manufactured with a precision miter cut on the end so they may be used in combination with other fitting components to build landing fittings. The mitered ends are easily square cut for attachment to straight handrail.



**Conect-A-Kit™ fittings offer:**  
Versatility, Ease of Assembly, and Added Strength.

## Straight Run Fitting Applications

\*Use second digit of rail profile for fitting profile.

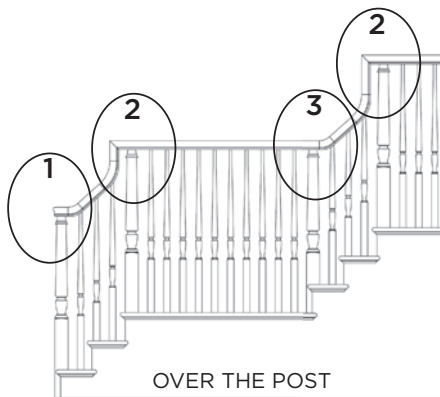

STRAIGHT RUN APPLICATIONS OVER THE POST				
	NEWEL	FITTINGS		
1	STARTING	7_19	7_12	
2	STARTING	7_12	7_RD	7_20
3	STARTING	7_20	7_12	

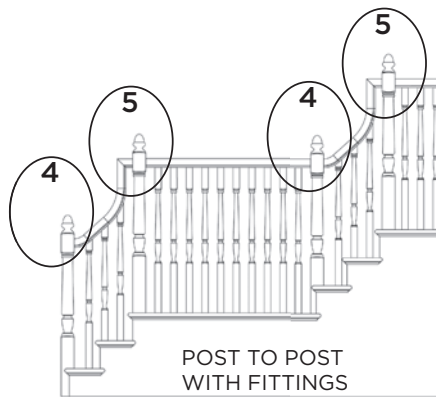

STRAIGHT RUN APPLICATIONS POST TO POST WITH FITTINGS				
	NEWEL	FITTINGS		
4	STARTING	7_12		
5	STARTING	7_12	7_RD	7_09

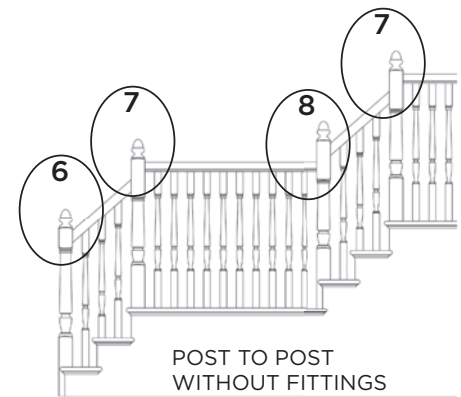

STRAIGHT RUN APPLICATIONS POST TO POST WITHOUT FITTINGS		
	NEWEL	FITTINGS
6	STARTING	N/A
7	BALCONY LANDING	N/A
8	BALCONY LANDING	N/A



**Keim**



# Rail Fittings

LJ Smith CONECT-A-KIT™ fittings are available for these profiles: KLS6010; KLS6109; KLS6210; KLS6400; KLS6519; KLS6601

Standard fittings are available for KLS6710 and KLS6910



7\_11 LEVEL ¼ TURN CONECT-A-KIT™

7\_09 RETURN END CONECT-A-KIT™



7\_RD RAIL DROP CONECT-A-KIT™



7\_12 UPEASING CONECT-A-KIT™



7\_14 UPEASING 90 CONECT-A-KIT™



7\_13 OVER EASING



7\_08 COPED END



7\_18 PLAIN CAP

## Turning Fitting Applications

\*Use second digit of rail profile for fitting profile.

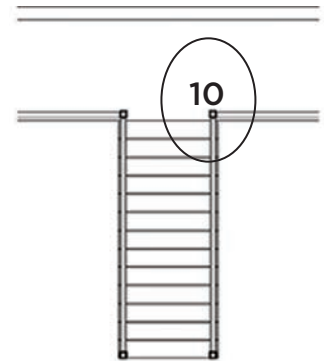
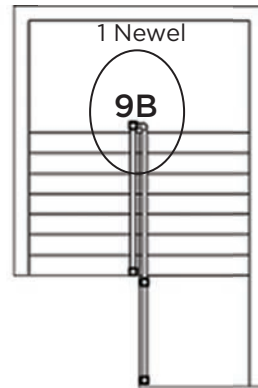
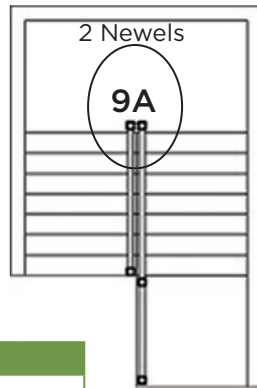
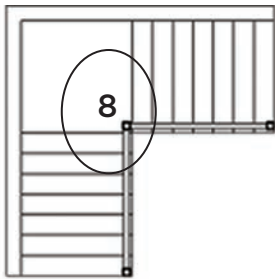

OVER THE POST						
	NEWEL	FITTINGS				
8	STARTING	7_12	7_RD	7_21	7_12	
9A	2 STARTING	7_12	7_RD	7_21	7_21	7_12
9B	STARTING	7_12	7_RD	7_21	7_11	7_12
10	STARTING	7_12	7_RD	7_21		

POST TO POST WITH FITTINGS						
	NEWEL	FITTINGS				
8	STARTING	7_12	7_RD	7_09	7_12	
9A	2 STARTING	7_12	7_RD	7_09	7_12	
9B	STARTING	7_12	7_RD	7_09	7_11	7_12
10	STARTING	7_12	7_RD	7_09		

POST TO POST WITHOUT FITTINGS	
	NEWEL
8	INTERMEDIATE LANDING
9A	2 INTERMEDIATE LANDING
10	2ND FLOOR LANDING

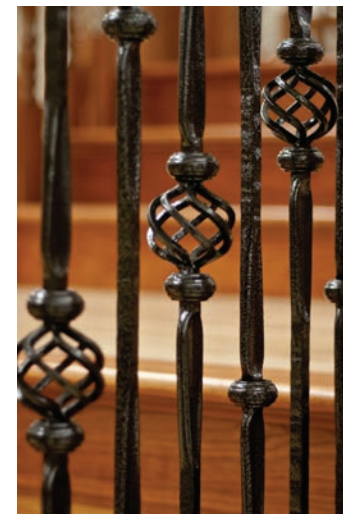

LJ Smith Conect-A-Kit™ Artwork  
©LJ Smith. used by permission

©2020 KEIM  
REVISED MAY 2020

# Keim

KEIMHOME.COM | 330.893.2251

## Brackets



KLS7028  
PLAIN BRACKET  
11½" x 8⅞" x ⅝"



KLS7029  
SCROLL BRACKET  
11½" x 8⅞" x ⅝"

## Rosettes



KLS7026  
4¾" x 4¾" x ¾"



KLS7027  
4⅞" x 6½" x ¾"



## Handrail Brackets

### V140

PEWTER  
SATIN NICKEL  
BRIGHT BRASS  
ANTIQUE BRASS  
BRIGHT CHROME  
OIL RUBBED BRONZE  
ANTIQUE BRONZE



### 59MB

BLACK  
PEWTER  
SATIN NICKEL  
SATIN CHROME  
ANTIQUE BRASS  
OIL RUBBED BRONZE



### V112

WHITE  
BLACK  
SATIN NICKEL  
PEWTER  
SATIN CHROME  
BRIGHT CHROME  
BRIGHT & ANTIQUE BRASS  
OIL RUBBED, AGED, & ANTIQUE BRONZE



**Custom Turning  
Available on tops**

**Call and request  
a quote.**

## Interchangeable finial or Ball top available for 4130 Series newels

all finials are ¾" wide - shipped unattached

5"



PA410



CA411

6"



PP412



RCP413



CP414



OCT415

4½"



PB416

## Wall Railing

Fittings Available



KLS6600  
2¼" x 2⅝"  
SOME FITTINGS AVAILABLE



KLS6040  
1⅝" x 1¾"



KLS6041  
2" x 2"



KLS6042  
1⅜" x 2¼"

No Fittings  
Available



KLS6039  
1¾" x 1¾"



KLS901  
1½" x 1½"



LJ7023



LJ7001



LJ7005



LJ7024



LJ7002

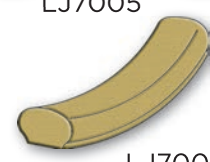

LJ7006



LJ7025



LJ7003

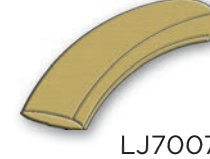

LJ7007

# Keim

LJ Smith Artwork  
©LJ Smith, used by permission

Creating a curved balustrade is accomplished using Keim's bending rail and wood or poly-vinyl bending mold. Available in several profiles, Keim's bending rail and bending mold make curved railing practical and affordable. The end product will match the standard rail profile.

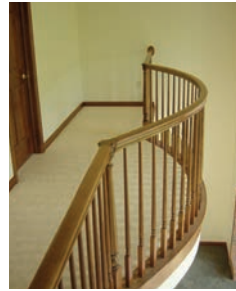

Keim offers stock, non-stock, and custom stair parts to satisfy the most discriminating taste. Keim has a number of "custom" profiles available or we can craft a design to your specifications. Keim offers a full line of domestic and exotic woods to make your stair system truly distinctive.

Our friendly, knowledgeable staff's goal is to provide the stair system you desire with elegance, quality, and beauty.



PROFILE	MINIMUM RADIUS LEVEL	MINIMUM RADIUS RAKE
KLS6010B	36"	30"
KLS6210B	36"	30"
KLS6519B	60"	54"
KLS6601B	36"	30"
KLS6710B	60"	54"
KLS6810B	36"	30"
KLS6910B	36"	30"
KLS6600B	36"	30"

## Custom



KLS1902



KLS925



KLS950



KLS999



KLS961



KLS997



PURPLE HEART HANDRAIL



CURVED RAIL & STAIR NOSING



EXOTIC WOODS



CUSTOM NEWEL

# Keim

# Installation Hardware

## Newel Mounting Kits

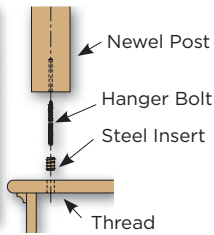

**LJ-3004**  
Newel Mounting Kit

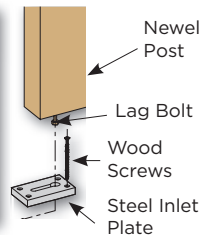

**LJ-3005**  
Keylock™ Newel Post Fastener

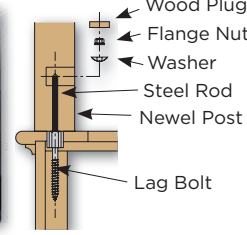

**LJ-3070**  
Threadlock™ Newel Post Fastener

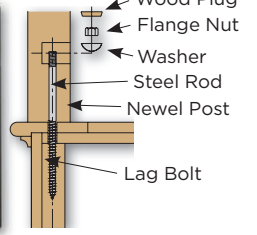

**LJ-3008**  
Sure-Tite™ Newel Fastening System

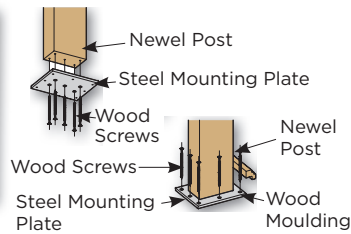

**LJ-3006**  
Newel Mounting Plate for 3" to 3½" newels



L-Bracket™ Newel Post Anchor  
**LJ-3009**  
for 3" newels

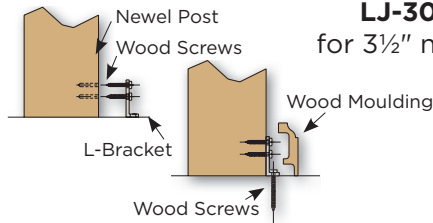

**LJ-3019**  
for 3½" newels

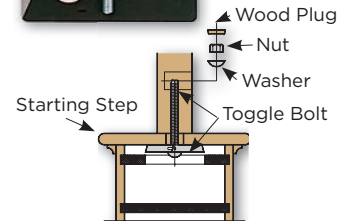

**LJ-3071**  
Toggle Bolt Newel Mounting Kit

## Miscellaneous Hardware

**LJ-3075**  
Flash Mount Kit

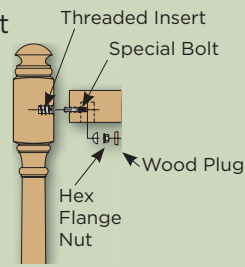

**LJ-3078**  
Rail & Post Fastener

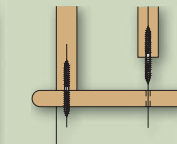
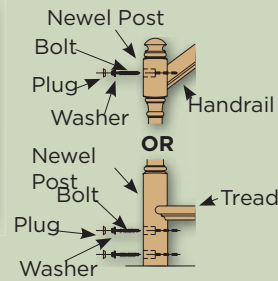

**LJ-3076** (50 Pack)  
Dowel Fast™



**LJ-3079**  
Rail Bolt  
**LJ-3080**  
(10 pack)

## Bore Buster®



**LJ-3060**  
Bore Buster®

# Installation Tools

## Handrail and Fitting Tools

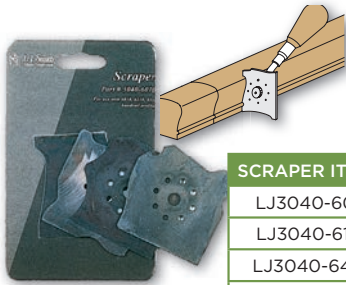

Scraper

SCRAPER ITEM #	HANDRAIL ITEM #
LJ3040-6010	KLS6010 - KLS6210
LJ3040-6109	KLS6109
LJ3040-6400	KLS6400
LJ3040-6519	KLS6519
LJ3040-6701	KLS6601



**LJ-3043**  
Scraper Handle



**LJ-3044**  
Versa Tool



**LJ-3037**  
Rail Fitting Level

## Chuck-Buster™ Tools



**LJ-3031**  
Chuck-Buster™



**LJ-3032**  
Rail Bolt-Runner™



**LJ-3033**  
Dowel Runner™



**LJ-3034**  
Screw-Runner™



**LJ-3085**  
Insert-Runner™



**LJ-3036**  
Dowel-Fast Tap™

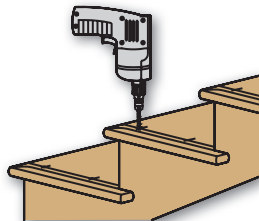

**LJ-3061**  
Bore Buster® Plus

## Baluster Marking and Installation Tools

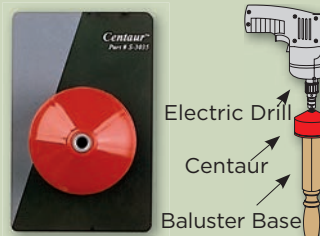

**LJ-3035**  
Centaur™

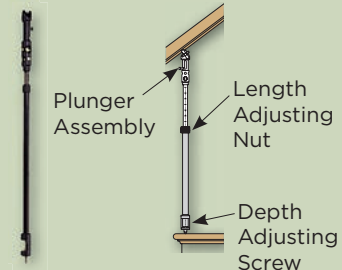

**LJ-3047**  
Telescoping Baluster  
Marking Tool

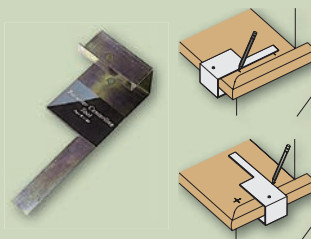

**C-88**  
Baluster  
Centerline  
Tool

# Keim

LJ Smith Artwork  
©LJ Smith, used by permission

©2020 KEIM  
REVISED MAY 2020

KEIMHOME.COM | 330.893.2251

# Stair System Planning Guide

## Building Codes

*rake rail height  
level rail height  
rise  
run*

*baluster spacing "sphere code"  
headroom  
tread width  
handrail projection & clearance*

## Stair Body

*open or closed system  
treads & risers  
starting step  
plain or mitered return  
full tread or false end  
cove & shoe  
tread brackets  
balcony nosing*



## Balusters

*profile and cross section  
rake balusters  
level balusters*

## Newels

*post to post or over the post  
profile and cross section  
starting  
intermediate landing  
balcony landing  
balcony intermediate*

## Rail System

*plain  
plowed  
bending  
bending mold  
fittings  
shoe rail  
fillet  
wall rail*

## Accessories

*newel mounting  
baluster mounting  
rosettes  
rail brackets  
installation tools*

## Ordering Guidelines

Use unplowed rail for pin top balusters

Use plowed rail for square top balusters

Use 5", 5¼", or 6½" top block newels for:

- starting newels
- balcony intermediate newels
- when using post to post rail with fittings

Use 10" top block newels when making the transition between level and rake railing

Use 14½" top block newels at a turn between two rake sections of railing.

Center to center spacing for balcony baluster; spacing with 4" rule:

- Use a maximum 4½" center to center spacing for all pin top balusters and 1¼" square top balusters.
- Use a maximum 4⅝" center to center spacing for 1¾" square top balusters.

## All Elegant-Rise Balusters

use Pin-EZ (included with balusters) and are predrilled at a depth to allow for trimming during installation. This will insure a quality fit and successful compliance with regional codes.



KLS7002  
PIN-EZ

Keim's friendly, knowledgeable staff will be happy to assist you in choosing the material you need to add beautiful, quality stairs to your home or project.

# Keim

# Rail Profiles



## Rail for 1 1/4" Balusters



## Contemporary Rail



# Baluster Designs

## 1 3/4" Balusters



## 1 1/4" Balusters

All newels are available in plain, octagon, fluted, and twist.

All balusters are available in plain, octagon, fluted, and twist.



Newels and balusters in the KLS2105 and KLS2115 series are also available in reeded.



## Post to Post

3 1/2"      3 1/4"



## Newel Designs

3"



## Over the Post

3 1/2"      3"



*Holmes County, Ohio—the heart of Amish country and an area renowned for the quality craftsmanship of its woodworkers—has been the home of Keim for four generations. Look for us at the same location where knowledgeable customers have found us for over a century, in Charm, Ohio.*

**Efficient Delivery Available**

**Competitive Nationwide Shipping**



P.O. Box 6, Charm, Ohio 44617  
Phone: 330.893.2251 | Toll Free: 800.362.6682  
[www.keimhome.com](http://www.keimhome.com)