



















































































































CUSTOM PROFILE TABLE OF CONTENTS Handrail

PROFILE	SIZE	PAGE	PROFILE	SIZE	PAGE	PROFILE	SIZE	PAGE			
KL 998		1.75 x 2.5	20	KL 1929P_6701P		2.125 x 2.750	28	KL 1965		1.500 x 5.500	35
KL 999		3.625 x 4.000	20	KL 1930P		3.500 x 8.000	28	KL 1966		1.250 x 5.250	36
KL 1900P		3.687 x 2.687	20	KL 1931P		3.500 x 8.000	29	KL 1967		1.750 x 4.500	36
KL 1901		2.000 x 3.000	20	KL 1932		3.250 x 2.625	28	KL 1968		1.250 x 4.500	36
KL 1902		2.375 x 2.875	21	KL 1933		2.094 x 2.750	28	KL 1969		1.750 x 3.250	35
KL 1902B		2.375 x 2.875	21	KL 1934P		2.812 x 4.668	30	KL 1970		1.625 x 3.000	36
KL 1903		.750 x 1.500	18	KL 1935		4.250 x 3.000	29	KL 1971		2.500 x 5.250	37
KL 1904		2.281 x 2.937	21	KL 1936		.750 x 2.500	27	KL 1972		1.500 x 5.500	37
KL 1905		2.375 x 2.875	21	KL 1937P		2.375 x 2.623	29	KL 1973		1.437 x 3.250	36
KL 1906B		1.625 x 2.750	21	KL 1938P		2.625 x 3.250	30	KL 1973P		1.437 x 3.250	37
KL 1906_6002		1.625 x 2.750	21	KL 1939P		1.500 x 2.625	30	KL 1974		1.437 x 2.500	36
KL 1906P		1.625 x 2.750	22	KL 1940P		4.000 x 3.750	31	KL 1975		1.750 x 4.000	38
KL 1907		3.504 x 7.500	22	KL 1941P		2.125 x 1.500	30	KL 1976		1.512 x 2.625	37
KL 1908P		.750 x 3.250	22	KL 1943		1.562 x 5.500	30	KL 1977		2.375 x 2.625	38
KL 1909P		.750 x 3.250	22	KL 1944		4.509 x 10.513	31	KL 1978P		3.500 x 5.000	38
KL 1910P		.750 x 2.500	22	KL 1945		1.000 x 5.500	31	KL 1979P		2.750 x 2.750	39
KL 1911P		3.450 x 3.375	23	KL 1946P		1.750 x 2.750	31	KL 1980P		2.886 x 3.000	39
KL 1912P		1.000 x 3.437	23	KL 1947P		1.750 x 2.750	32	KL 1981		1.375 x 4.375	37
KL 1913		.687 x 1.437	21	KL 1948		3.000 x 3.000	32	KL 1982		2.500 x 7.500	40
KL 1914		5.500 x 7.000	24	KL 1949		1.500 x 5.500	32	KL 1983P		2.625 x 2.000	38
KL 1915		5.500 x 7.000	25	KL 1950P		.687 x 2.000	29	KL 1984P		3.000 x 3.500	39
KL 1916		1.500 x 5.500	23	KL 1951		1.748 x 7.000	33	KL 1985		2.079 x 1.716	37
KL 1917		2.250 x 3.030	23	KL 1952P		1.922 x 2.000	32	KL 1985P		2.079 x 1.730	38
KL 1918		2.650 x 2.325	22	KL 1953P		2.312 x 3.062	32	KL 1986P		.750 x 2.375	37
KL 1919		1.562 x 5.500	24	KL 1954P		1.375 x 1.250	30	KL 1987P		2.500 x 2.500	39
KL 1920		3.200 x 4.421	26	KL 1955P		1.750 x 5.000	34	KL 1988P		1.125 x 3.000	38
KL 1921P		4.000 x 4.125	26	KL 1956		1.500 x 1.500	31	KL 1989		1.750 x 3.375	39
KL 1922		1.500 x 5.437	25	KL 1956B		1.500 x 1.500	31	KL 1990		.875 x 2.500	39
KL 1923A		1.537 x 2.230	23	KL 1957P		2.500 x 2.625	33	KL 1991P		1.500 x 2.500	40
KL 1923B		1.213 x 2.500	23	KL 1958P		1.000 x 2.625	33	KL 1992P		1.500 x 2.750	40
KL 1924		1.250 x 3.250	27	KL 1959		3.375 x 4.562	33	KL 1993P		1.500 x 2.750	40
KL 1925		2.375 x 2.250	26	KL 1960		1.000 x 2.360	34	KL 1994		1.500 x 3.000	41
KL 1926		3.625 x 2.625	26	KL 1961B		2.312 x 2.375	34	KL 1995		2.250 x 3.375	40
KL 1926P		3.625 x 2.625	27	KL 1961P_6B10P		2.312 x 2.374	34	KL 1996		2.000 x 4.000	41
KL 1927P		1.000 x 2.625	27	KL 1961_6B10		2.312 x 2.375	34	KL 1996P		2.000 x 4.000	41
KL 1928		2.750 x 3.250	27	KL 1962P		1.000 x 4.250	35	KL 1997B		1.359 x 1.500	38
KL 1928P		2.750 x 3.250	27	KL 1963P		2.000 x 5.000	35	KL 1997		1.359 x 1.500	41
KL 1929_6701		2.125 x 2.750	27	KL 1964P		1.750 x 2.625	35	KL 1997P		1.359 x 1.500	41

CUSTOM PROFILE TABLE OF CONTENTS Handrail

PROFILE	SIZE	PAGE	PROFILE	SIZE	PAGE	PROFILE	SIZE	PAGE
KL 3980		3.625 x 4.500 61	KL 4914		2.750 x 3.250 68	KL 4948P		2.250 x 5.500 76
KL 3981		2.625 x 2.625 61	KL 4914 P		2.750 x 3.250 69	KL 4950		3.625 x 2.625 76
KL 3981B		2.625 x 2.625 62	KL 4915P		3.500 x 4.000 69	KL 4951		1.625 x 2.750 74
KL 3982P		1.406 x 3.500 62	KL 4916P		1.500 x 4.000 67	KL 4952		2.000 x 2.750 74
KL 3983		2.250 x 3.500 62	KL 4917P		3.000 x 4.000 70	KL 4953		3.218 x 2.625 77
KL 3983B		2.250 x 3.500 62	KL 4918P		2.062 x 2.250 67	KL 4954		1.531 x 2.250 73
KL 3984		1.875 x 2.500 60	KL 4919		1.078 x 3.000 68	KL 4955		1.750 x 2.750 75
KL 3985P		3.062 x 2.750 62	KL 4920		1.812 x 3.250 68	KL 4956		2.500 x 2.750 76
KL 3986		2.500 x 3.500 62	KL 4921		1.562 x 2.750 69	KL 4956P		2.500 x 2.750 76
KL 3988P		2.500 x 3.000 63	KL 4921P		1.687 x 2.750 69	KL 4957		2.623 x 2.875 77
KL 3989		1.250 x 3.000 63	KL 4922P		1.375 x 2.750 69	KL 4958P		2.689 x 2.750 77
KL 3990		4.000 x 2.625 63	KL 4923		2.125 x 2.500 69	KL 4959		2.250 x 2.625 77
KL 3991		1.421 x 2.625 63	KL 4924P		2.250 x 2.750 70	KL 4960P		2.312 x 2.250 74
KL 3991P		1.421 x 2.625 63	KL 4925P		3.750 x 2.688 70	KL 4961		2.000 x 3.500 77
KL 3992P		2.000 x 4.500 63	KL 4926		2.438 x 3.500 71	KL 4961B		2.000 x 3.500 78
KL 3993P		2.000 x 2.250 61	KL 4927P		2.750 x 2.750 71	KL 4962P		3.650 x 3.250 78
KL 3994		1.500 x 5.437 64	KL 4928P		2.750 x 2.750 71	KL 4963P		2.000 x 3.250 78
KL 3995		4.500 x 2.750 64	KL 4930P		2.750 x 3.000 71	KL 4964		1.500 x 5.500 75
KL 3995P		4.500 x 2.750 64	KL 4931P		2.750 x 3.500 72	KL 4965		1.750 x 2.375 78
KL 3996		.875 x 2.250 61	KL4931B		2.750 x 3.500 72	KL 4966		1.500 x 5.500 79
KL 3997		1.500 x 5.500 64	KL 4932P		2.750 x 4.500 72	KL 4967		3.500 x 3.125 78
KL 3998		1.750 x 2.750 65	KL 4932B		2.750 x 4.500 73	KL 4968		1.750 x 2.625 79
KL 3999		1.750 x 2.250 63	KL 4933		1.250 x 2.000 70	KL 4968P		1.750 x 2.625 79
KL 4900		3.500 x 2.625 65	KL 4935		1.750 x 2.750 71	KL 4969		1.562 x 5.437 79
KL 4900P		3.500 x 2.625 65	KL 4936		1.375 x 2.875 70	KL 4970		1.807 x 2.750 79
KL 4901		5.000 x 3.000 66	KL 4937		1.500 x 3.000 70	KL 4971P		1.813 x 2.500 79
KL 4902		1.437 x 2.625 65	KL 4938P		1.500 x 3.500 72	KL 4972P		1.813 x 2.500 80
KL 4903		3.500 x 2.250 65	KL 4939		3.312 x 3.000 73	KL 4973		2.375 x 2.250 80
KL 4904		3.375 x 1.875 66	KL 4940P		1.812 x 3.250 73	KL 4973B		2.375 x 2.250 80
KL 4905P		2.500 x 3.563 66	KL 4941P		2.375 x 4.500 74	KL 4974		1.750 x 2.500 80
KL 4906P		2.625 x 3.187 67	KL 4942		.562 x 2.484 72	KL 4975P		1.000 x 3.000 80
KL 4908		2.375 x 1.750 67	KL 4943P		1.625 x 2.625 73	KL 4976P		1.000 x 2.500 77
KL 4909P		2.500 x 2.500 67	KL 4944		2.250 x 2.625 74	KL 4977		.250 x 1.750 78
KL 4910		2.750 x 3.250 67	KL 4944B		2.250 x 2.625 74	KL 4978		2.625 x 3.062 80
KL 4911P		1.500 x 2.000 66	KL 4945		3.062 x 3.938 75	KL 4978P		2.625 x 3.062 81
KL 4912		2.500 x 3.250 68	KL 4945P		3.062 x 3.938 75	KL 4979P		1.125 x 2.000 78
KL 4913P		2.250 x 2.625 68	KL 4946		2.750 x 3.250 76	KL 4980P		3.125 x 3.688 81
KL 4914B		2.750 x 3.250 68	KL 4947		2.256 x 2.646 75	KL 4981B		1.750 x 2.625 81

CUSTOM PROFILE TABLE OF CONTENTS Handrail





















PROFILE		SIZE	PAGE	PROFILE		SIZE	PAGE	PROFILE		SIZE	PAGE
KL 4983		1.750 x 2.750	81	KL 5917P		1.500 x 2.000	87	KL 5951P		1.563 x 2.750	95
KL 4984		2.203 x 2.453	81	KL 5918		3.750 x 3.500	89	KL 5952P		1.562 x 2.750	95
KL 4985		1.719 x 3.500	81	KL 5919P		1.750 x 2.750	88	KL 5953		1.562 x 2.750	95
KL 4986P		2.250 x 5.250	82	KL 5920		1.500 x 2.250	88	KL 5954P		3.000 x 3.000	95
KL 4987		3.250 x 3.000	82	KL 5921P		4.000 x 5.750	90	KL 5955		2.375 x 3.000	95
KL 4988		2.687 x 3.062	82	KL 5922P		2.000 x 3.250	89	KL 5955P		2.375 x 3.000	95
KL 4989		2.750 x 2.750	83	KL 5923		1.875 x 3.000	89	KL 5956		3.375 x 3.500	96
KL 4989P		2.750 x 2.750	83	KL 5924P		1.563 x 2.750	89	KL 5957		1.875 x 2.750	96
KL 4990		2.250 x 2.531	82	KL 5925P		1.860 x 2.000	90	KL 5957P		1.875 x 2.750	96
KL 4991P		3.343 x 3.500	83	KL 5926		2.765 x 3.015	90	KL 5958P		1.563 x 2.750	96
KL 4992P		1.750 x 2.750	82	KL 5927		1.625 x 2.750	89	KL 5959P		1.500 x 2.250	96
KL 4993P		1.750 x 3.125	83	KL 5928		1.500 x 2.000	89	KL 5960		2.250 x 2.750	96
KL 4994P		1.687 x 2.750	83	KL 5928B		1.875 x 2.000	91	KL 5960P		2.250 x 2.750	97
KL 4994B		1.683 x 2.750	84	KL 5929		3.100 x 2.661	91	KL 5961P		2.000 x 5.000	97
KL 4995		1.500 x 5.062	84	KL 5930		1.437 x 4.000	91	KL 5962P		1.250 x 3.000	96
KL 4996		2.250 x 1.500	82	KL 5933P		3.062 x 2.750	91	KL 5963		2.400 x 3.031	97
KL 4997		2.000 x 3.500	84	KL 5934P		1.281 x 2.250	88	KL 5964		3.000 x 3.625	97
KL 4998		1.281 x 2.500	83	KL 5935		1.625 x 2.000	90	KL 5965		1.813 x 2.625	97
KL 4999P		3.125 x 2.500	84	KL 5935P		1.625 x 2.000	91	KL 5966		2.000 x 5.000	98
KL 5900P		2.000 x 3.062	85	KL 5936B		1.187 x 1.125	91	KL 5967P		1.000 x 2.250	98
KL 5901P		2.125 x 2.750	85	KL 5936		2.375 x 2.250	92	KL 5968P		1.750 x 2.640	98
KL 5902		3.125 x 5.000	85	KL 5936P		2.375 x 2.250	92	KL 5969P		1.781 x 3.313	98
KL 5903P		2.625 x 2.500	86	KL 5937P		.812 x 2.687	90	KL 5970		3.437 x 3.688	99
KL 5904B		2.500 x 3.031	86	KL 5938P		.813 x 2.813	91	KL 5970P		3.437 x 3.688	99
KL 5904		2.500 x 3.031	86	KL 5939		2.250 x 4.438	92	KL 5971		2.125 x 2.500	98
KL 5905		2.000 x 5.000	85	KL 5940		2.750 x 4.000	92	KL 5972		2.250 x 3.391	100
KL 5906P		1.625 x 2.750	84	KL 5941P		2.000 x 4.500	93	KL 5973		2.343 x 2.218	99
KL 5907		2.375 x 2.750	86	KL 5942		2.750 x 3.000	93	KL 5974P		1.625 x 2.625	99
KL 5908P		2.200 x 2.980	86	KL 5942P		2.750 x 3.000	93	KL 5975P		2.719 x 2.234	99
KL 5909P		1.750 x 4.000	86	KL 5943		2.250 x 2.250	92	KL 5976P		2.400 x 6.500	100
KL 5910		2.750 x 3.750	87	KL 5944		3.750 x 3.500	94	KL 5977		2.750 x 2.500	100
KL 5911		3.625 x 3.690	87	KL 5944P		3.750 x 3.500	94	KL 5977P		2.750 x 2.500	100
KL 5912P		3.937 x 4.187	88	KL 5944B		3.750 x 3.500	94	KL 5978		2.375 x 3.375	101
KL 5913P		2.187 x 3.312	88	KL 5945P		1.625 x 2.625	93	KL 5979		1.500 x 5.500	101
KL 5914		2.375 x 3.500	88	KL 5946P		1.333 x 1.562	92	KL 5980		2.000 x 3.500	101
KL 5914P		2.375 x 3.500	89	KL 5948		1.375 x 2.750	93	KL 5981P		3.312 x 3.250	101
KL 5915P		2.375 x 2.250	87	KL 5949P		1.000 x 2.125	93	KL 5982		3.850 x 2.850	102
KL 5916P		2.500 x 2.875	87	KL 5950		3.375 x 2.375	94	KL 5983P		2.500 x 3.250	101

CUSTOM PROFILE TABLE OF CONTENTS **Handrail**

PROFILE		SIZE	PAGE	PROFILE		SIZE	PAGE	PROFILE		SIZE	PAGE
KL 7984P		4.000 x 3.000	136	KL 9917		2.688 x 4.437	142	KL 9952P		2.250 x 2.625	149
KL 7985P		1.875 x 2.500	135	KL 9918		2.750 x 3.000	143	KL 9953		1.875 x 2.750	149
KL 7986P		3.500 x 3.500	136	KL 9919 P		3.562 x 3.313	143	KL 9954P		1.500 x 2.250	149
KL 7987P		1.625 x 2.750	136	KL 9919B		2.500 x 3.500	143	KL 9955		1.562 x 2.750	149
KL 7988		1.750 x 1.500	133	KL 9920 P		1.125 x 1.750	142	KL 9956		2.625 x 2.625	149
KL 7988P		1.750 x 1.500	134	KL 9921		1.750 x 2.500	142	KL 9957		1.500 x 2.250	150
KL 7989		2.250 x 2.750	136	KL 9921B		1.750 x 2.500	143	KL 9958		2.140 x 4.475	150
KL 7990		2.312 x 2.625	137	KL 9922		1.250 x 4.750	144	KL 9959		1.500 x 2.250	150
KL 7991		2.750 x 6.250	137	KL 9923P		1.625 x 2.500	144	KL 9960P		3.000 x 7.000	150
KL 7991P		2.750 x 6.250	138	KL 9924P		1.469 x 2.250	142	KL 9961P		4.000 x 4.750	151
KL 7992		1.718 x 2.625	136	KL 9925		3.437 x 2.406	144	KL 9962P		2.125 x 2.750	151
KL 7993		2.250 x 3.250	137	KL 9926P		3.000 x 2.375	144	KL 9963		2.750 x 3.500	151
KL 7994 P		2.125 x 2.250	137	KL 9927		2.281 x 4.219	144	KL 9964		1.750 x 4.380	152
KL 7995P		2.687 x 3.500	138	KL 9928P		2.101 x 2.500	145	KL 9965P		1.624 x 2.625	152
KL 7996P		1.938 x 2.750	137	KL 9929P		2.500 x 4.000	145	KL 9966		2.062 x 4.500	152
KL 7997		2.500 x 2.750	138	KL 9930		.813 x 3.000	143	KL 9967		1.875 x 2.625	153
KL 7997P		2.500 x 2.750	139	KL 9931		1.625 x 2.500	145	KL 9968P		2.000 x 2.000	151
KL 7998		2.250 x 2.250	138	KL 9932		2.750 x 3.750	145	KL 9970		2.500 x 2.750	153
KL 7999		1.875 x 2.625	138	KL 9932P		2.750 x 3.750	146	KL 9971		2.313 x 2.750	153
KL 9900P		3.250 x 4.625	139	KL 9933		2.500 x 5.625	146	KL 9972		2.269 x 3.188	153
KL 9901		2.750 x 4.500	140	KL 9934		2.500 x 3.625	147	KL 9973P		2.563 x 2.937	153
KL 9902		3.000 x 2.750	140	KL 9935		1.844 x 2.469	145	KL 9974P		1.500 x 2.500	151
KL 9903		2.187 x 2.750	139	KL 9936		1.875 x 3.250	145	KL 9975P		3.250 x 3.125	154
KL 9904		2.875 x 2.250	139	KL 9937P		2.500 x 3.500	147	KL 9976		1.500 x 3.000	152
KL 9905		1.875 x 3.188	139	KL 9938		1.938 x 3.250	146	KL 9977P		2.250 x 2.375	152
KL 9905B		2.500 x 3.500	140	KL 9939		2.125 x 2.938	146	KL 9978		1.625 x 2.625	153
KL 9906		2.250 x 3.750	140	KL 9940		1.438 x 2.625	146	KL 9979P		2.243 x 2.500	154
KL 9907		1.625 x 4.500	141	KL 9941		2.750 x 2.750	147	KL 9980P		1.875 x 2.813	154
KL 9908		2.562 x 2.625	141	KL 9942		2.300 x 2.250	147	KL 9981		2.031 x 3.000	154
KL 9909		3.125 x 6.000	141	KL 9943P		2.125 x 4.125	147	KL 9982		2.125 x 2.625	154
KL 9910P		1.562 x 2.250	140	KL 9944		1.688 x 3.500	148	KL 9983		2.385 x 5.056	155
KL 9910		1.562 x 2.250	139	KL 9945		1.250 x 2.250	145	KL 9984		1.563 x 3.500	152
KL 9911		2.250 x 5.000	142	KL 9946P		2.375 x 3.844	148	KL 9985		1.779 x 8.236	156
KL 9912		2.625 x 4.031	142	KL 9947		1.687 x 2.000	148	KL 9986		2.438 x 2.229	155
KL 9913		1.375 x 3.500	141	KL 9948		3.250 x 2.625	148	KL 9987		2.375 x 3.438	155
KL 9914		1.328 x 2.750	140	KL 9949		2.500 x 2.750	148	KL 9988		2.563 x 2.688	155
KL 9915		1.500 x 2.750	142	KL 9950		2.250 x 2.250	148	KL 9989		2.125 x 2.625	154
KL 9916		1.500 x 2.250	141	KL 9951P		2.500 x 2.750	149	KL 9990		1.476 x 1.500	154



CUSTOM PROFILE TABLE OF CONTENTS Handrail

PROFILE	SIZE	PAGE	PROFILE	SIZE	PAGE	PROFILE	SIZE	PAGE
KL 9991P		1.750 x 2.750	155					
KL 9992		2.000 x 3.500	156					
KL 9993		4.000 x 2.875	156					
KL 9995P		3.063 x 2.887	157					
KL 9996P		1.900 x 2.463	157					
KL 9997		2.875 x 2.250	157					
KL 9998P		.875 x 2.250	156					
KL 9999		1.784 x 5.906	158					
KL 11900		2.688 x 4.500	157					
KL 11901P		2.750 x 2.750	158					
KL 11902		3.000 x 3.000	158					
KL 11903P		1.812 x 2.625	157					
KL 11904		1.750 x 5.500	158					
KL 11905		2.125 x 2.625	159					
KL 11906		2.375 x 2.625	159					
KL 11907		1.313 x 2.250	156					
KL 11908		2.250 x 2.500	159					
KL 11909		2.250 x 2.500	159					
KL 11910		1.532 x 2.250	157					
KL 11912P		1.750 x 2.609	159					
KL 11913		3.000 x 2.719	159					

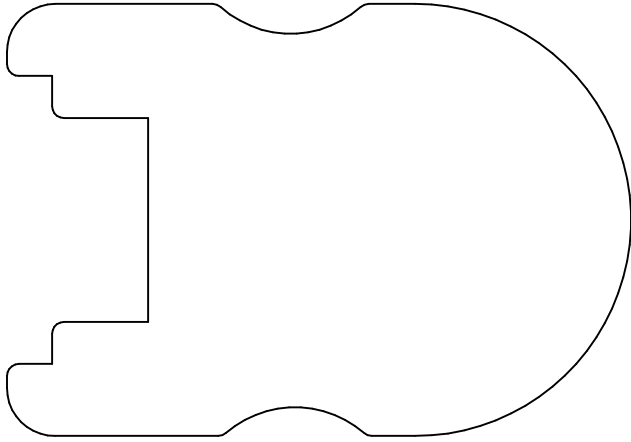

KL 902P
3.250 x 2.250

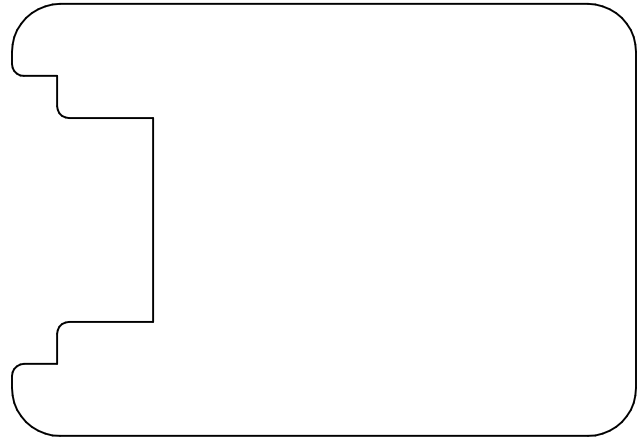

KL 903P
3.250 x 2.250

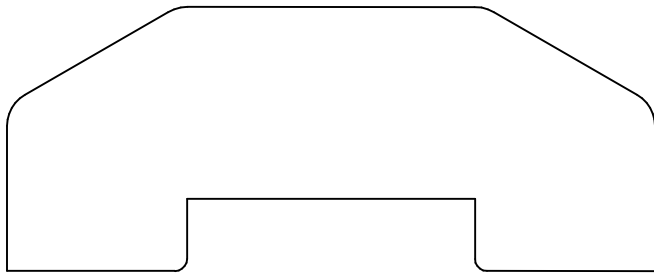

KL 904P
1.375 x 3.375



KL 905
.687 x 1.437

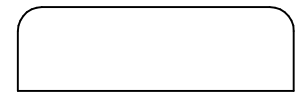

KL 906
.437 x 1.437

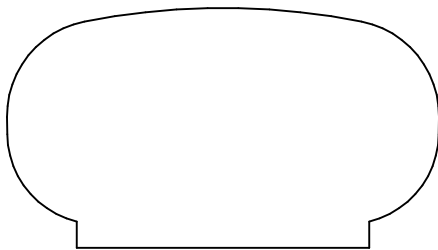

KL 907
1.250 x 2.248

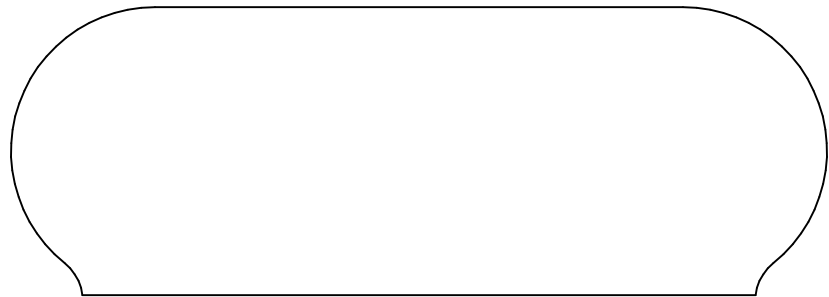

KL 908
1.500 x 4.250

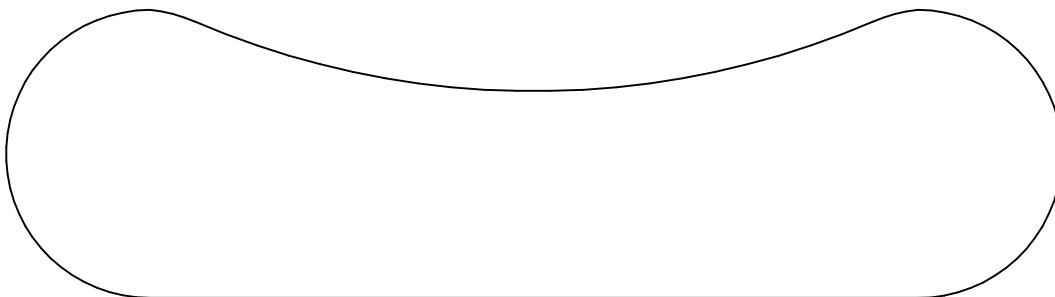

KL 909
1.500 x 5.500

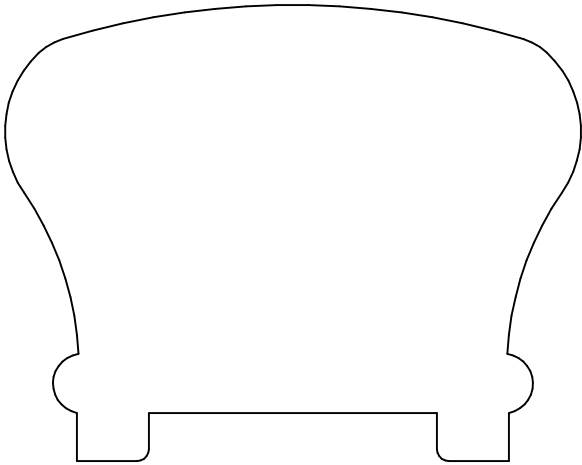

KL 910P
2.375 x 2.994

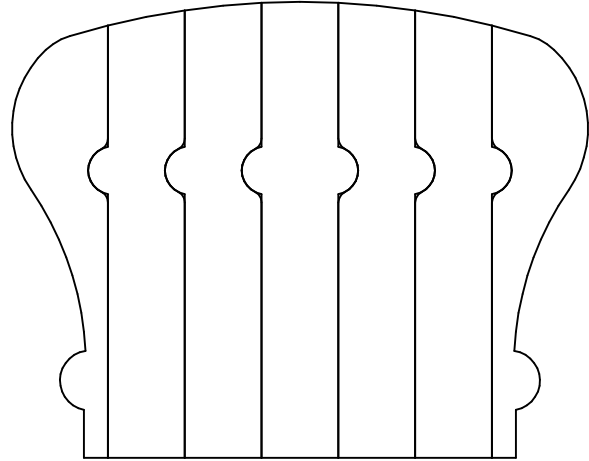

KL 910B
2.375 x 3.000

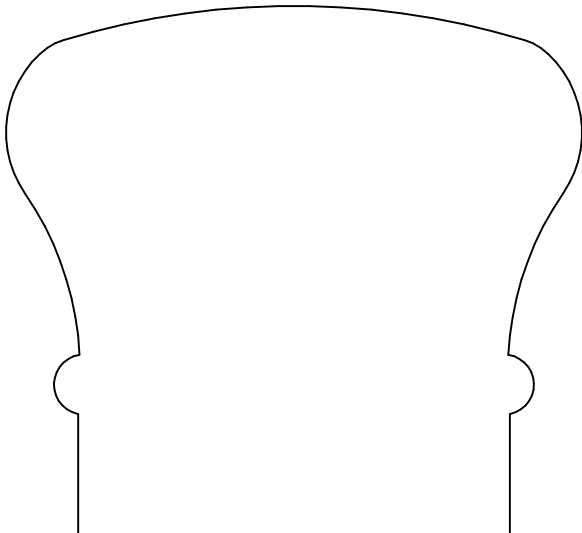

KL 911
2.750 x 3.000

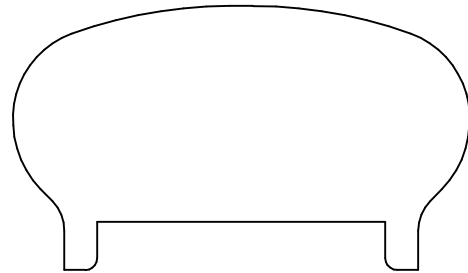

KL 913P
1.375 x 2.378

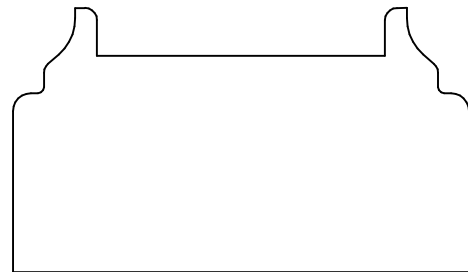

KL 914P
1.375 x 2.375

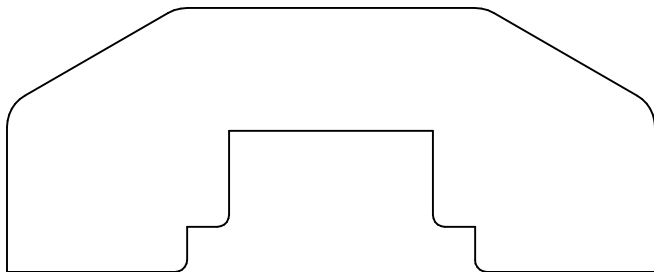

KL 915P
1.375 x 3.375

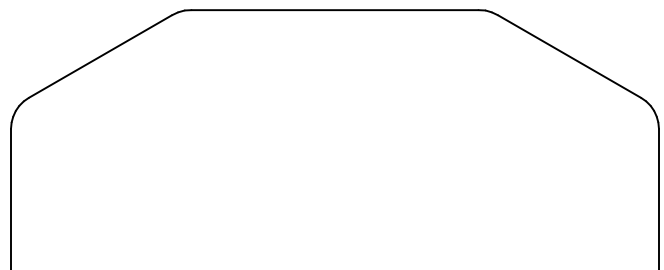

KL 916
1.375 x 3.375

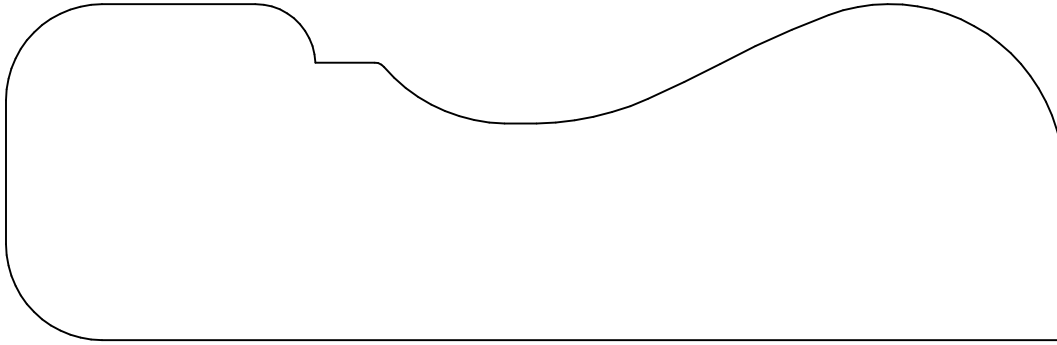

KL 917
1.750 x 5.500

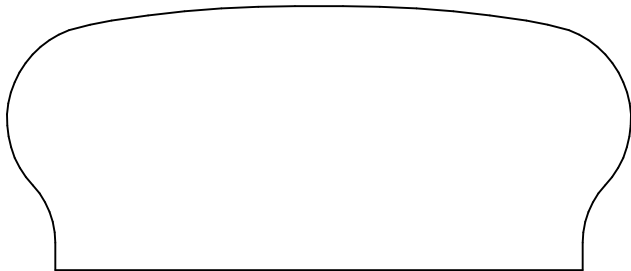

KL 918
1.375 x 3.250

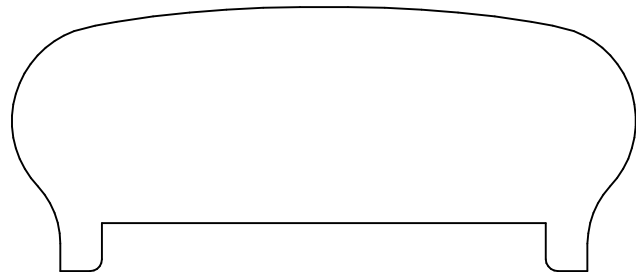

KL 918P
1.375 x 3.250

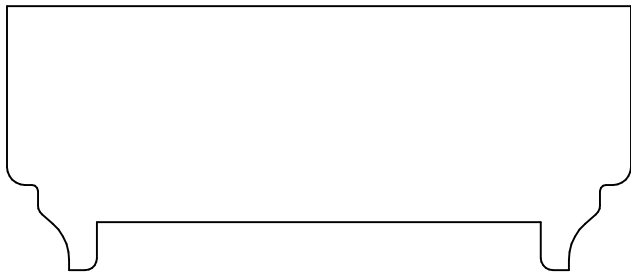

KL 919P
1.375 x 3.250

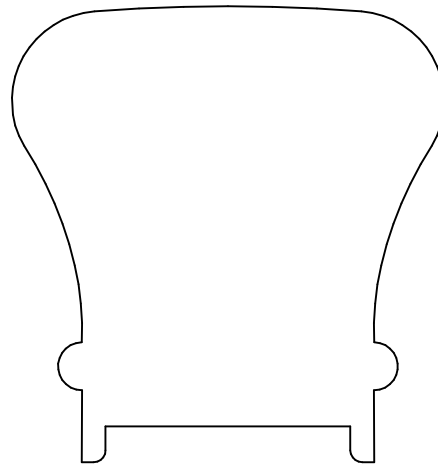

KL 920P_KLS 6010P
2.375 x 2.250

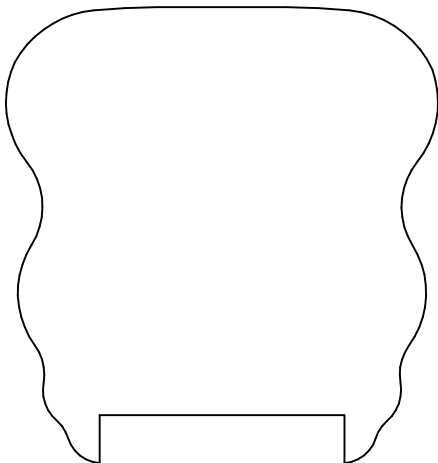

KL 921P_6112P
2.375 x 2.250

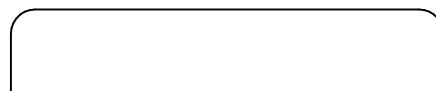

KL 926
.437 x 2.250

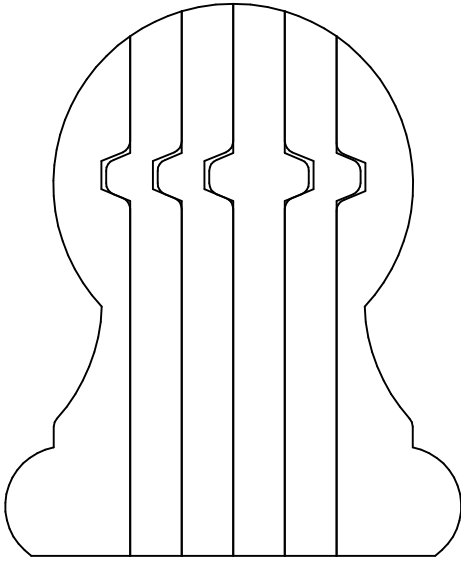

KL 922 B
2.875 x 2.375

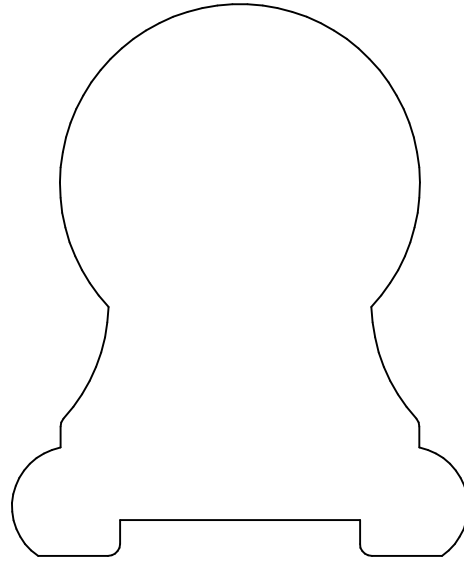

KL 922PO_6109P
2.875 x 2.375

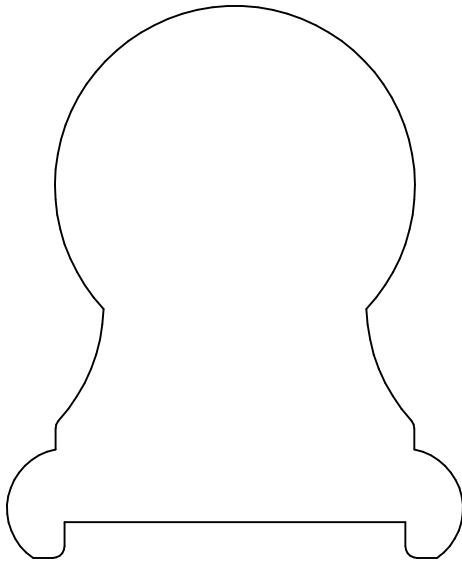

KL 922P1_6109P
2.875 x 2.375

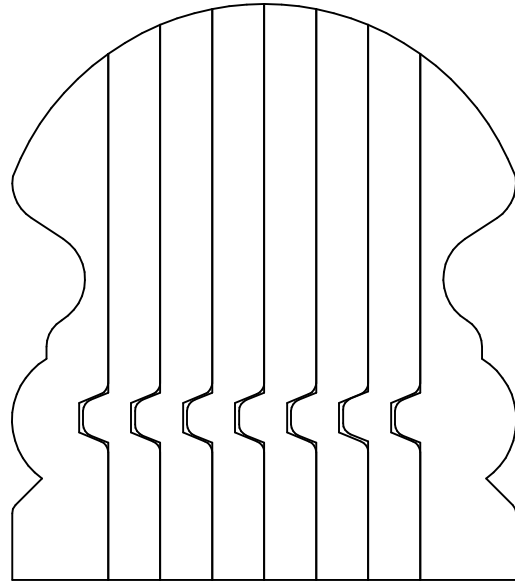

KL 924B_KLS 6519B
3.000 x 2.625

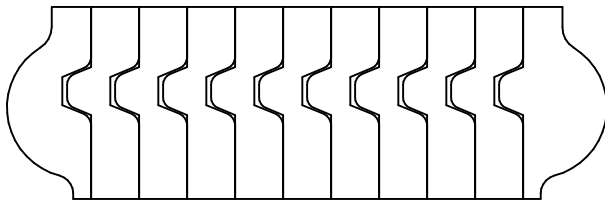

KL 927B
1.000 x 3.125

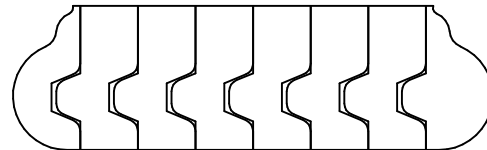

KL 929B
.750 x 2.500

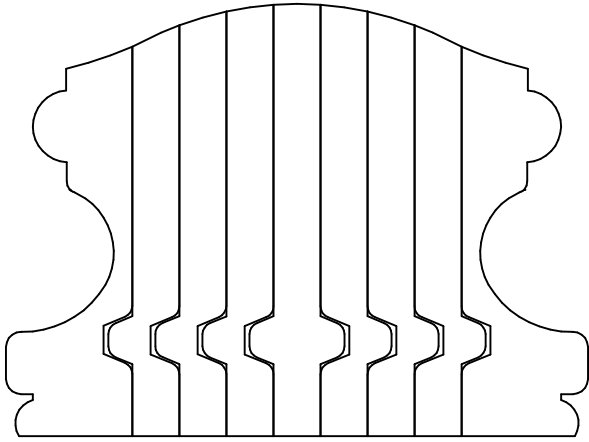

KL 925B_6400B
2.250 x 3.031

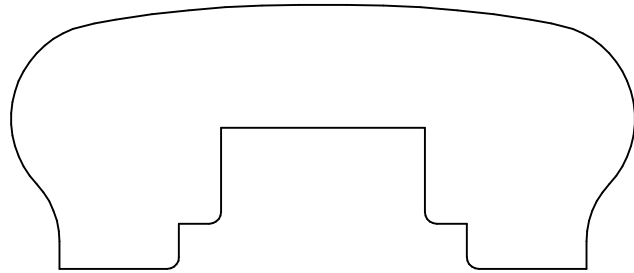

KL 931P
1.375 x 3.250

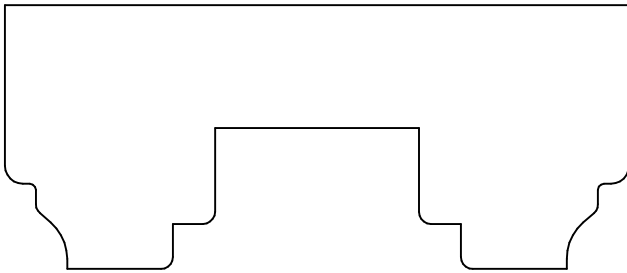

KL 932P
1.375 x 3.250

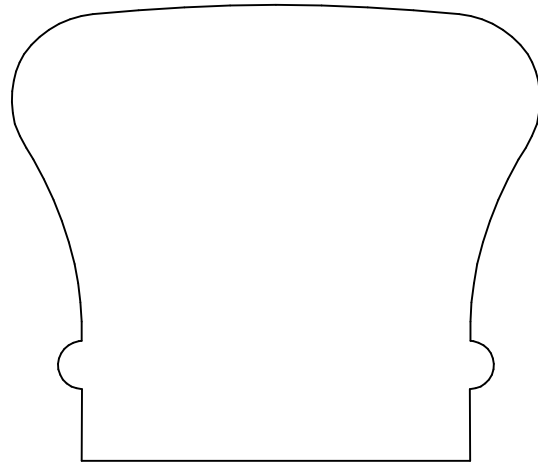

KL 933
2.375 x 2.750

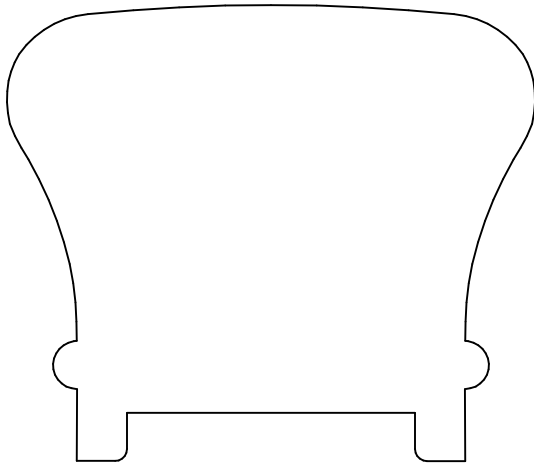

KL 933P
2.375 x 2.750

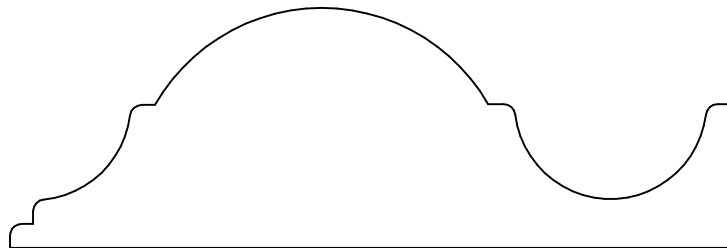

KL 935
1.250 x 3.750

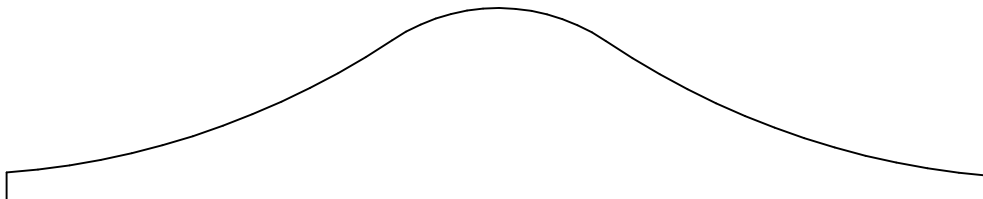

KL 934A
1.000 x 5.125

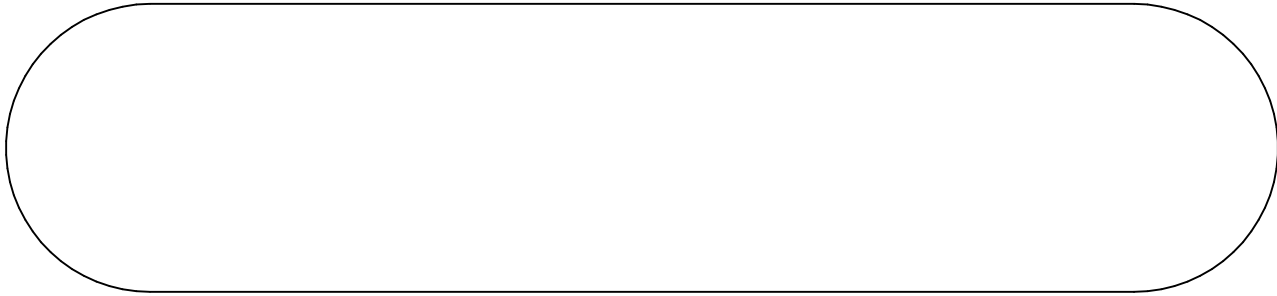

KL 934B
1.500 x 6.625

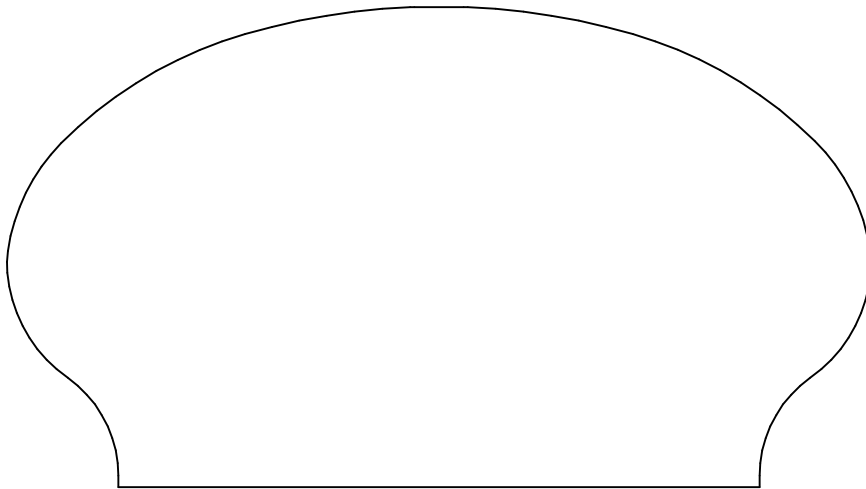

KL 936
2.500 x 4.500

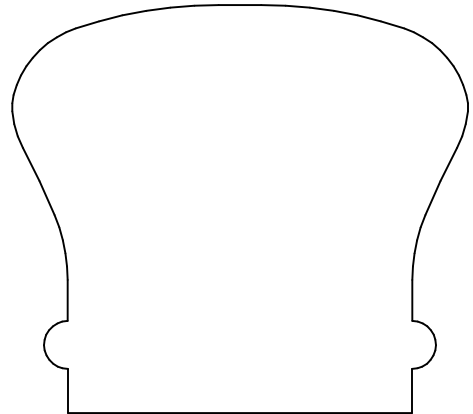

KL 946
2.125 x 2.375

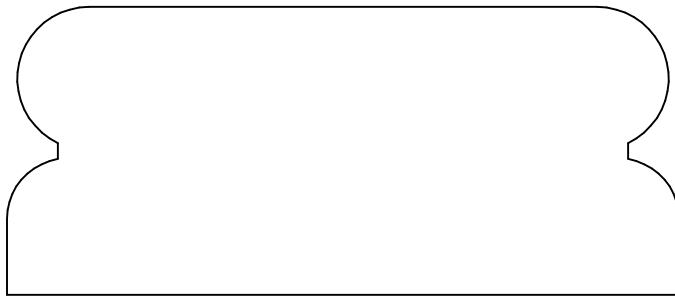

KL 937
1.500 x 3.500

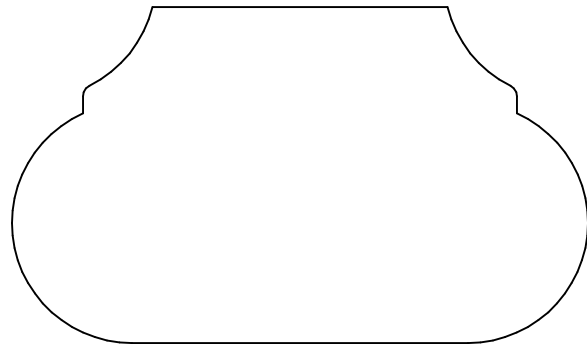

KL 938
1.750 x 3.000

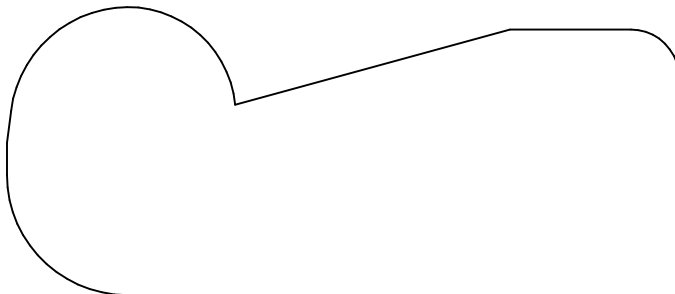

KL 947
1.500 x 3.500

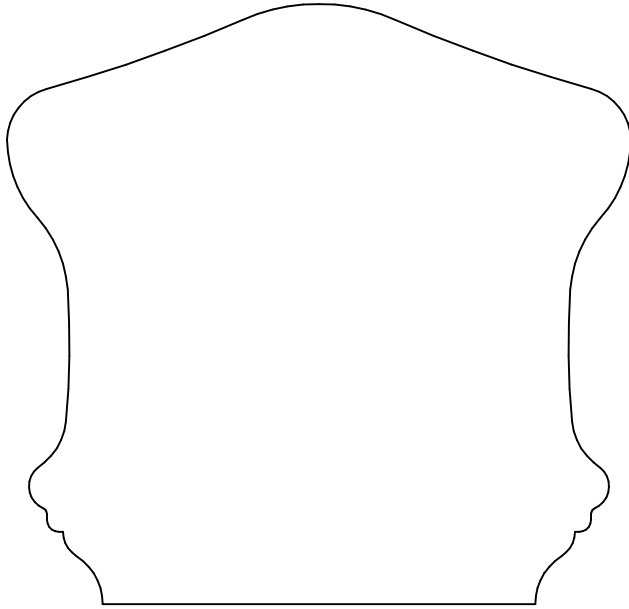

KL 939
3.125 x 3.250

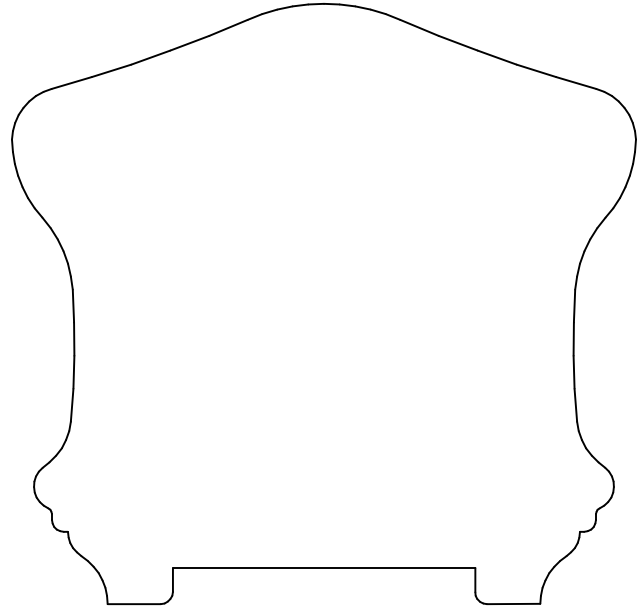

KL 939P
3.125 x 3.250

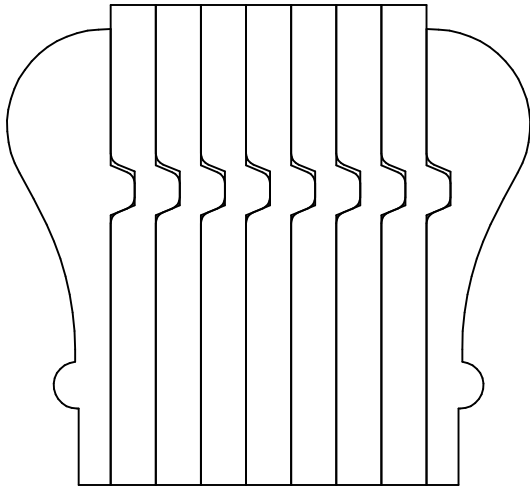

KL 940B
2.500 x 2.725

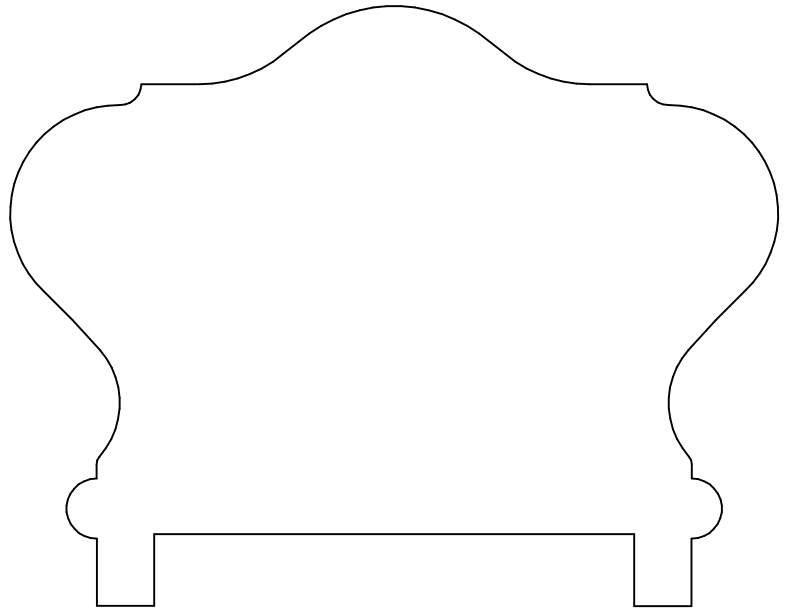

KL 941P
3.125 x 4.000

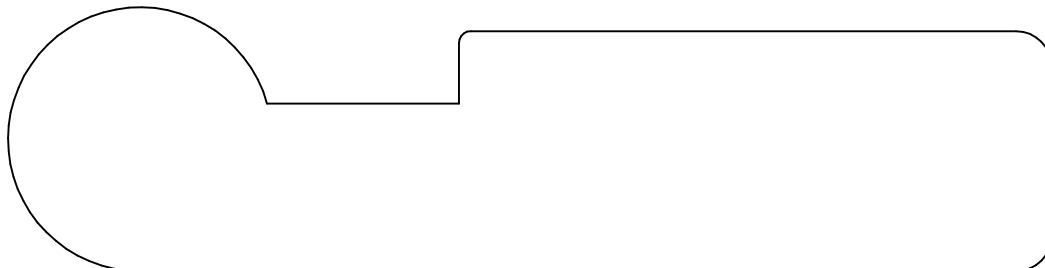

KL 944
1.375 x 5.437

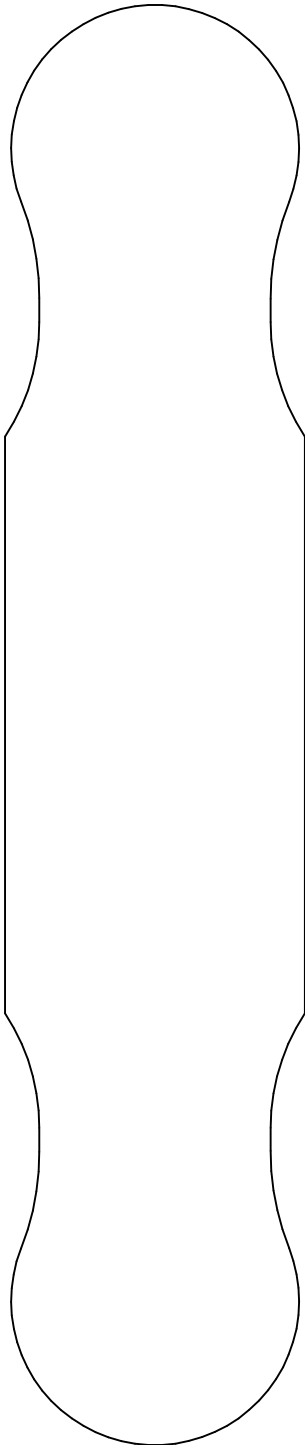

KL 942
1.562 x 7.500



KL 943
1.000 x 7.500

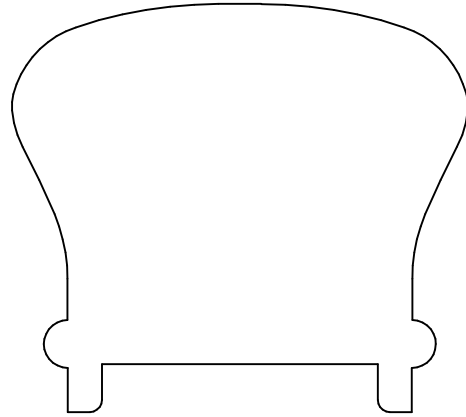

KL 946P
2.125 x 2.375

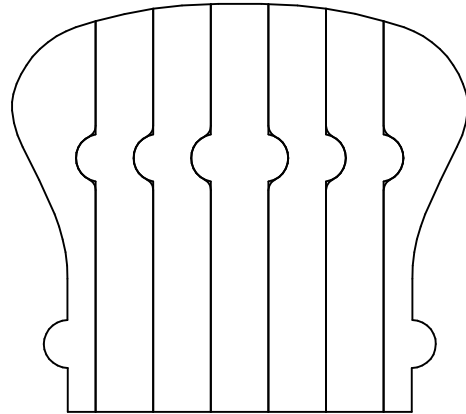

KL 946B
2.125 x 2.375

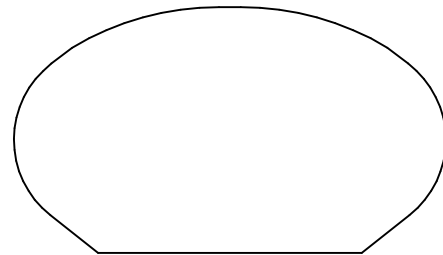

KL 949_6042
1.281 x 2.250

CUSTOM PROFILES

Handrail

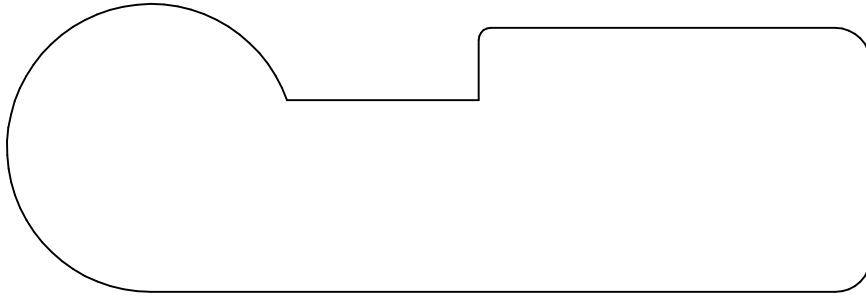

KL 945
1.500 x 4.500

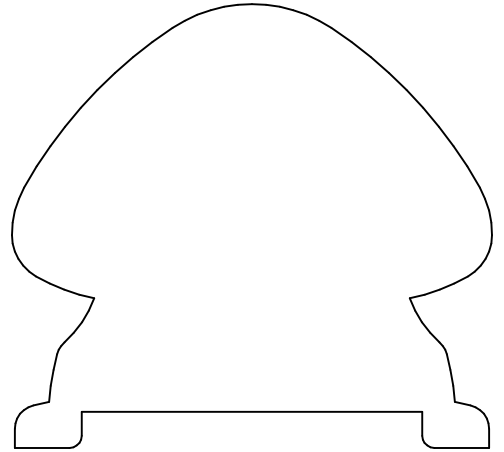

KL 951P_6005P
2.312 x 2.500

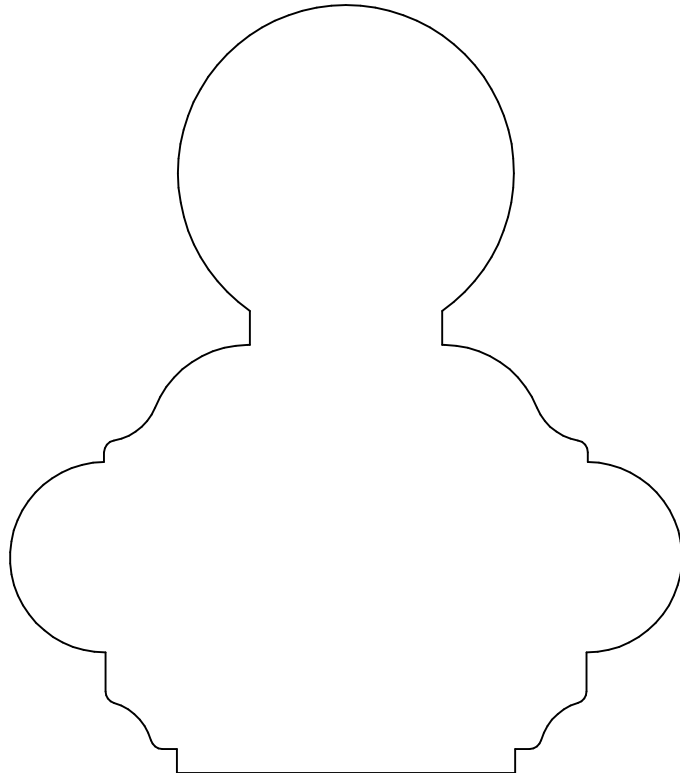

KL 950
4.000 x 3.500

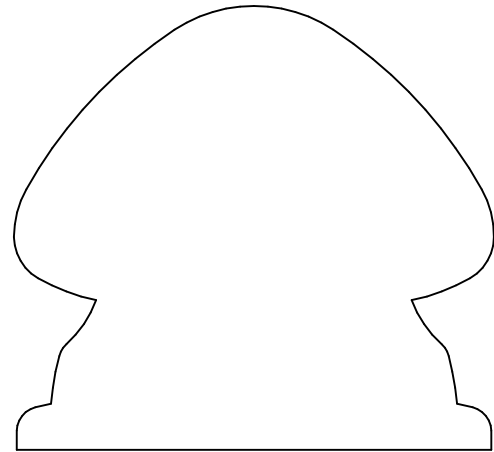

KL 951_6005
2.312 x 2.500

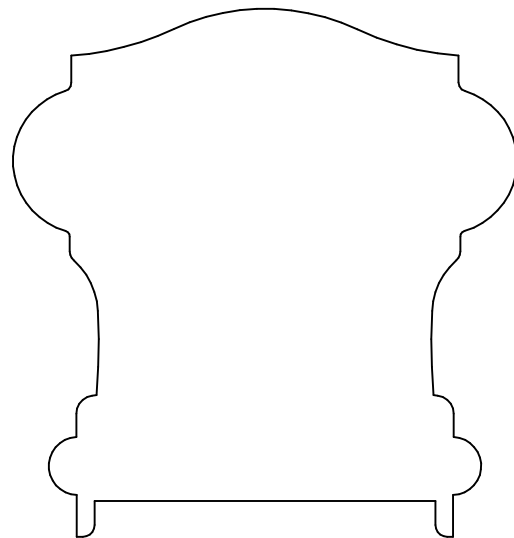

KL 955P_6900P
2.750 x 2.625

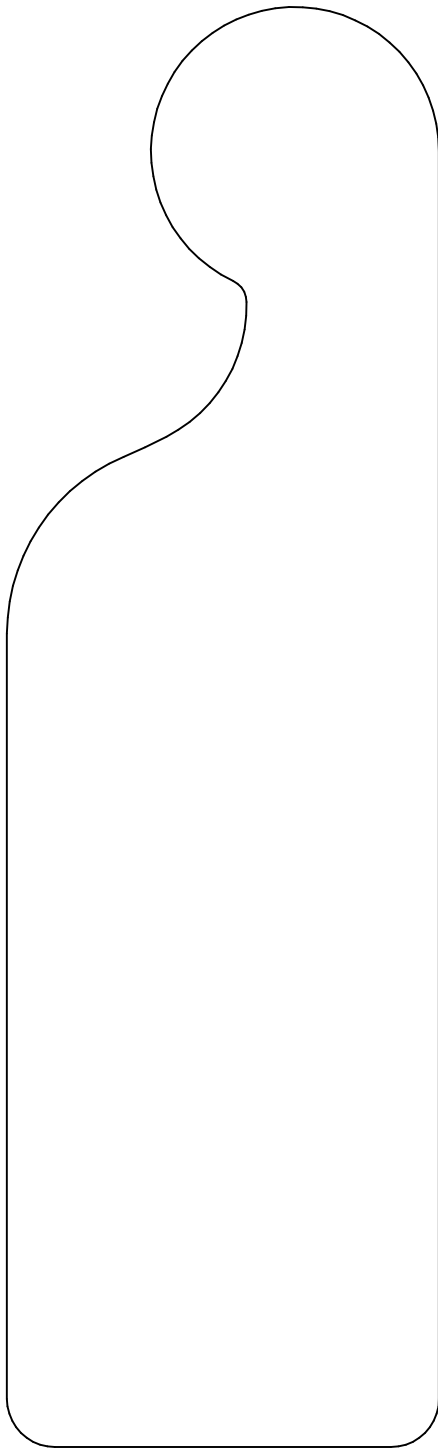

KL 948
2.250 x 7.500

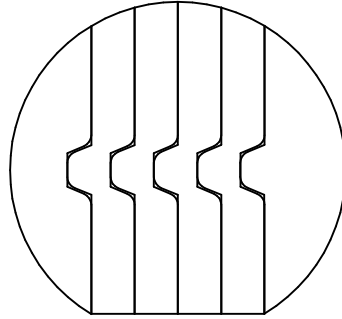

KL 952B
1.625 x 1.749



KL 971_6000F
.375 x 1.250

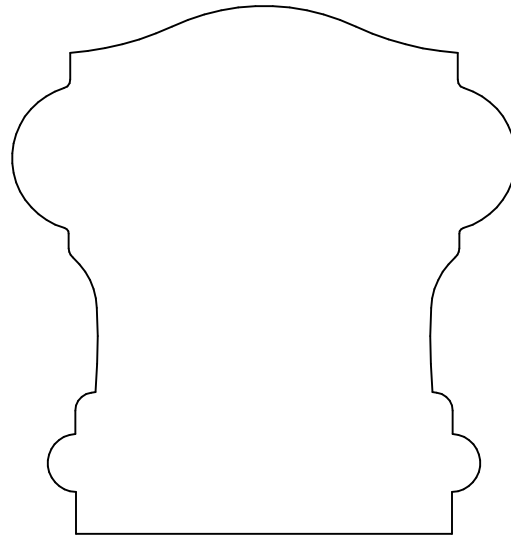

KL 955_6900
2.749 x 2.625



KL 966P_6001P
.750 x 2.500

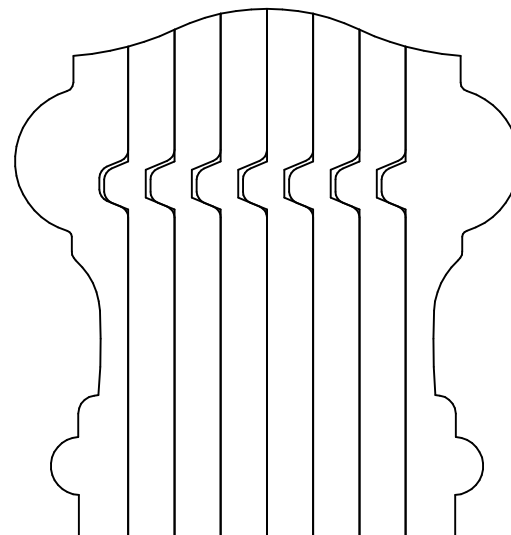

KL 955B
2.750 x 2.625

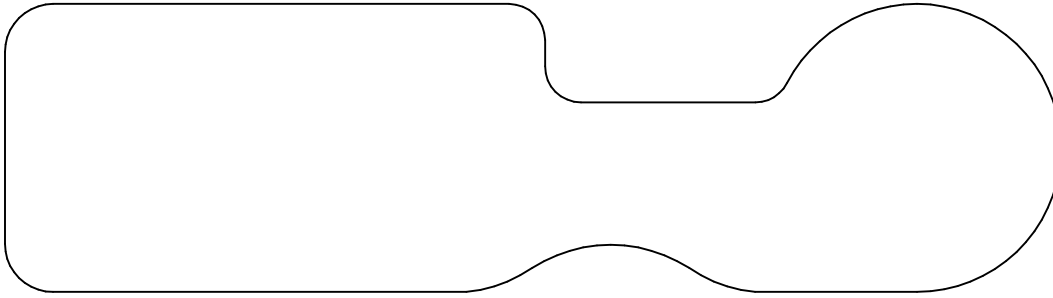

KL 953
1.500 x 5.500

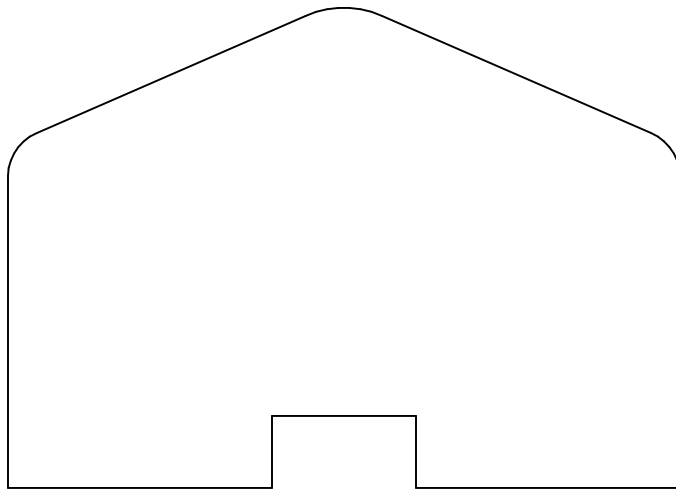

KL 954P
2.500 x 3.500



KL 977
.500 x 1.000

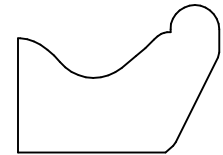

KL 976
.768 x 1.049

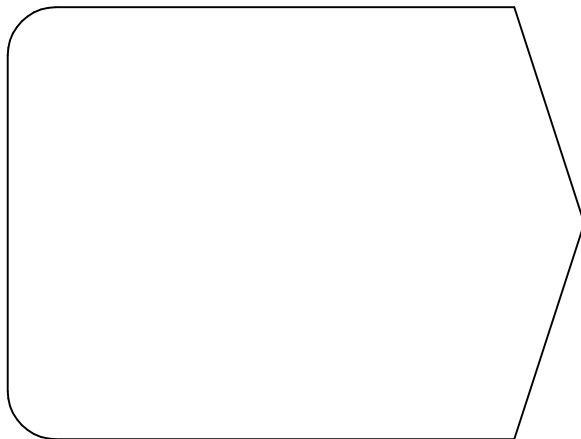

KL 957
2.250 x 3.000

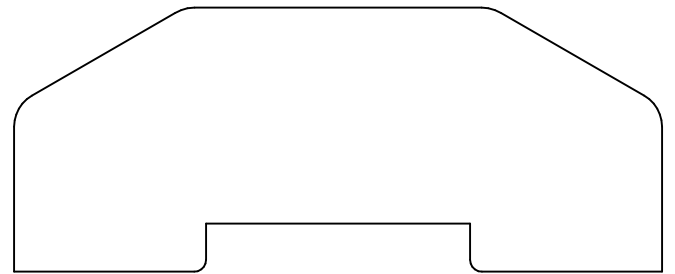

KL 958P
1.375 x 3.375

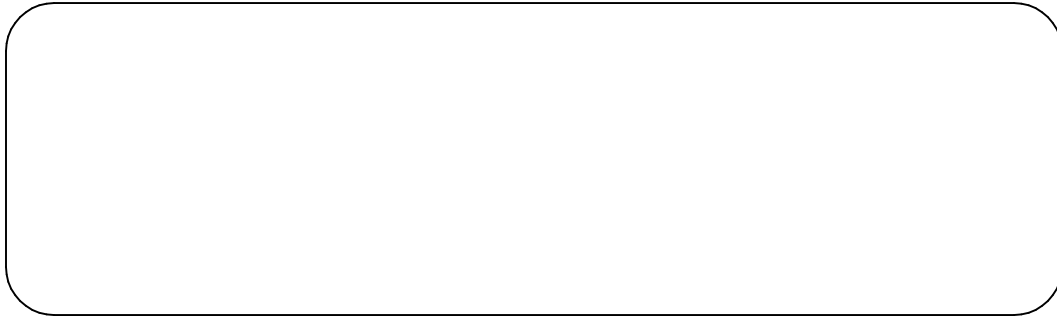

KL 960_6003
1.625 x 5.500

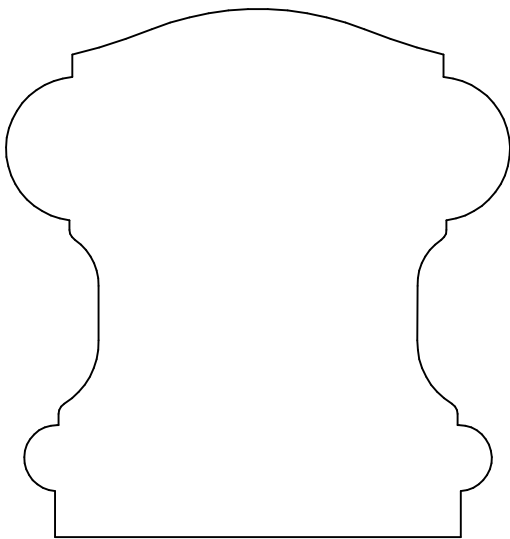

KL 961_6710
2.750 x 2.625

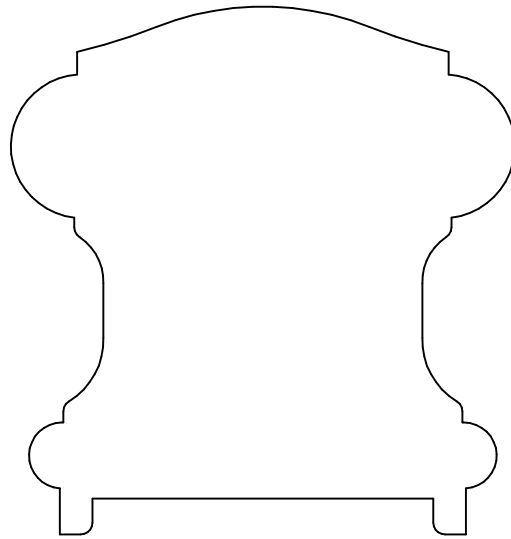

KL 961P_6710P
2.750 x 2.625

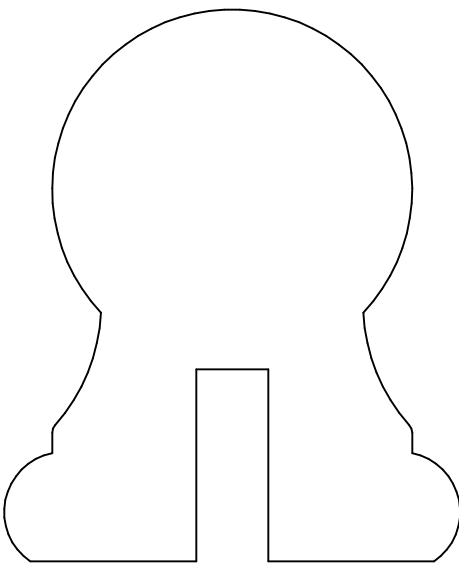

KL 956_6109G
2.875 x 2.375

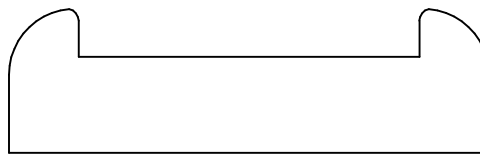

KL 966P_6001P
.750 x 2.500

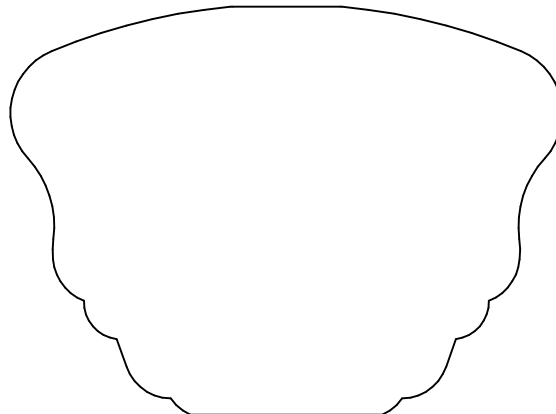

KL 964
2.125 x 2.875

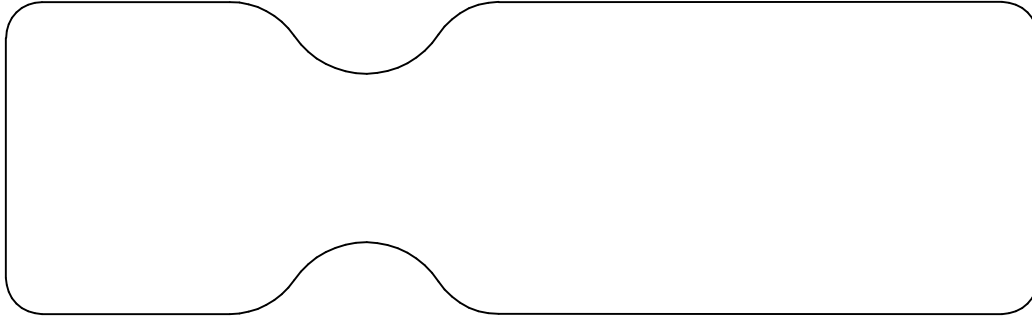

KL 962_6203
1.625 x 5.375

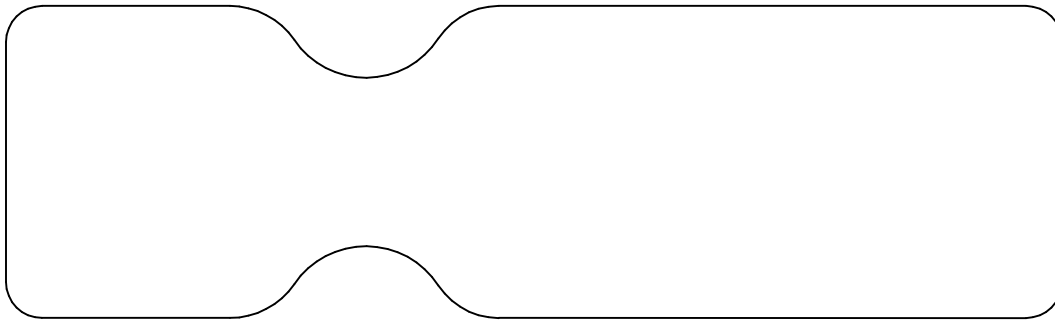

KL 963_6203
1.625 x 5.500

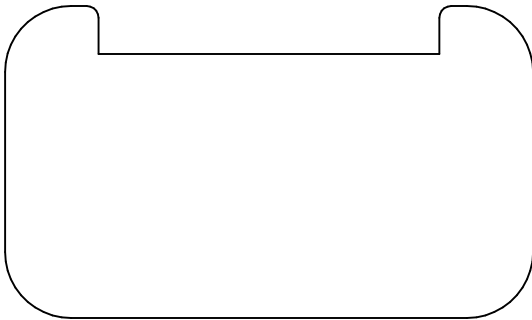

KL 965P_6001P
1.625 x 2.750

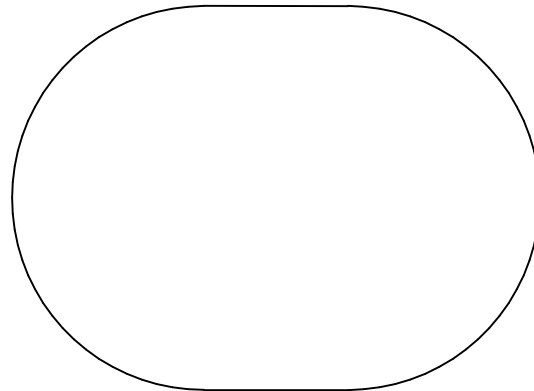

KL 967
2.000 x 2.750

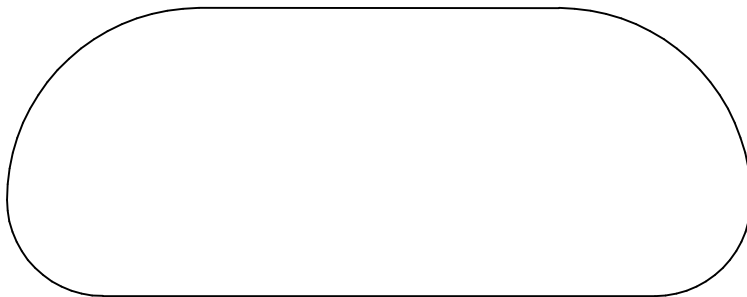

KL 969
1.500 x 3.875

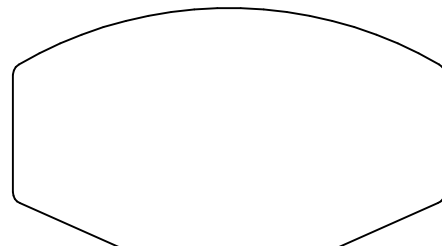

KL 970
1.250 x 2.250

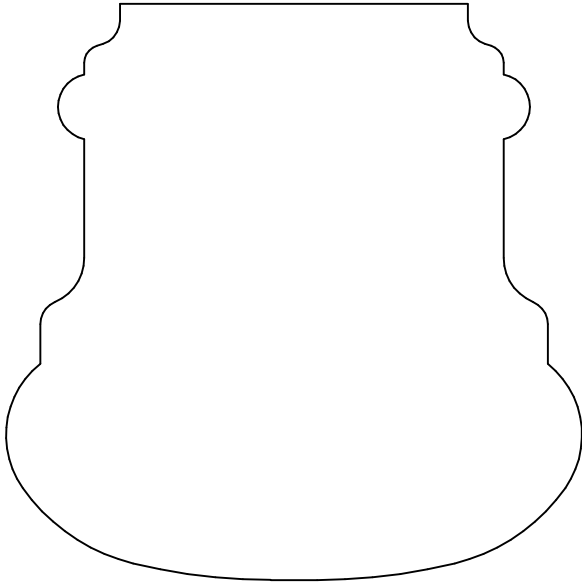

KL 972
3.000 x 3.000

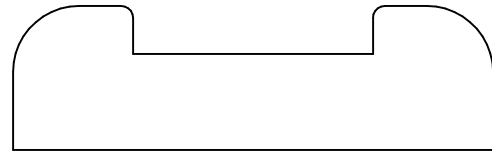

KL 973P_6000S
.750 x 2.500

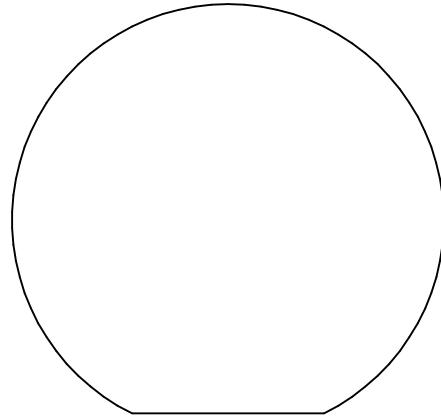

KL 974
2.133 x 2.250

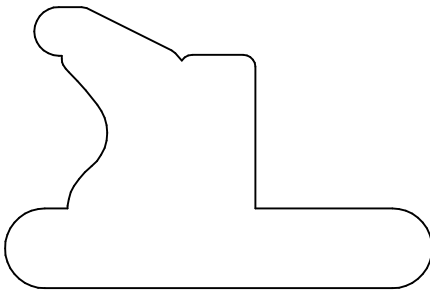

KL 975
1.465 x 2.225

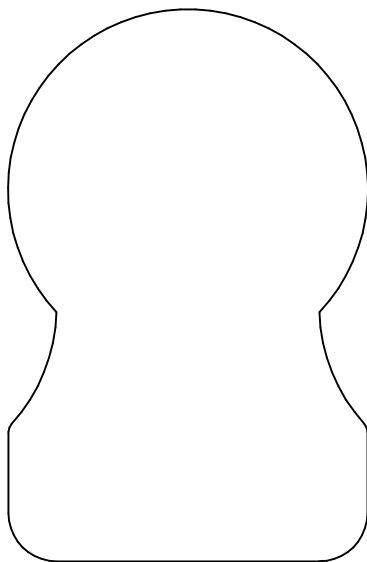

KL 979
2.875 x 1.875

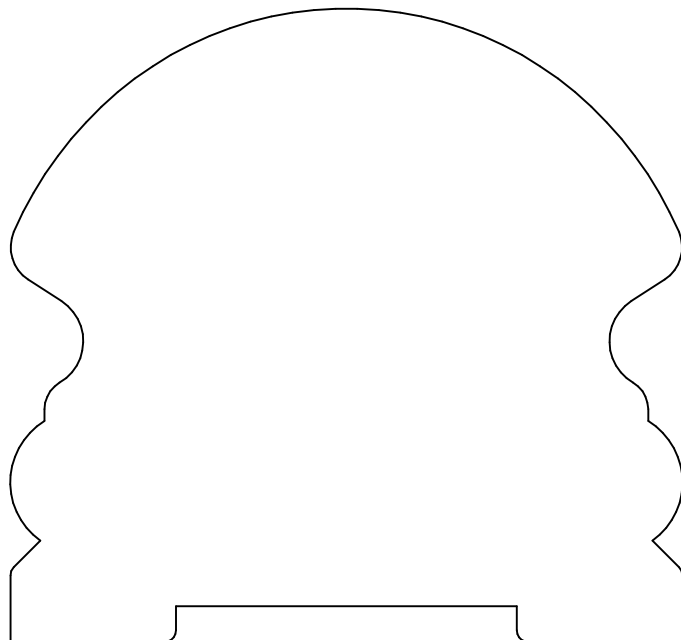

KL 978P
3.300 x 3.502

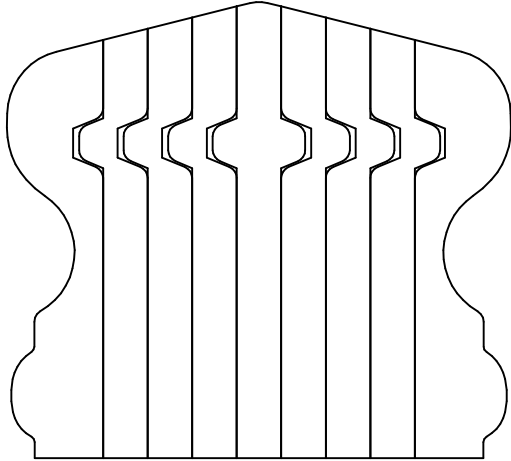

KL 968B_KLS 6910B
2.375 x 2.625

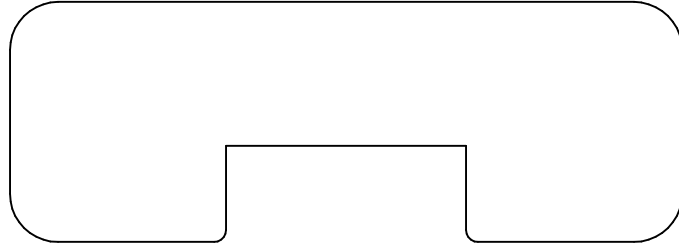

KL 980P
1.250 x 3.500

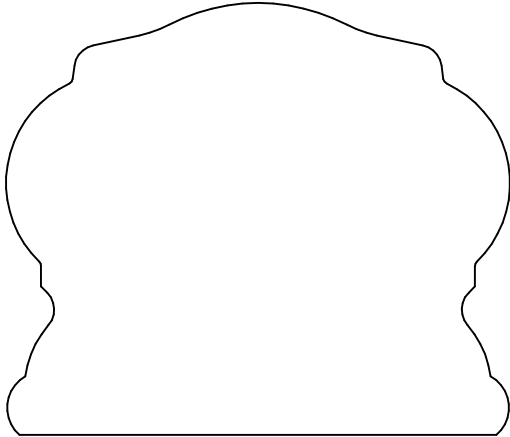

KL 981_6810
2.250 x 2.625

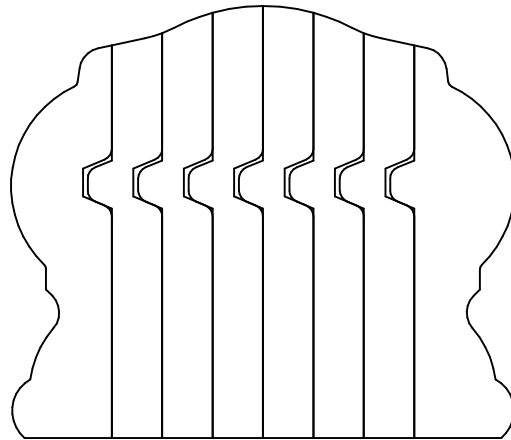

KL 981B_6810B
2.250 x 2.625

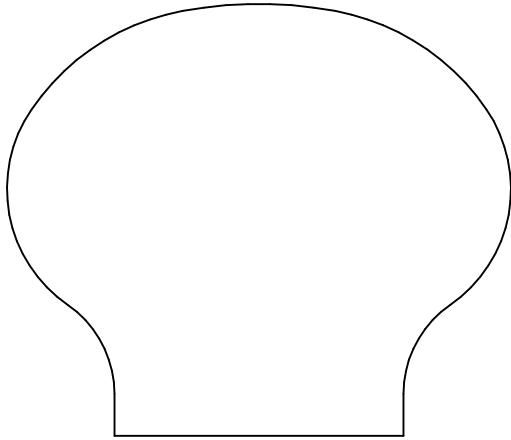

KL 982_6600
2.250 x 2.625

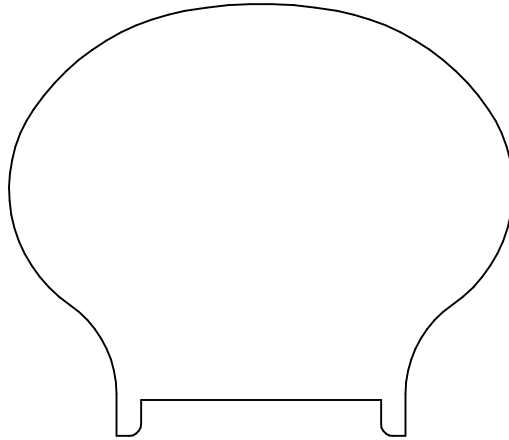

KL 982P_6600P
2.250 x 2.625

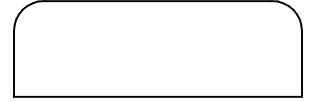

KL 993
.500 x 1.500

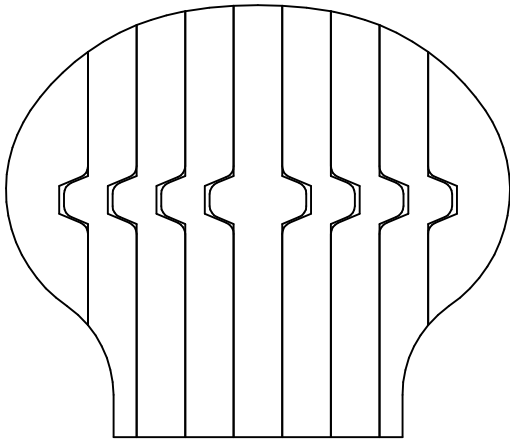

KL 982B_6600B
2.250 x 2.625

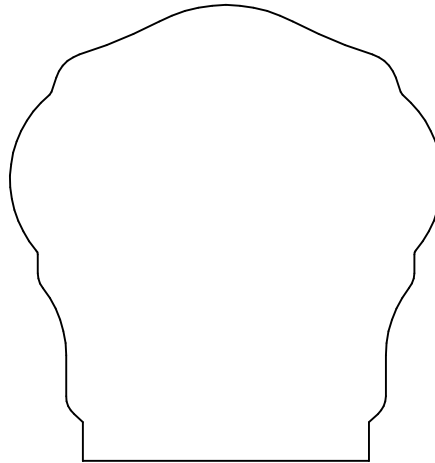

KL 983
2.375 x 2.250

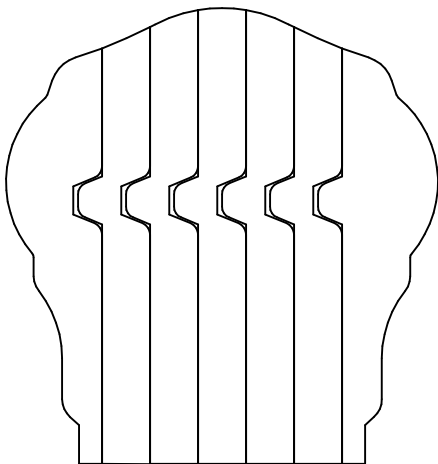

KL 983B
2.375 x 2.250

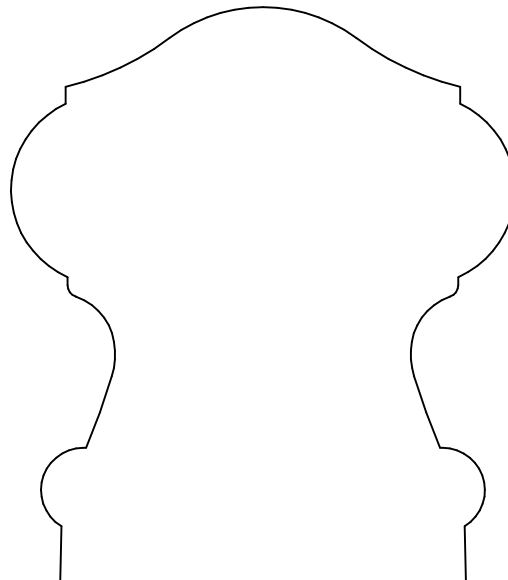

KL 984
3.000 x 2.625

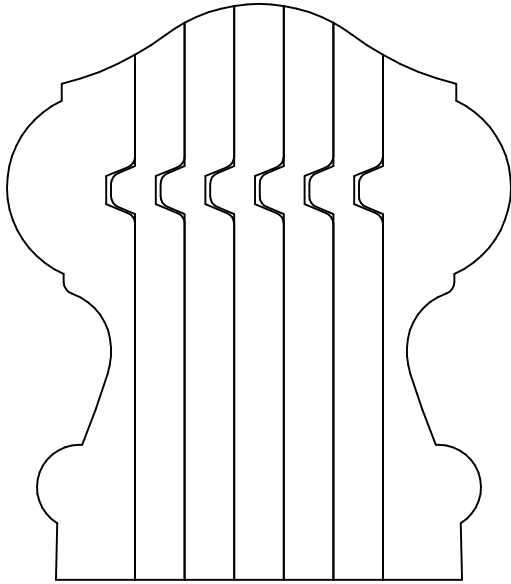

KL 984B
3.000 x 2.625

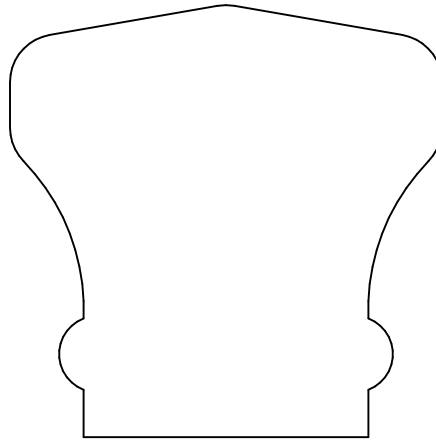

KL 985_6601
2.250 x 2.250

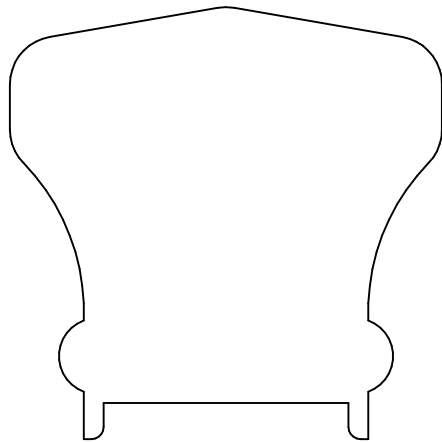

KL 985P_6601P
2.250 x 2.250

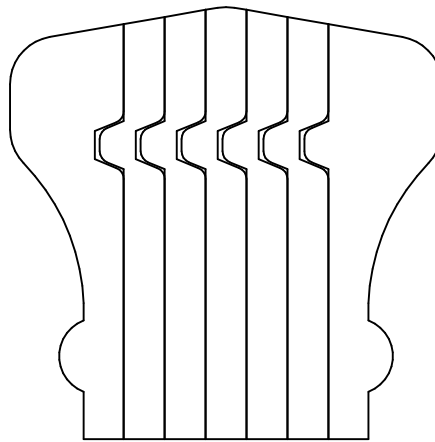

KL 985B_6601B
2.250 x 2.250

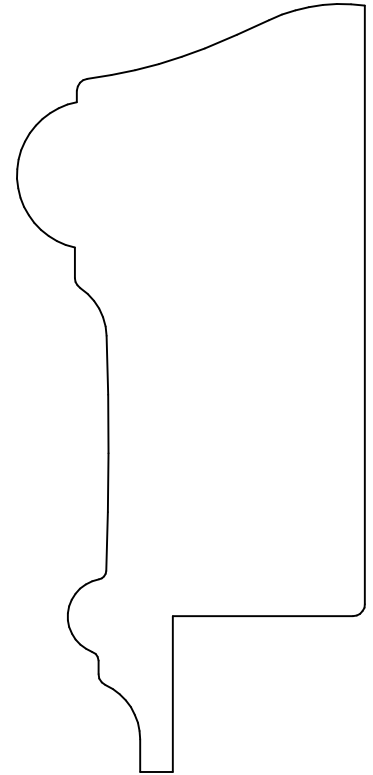

KL 996
4.000 x 1.812

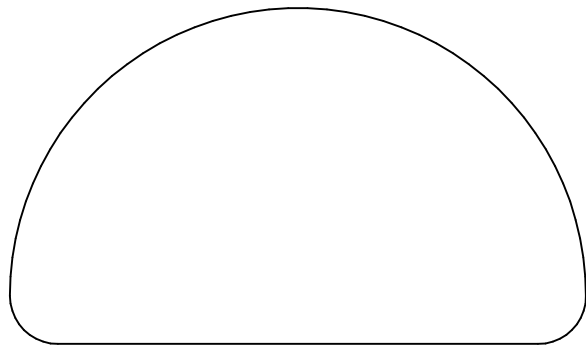

KL 986
1.750 x 3.000

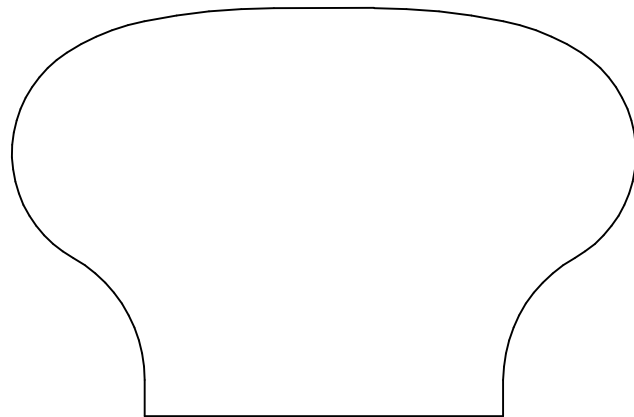

KL 987
2.125 x 3.250

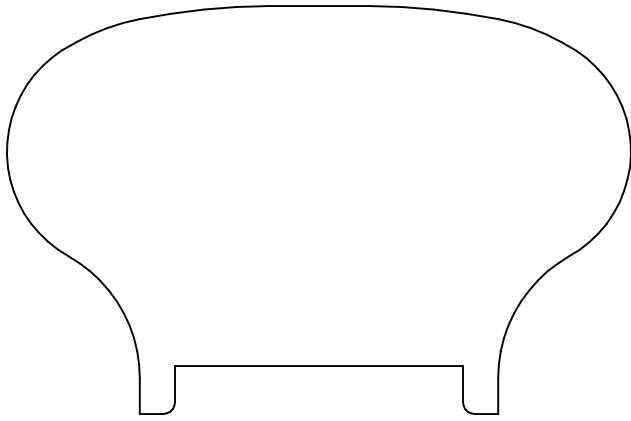

KL 987P
2.125 x 3.250

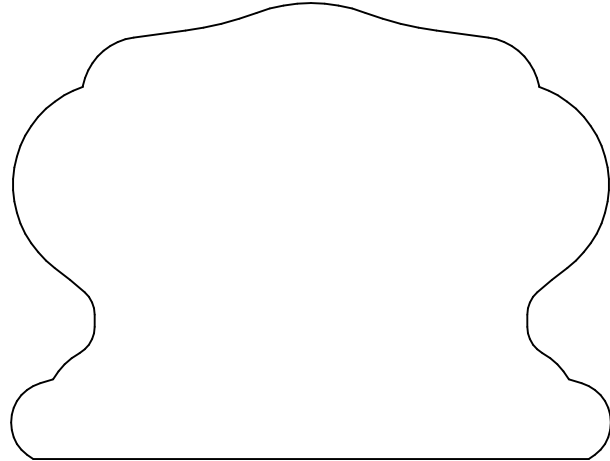

KL 988
2.375 x 3.125

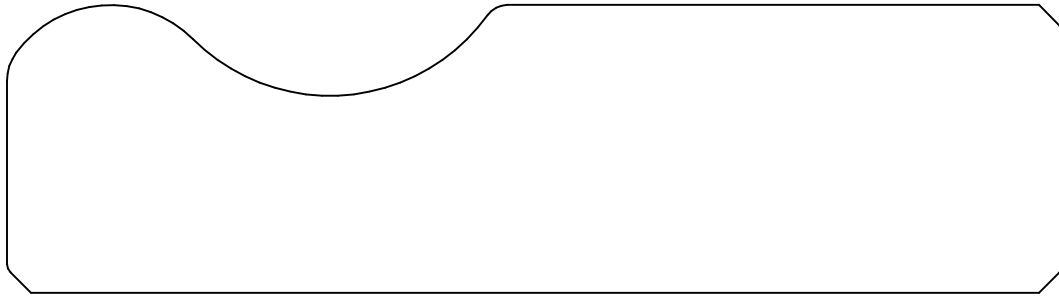

KL 989
1.500 x 5.500

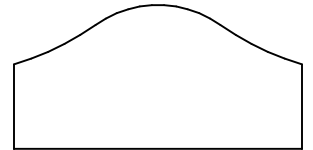

KL 1903
.750 x 1.500

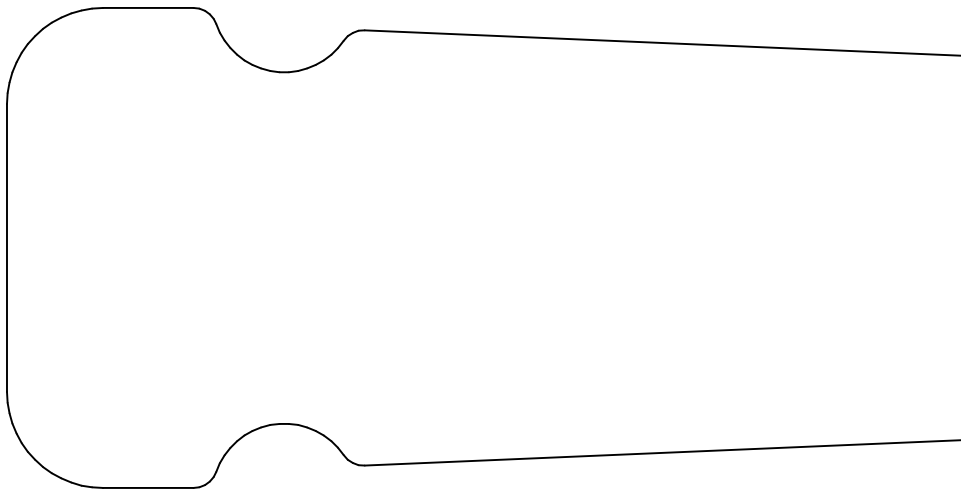

KL 990
5.000 x 2.500

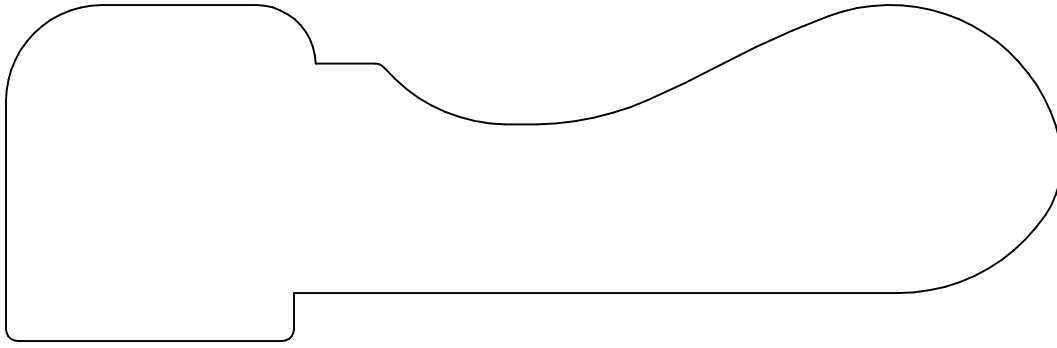

KL 991
1.750 x 5.500

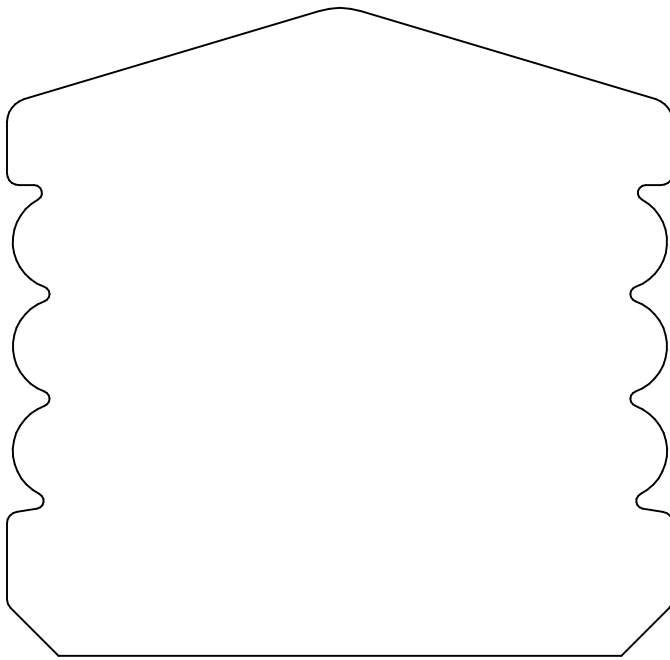

KL 992
3.375 x 3.468

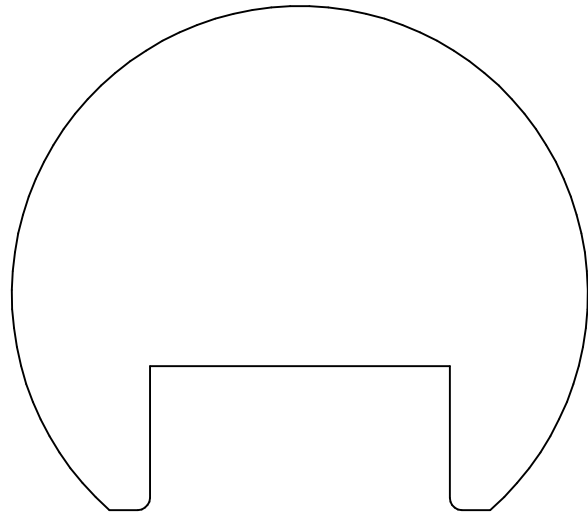

KL 997P
2.625 x 3.000

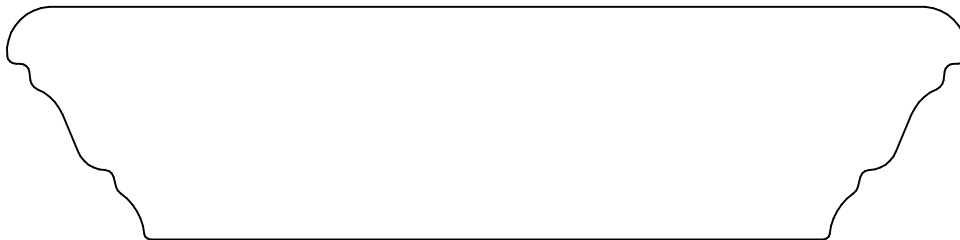

KL 994
1.210 x 5.000

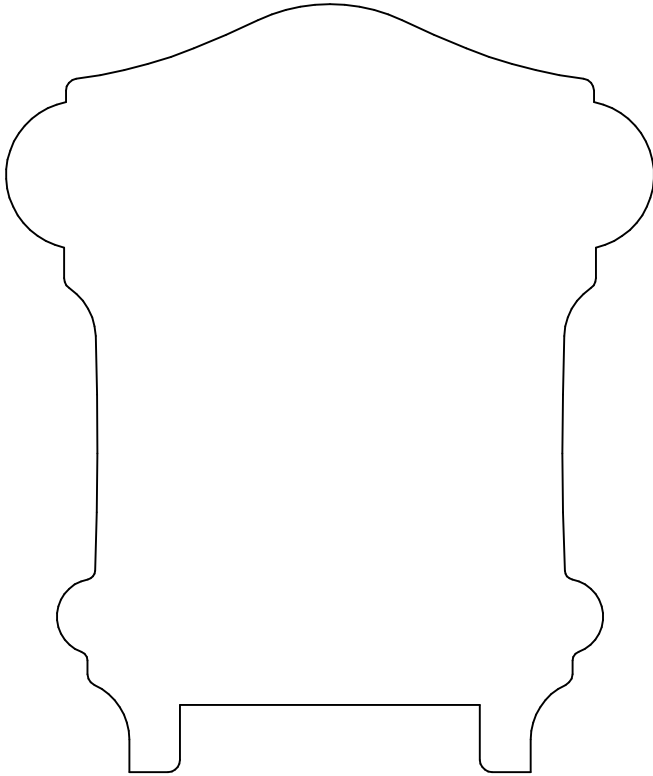

KL 995P
4.000 x 3.375

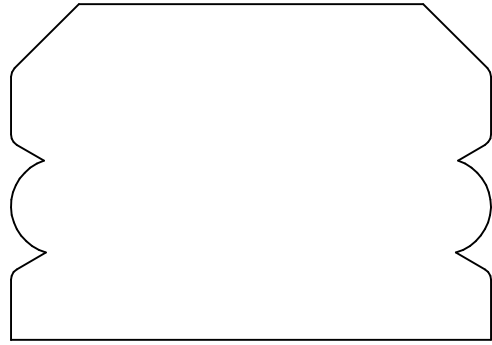

KL 998
1.750 x 2.500

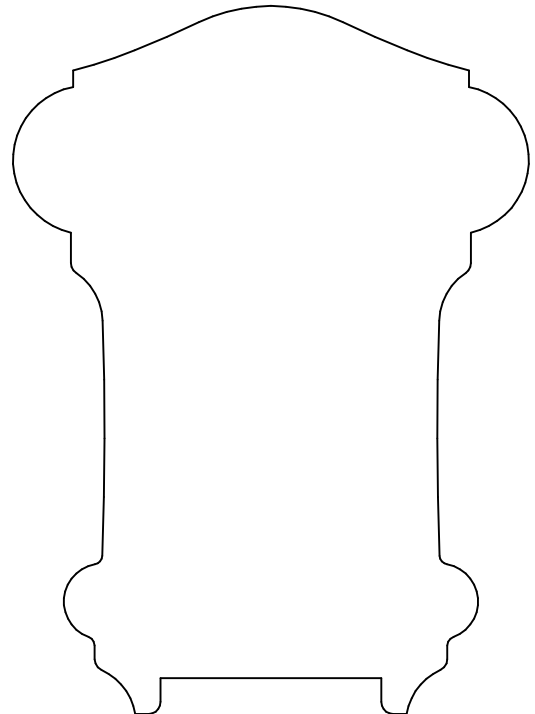

KL 1900P
3.687 x 2.687

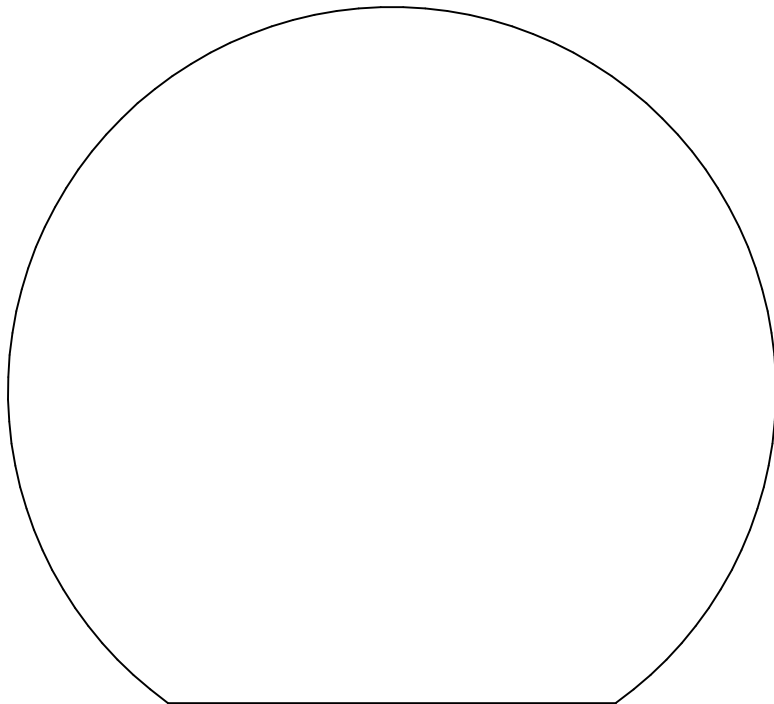

KL 999
3.625 x 4.000

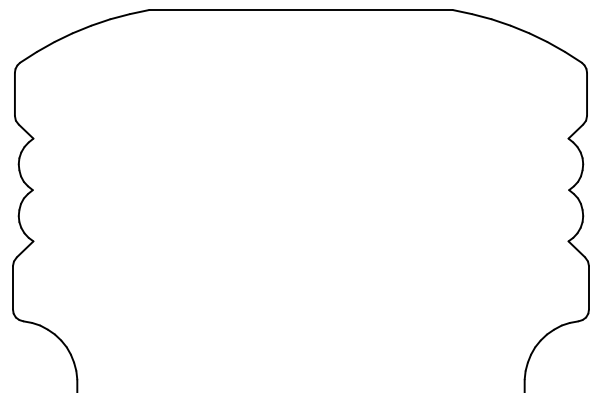

KL 1901
2.000 x 3.000

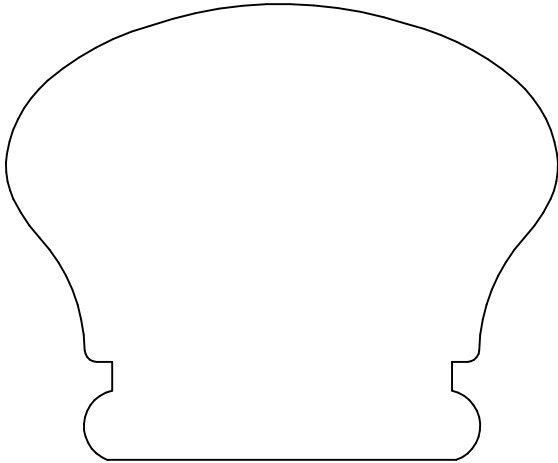

KL 1902
2.375 x 2.875

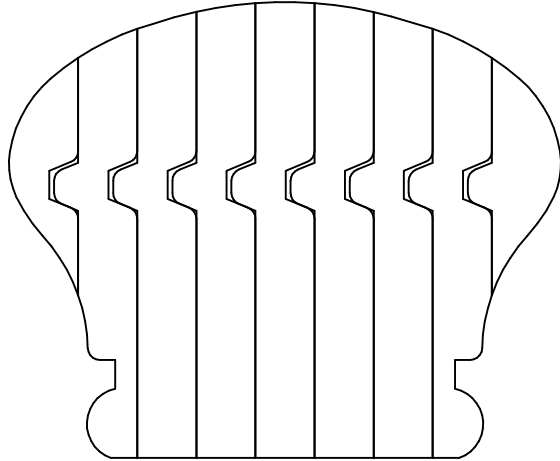

KL 1902B
2.375 x 2.875

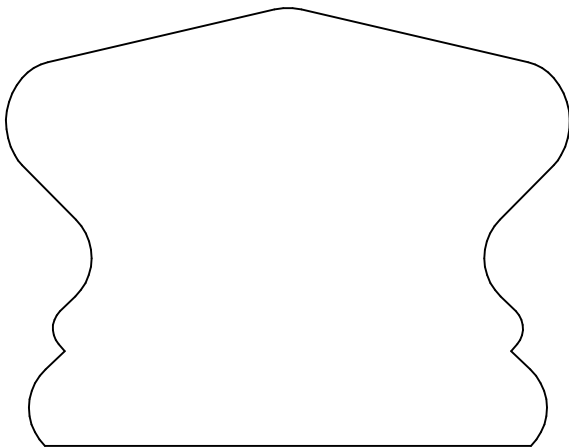

KL 1904
2.281 x 2.937

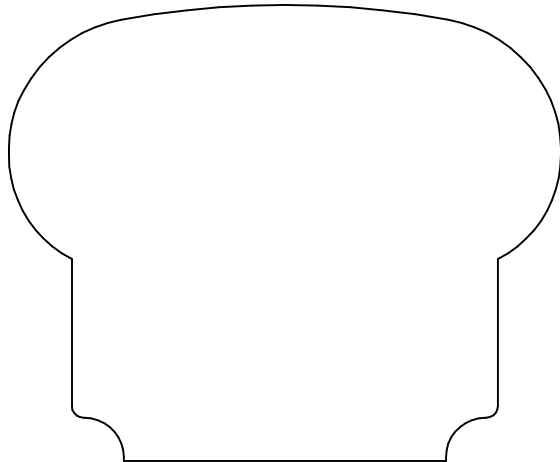

KL 1905
2.375 x 2.875

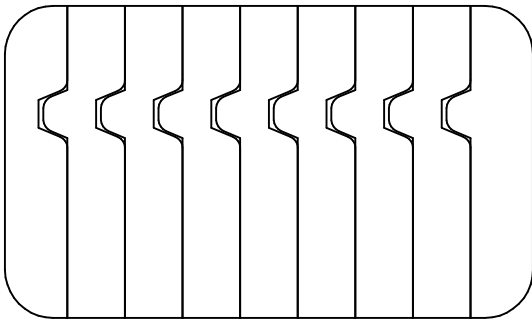

KL 1906B
1.625 x 2.750

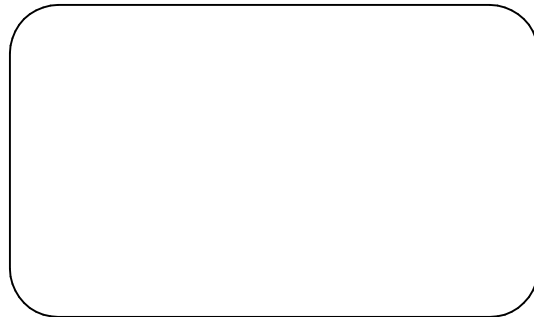

KL 1906_6002
1.625 x 2.750



KL 1913
.687 x 1.437

CUSTOM PROFILES

Handrail

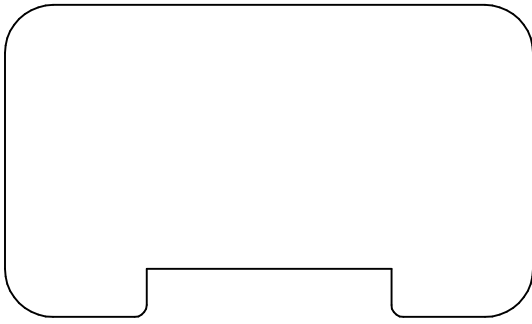

KL 1906P
1.625 x 2.750

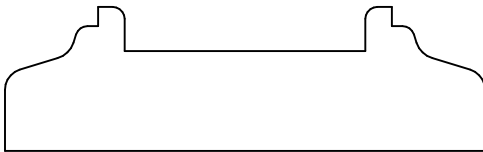

KL 1910P
.750 x 2.500

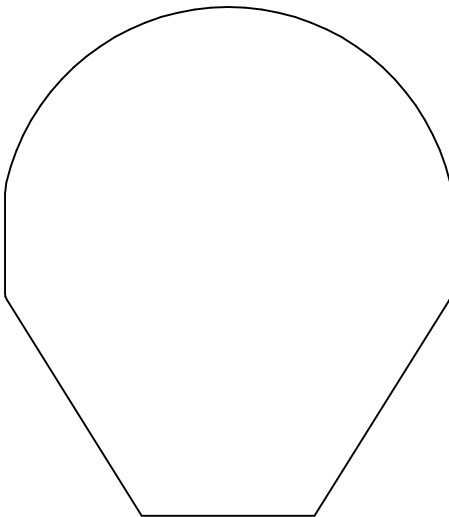

KL 1918
2.650 x 2.325



KL 1908P
.750 x 3.250

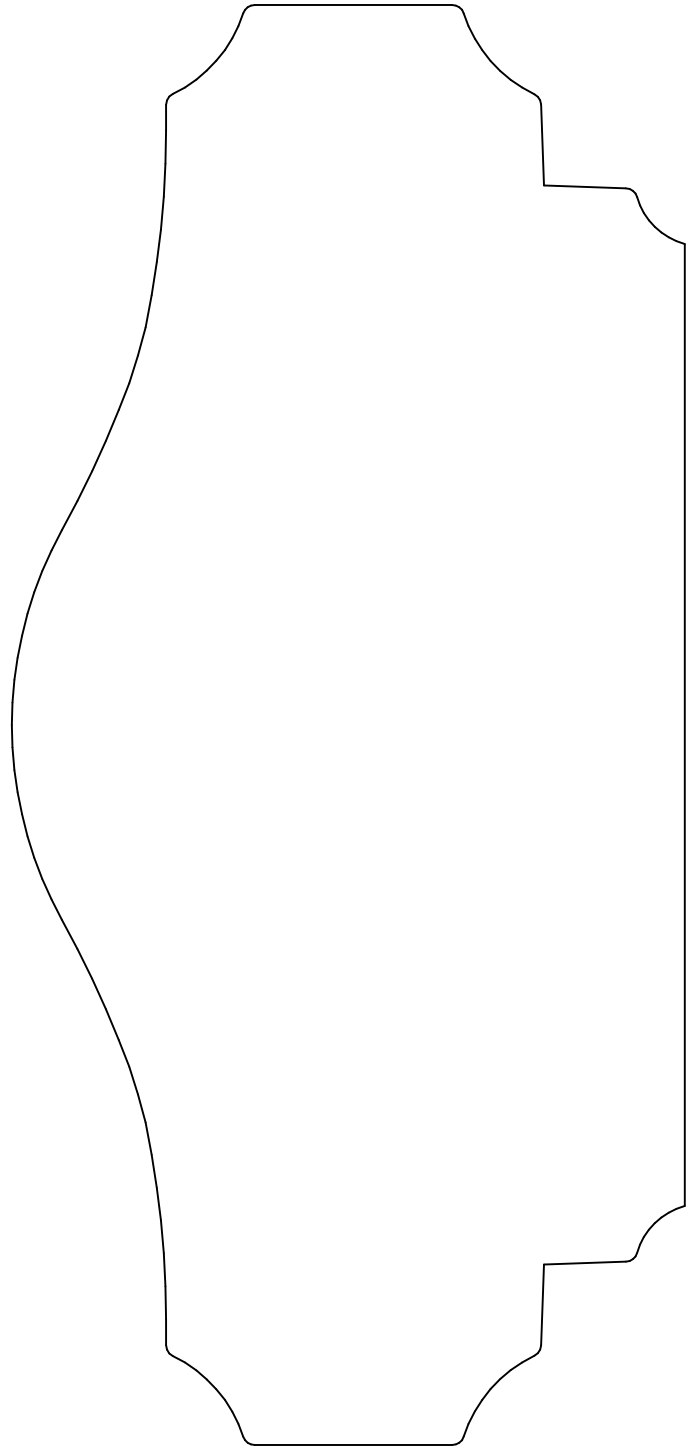

KL 1907
3.504 x 7.500

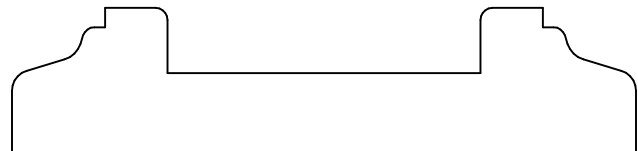

KL 1909P
.750 x 3.250

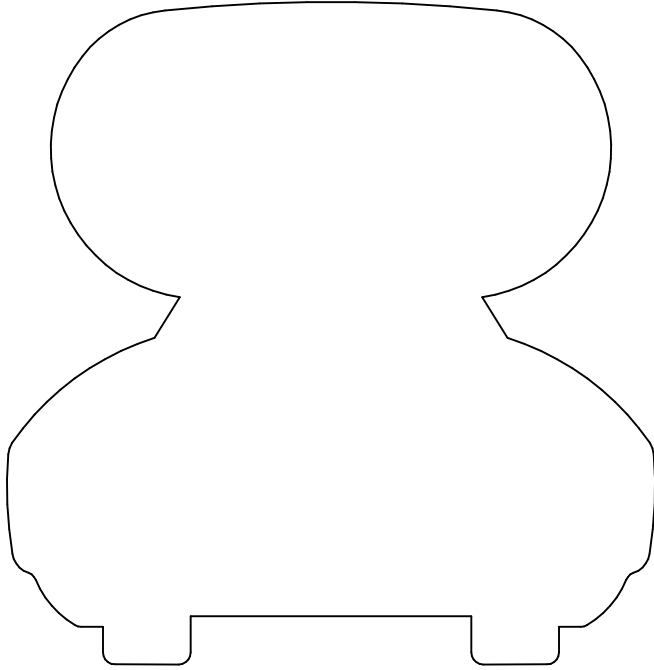

KL 1911P
3.450 x 3.375

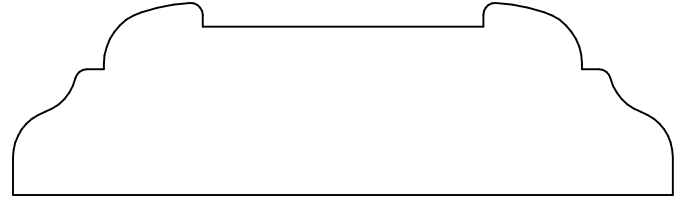

KL 1912P
1.000 x 3.437

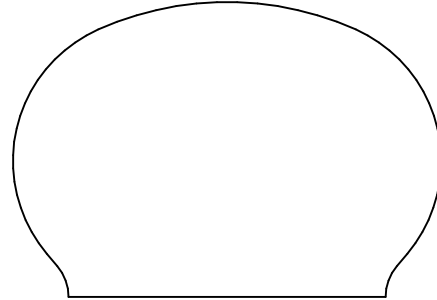

KL 1923A
1.537 x 2.230

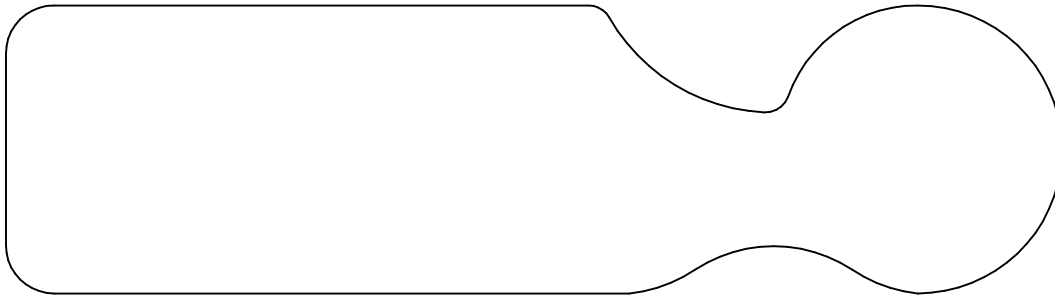

KL 1916
1.500 x 5.500

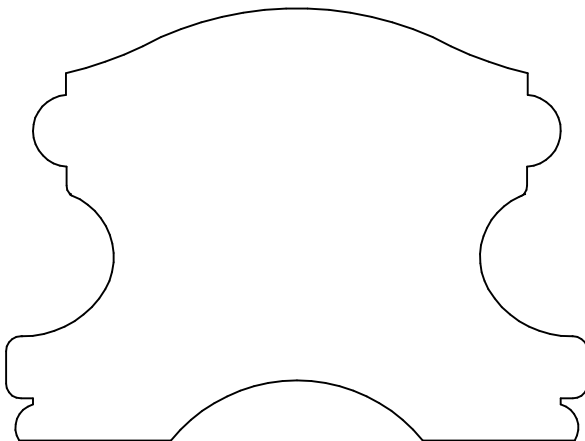

KL 1917
2.250 x 3.030



KL 1923B
1.213 x 2.500

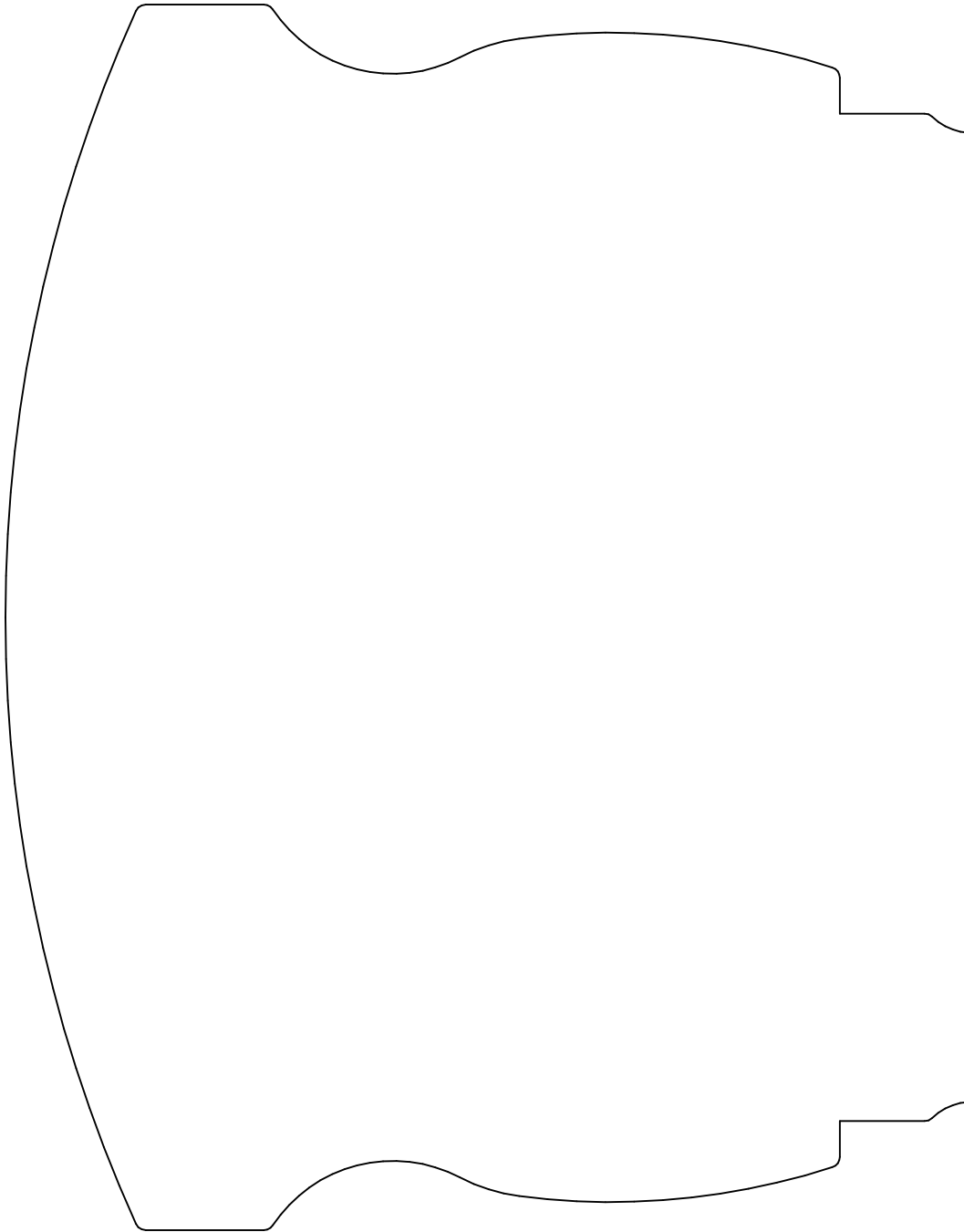

KL 1914
5.500 x 7.000

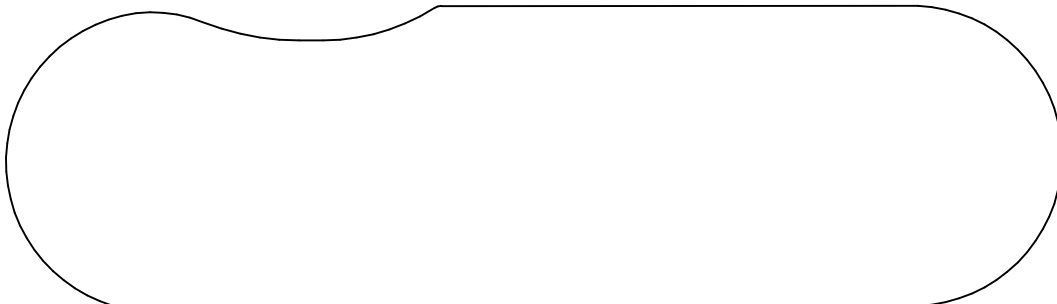

KL 1919
1.562 x 5.500

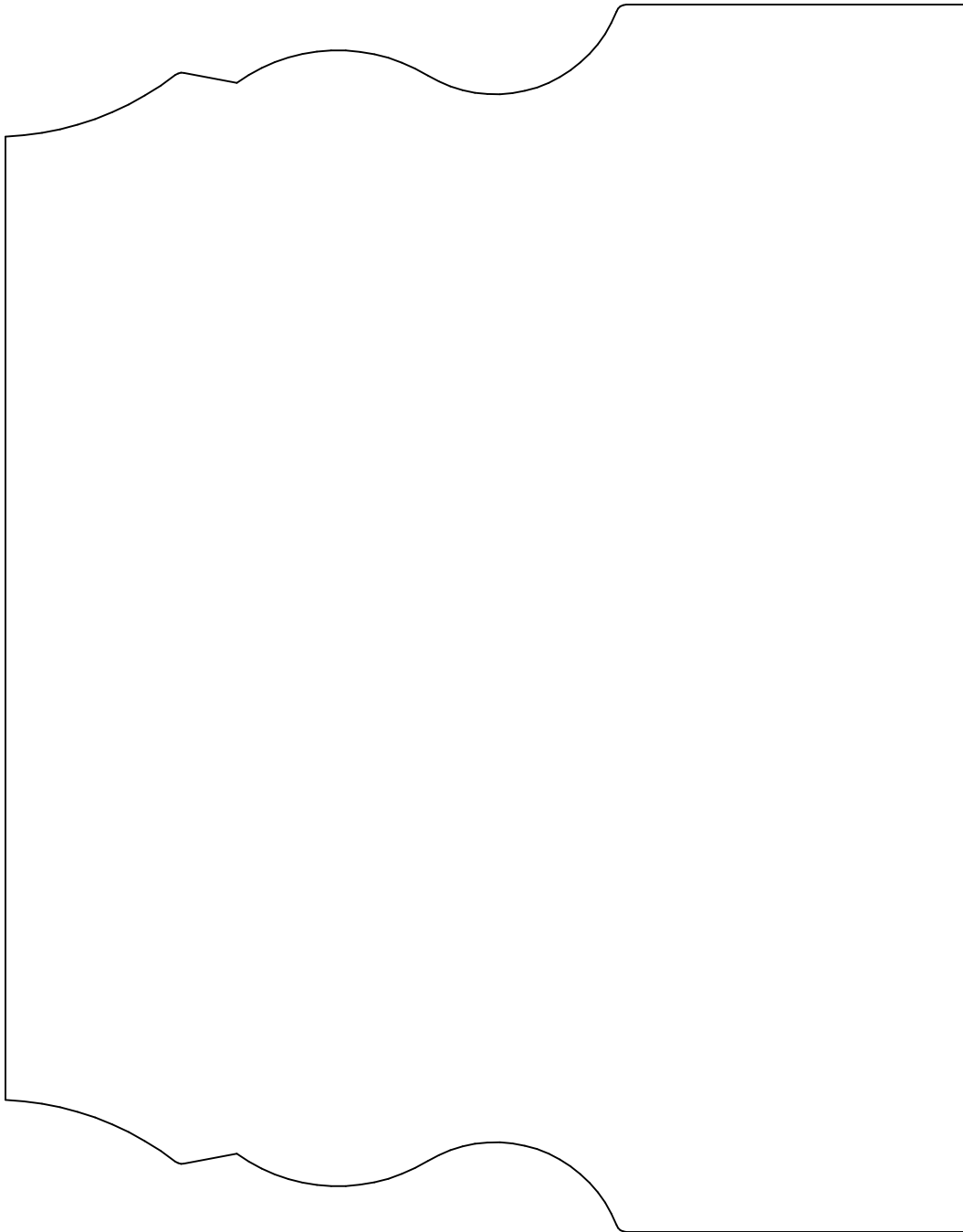

KL 1915
5.500 x 7.000

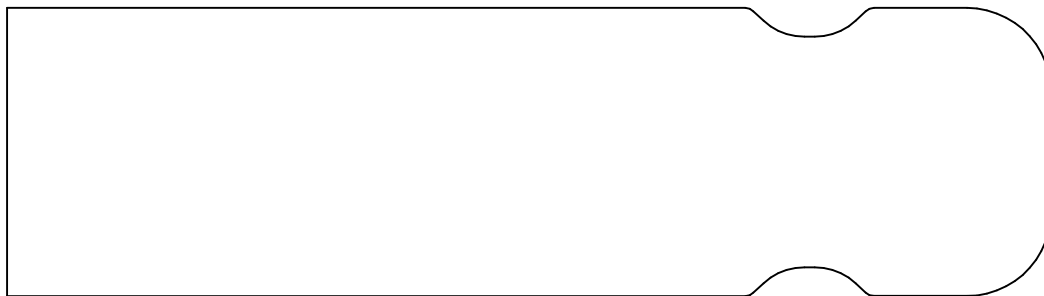

KL 1922
1.500 x 5.437

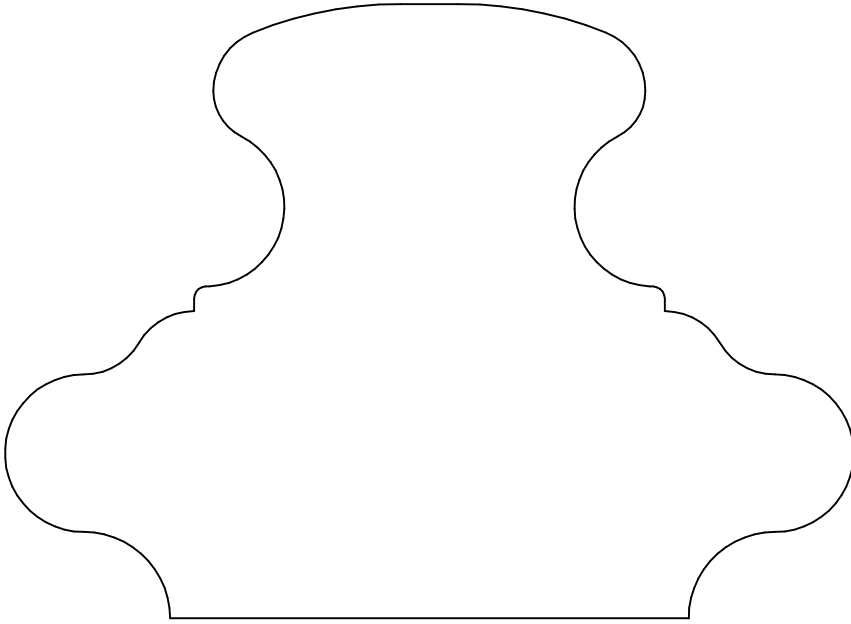

KL 1920
3.200 x 4.421

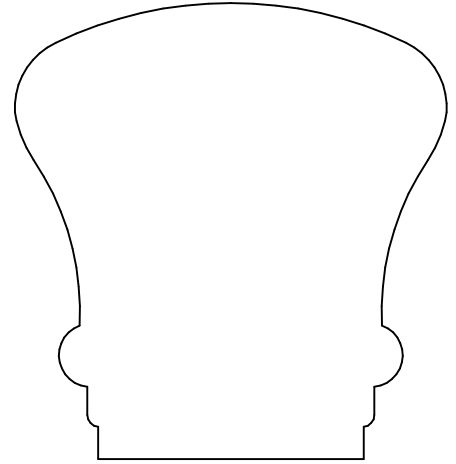

KL 1925
2.375 x 2.250

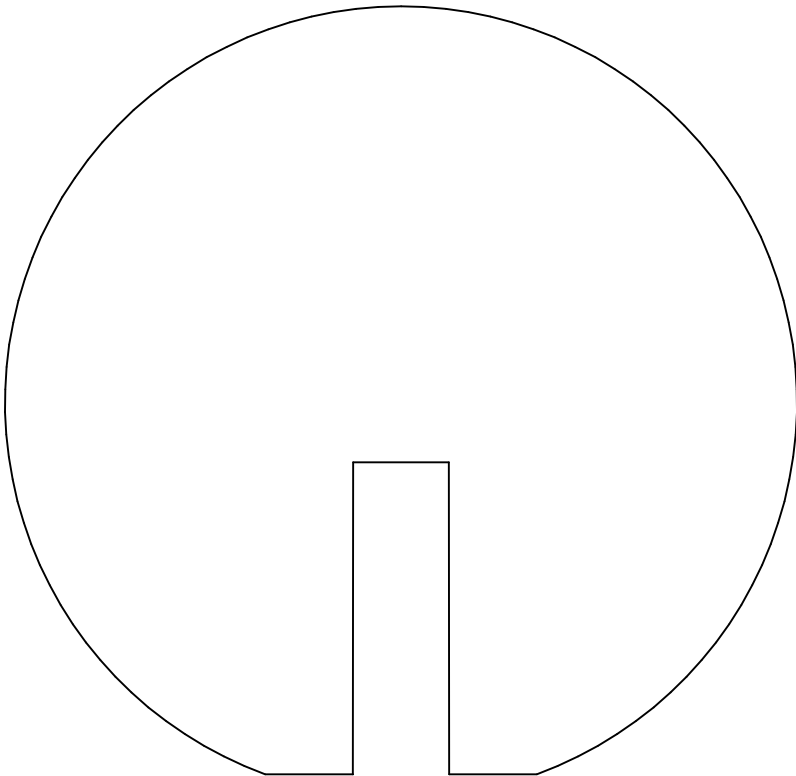

KL 1921P
4.000 x 4.125

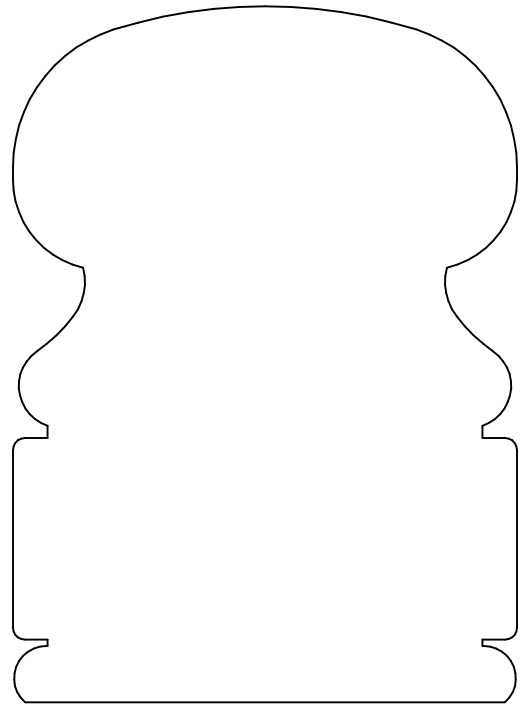

KL 1926
3.625 x 2.625

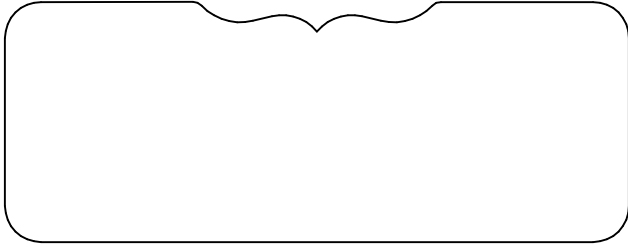

KL 1924
1.250 x 3.250

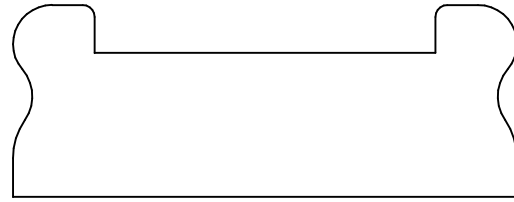

KL 1927P
1.000 x 2.625

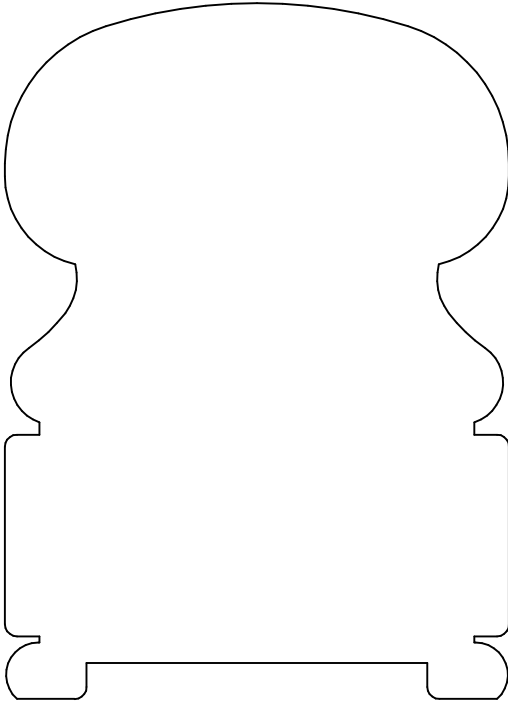

KL 1926P
3.625 x 2.625

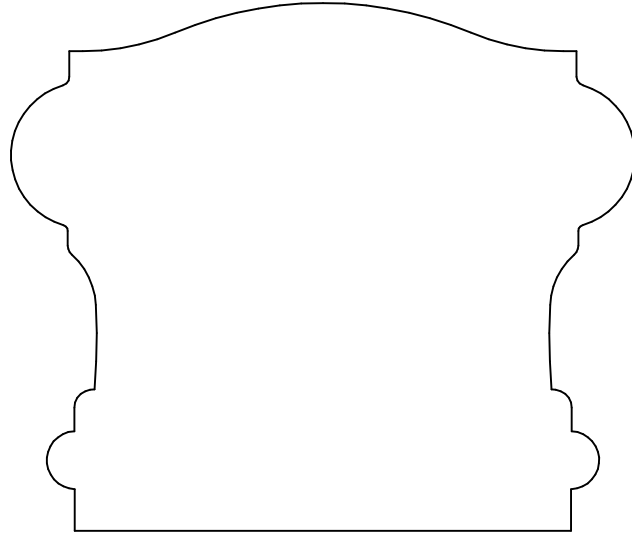

KL 1928
2.750 x 3.250

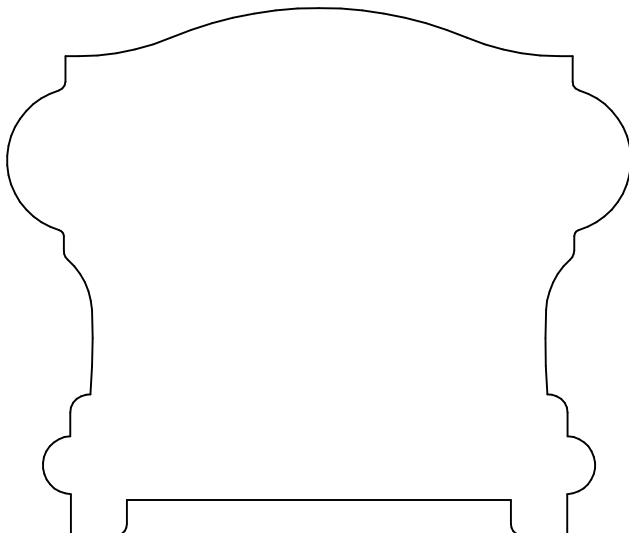

KL 1928P
2.750 x 3.250

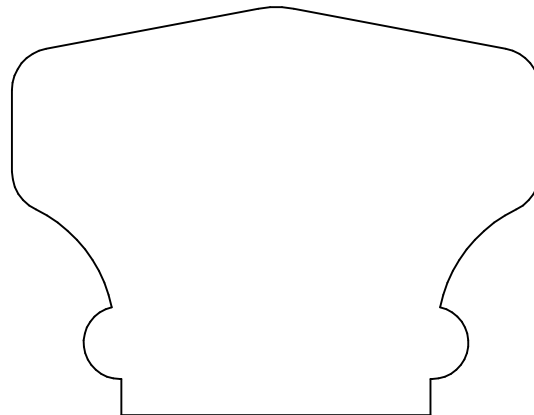

KL 1929_6701
2.125 x 2.750

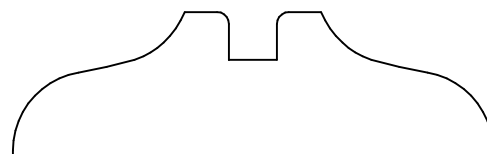

KL 1936
.750 x 2.500

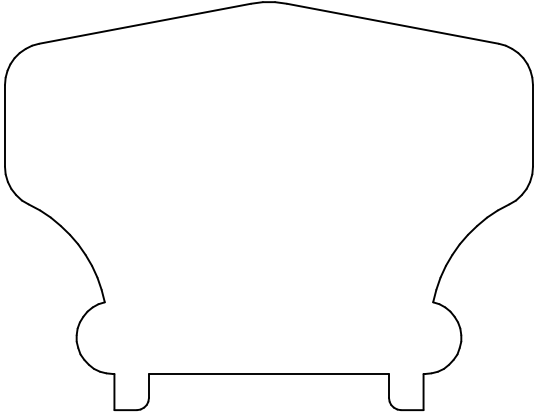

KL 1929P_6701P
2.125 x 2.750

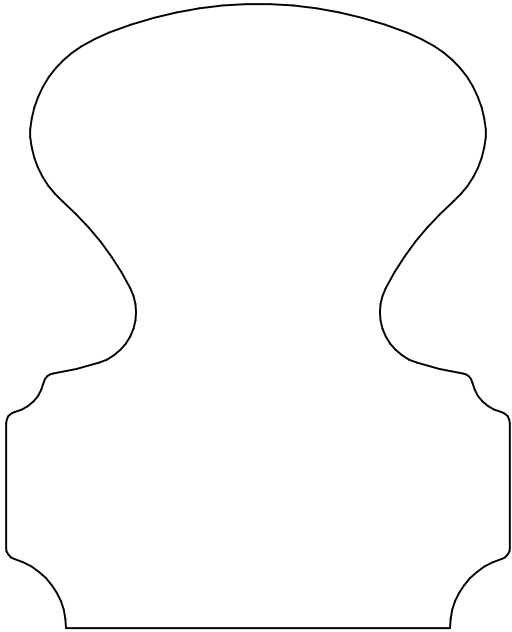

KL 1932
3.250 x 2.625

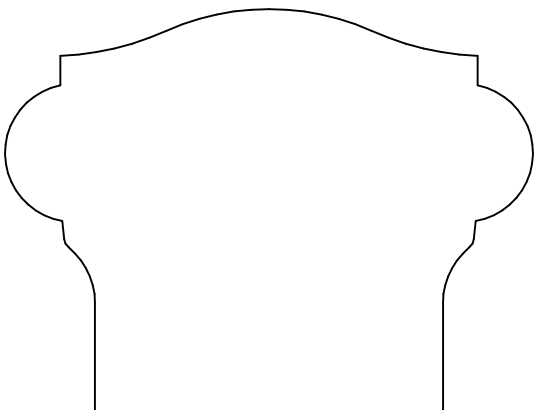

KL 1933
2.094 x 2.750

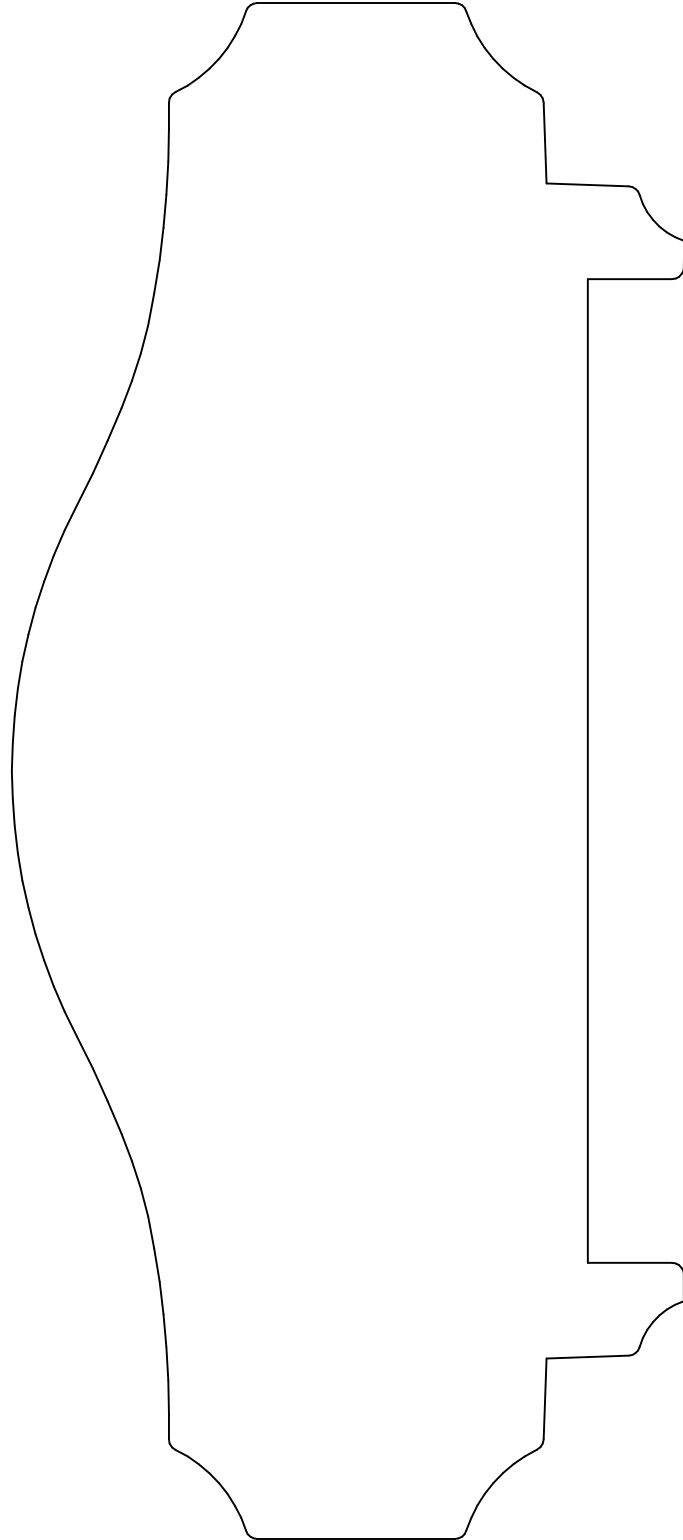

KL 1930P
3.500 x 8.000

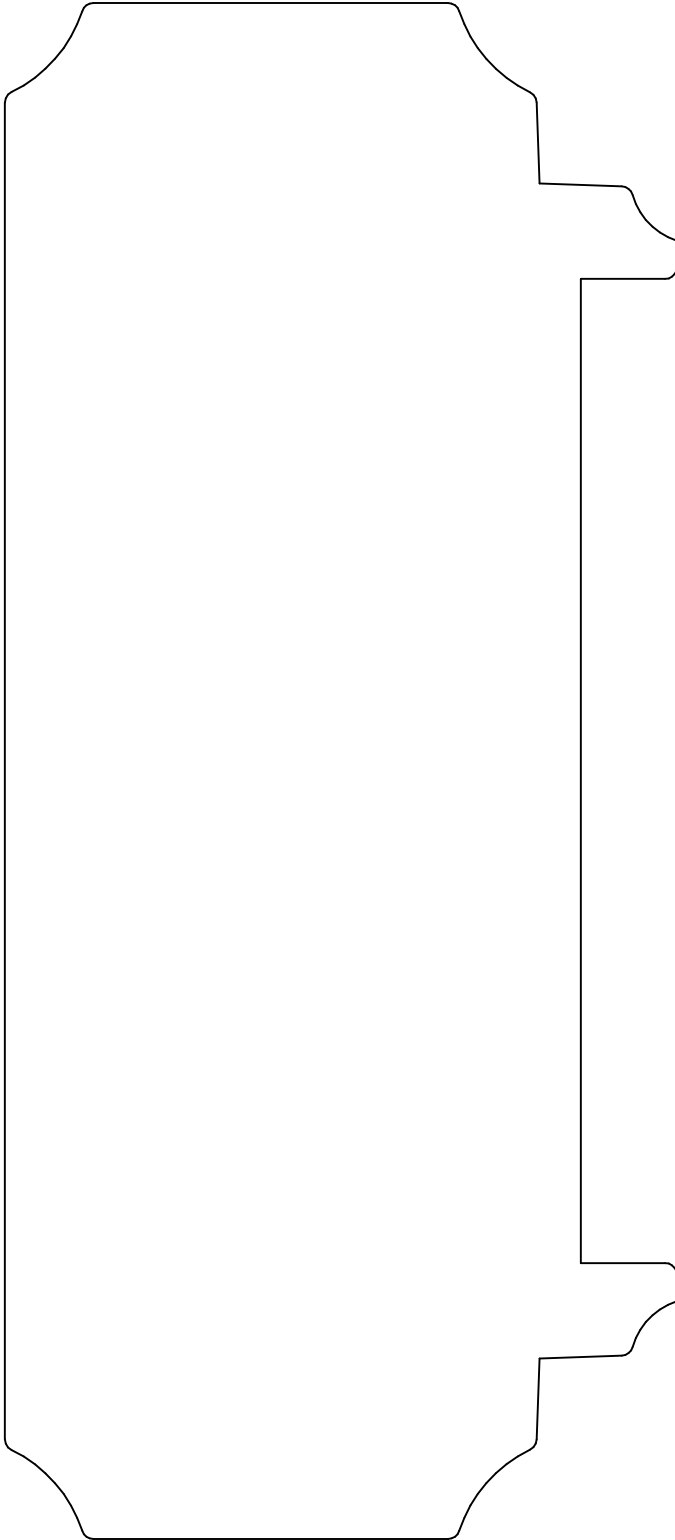

KL 1931P
3.500 x 8.000

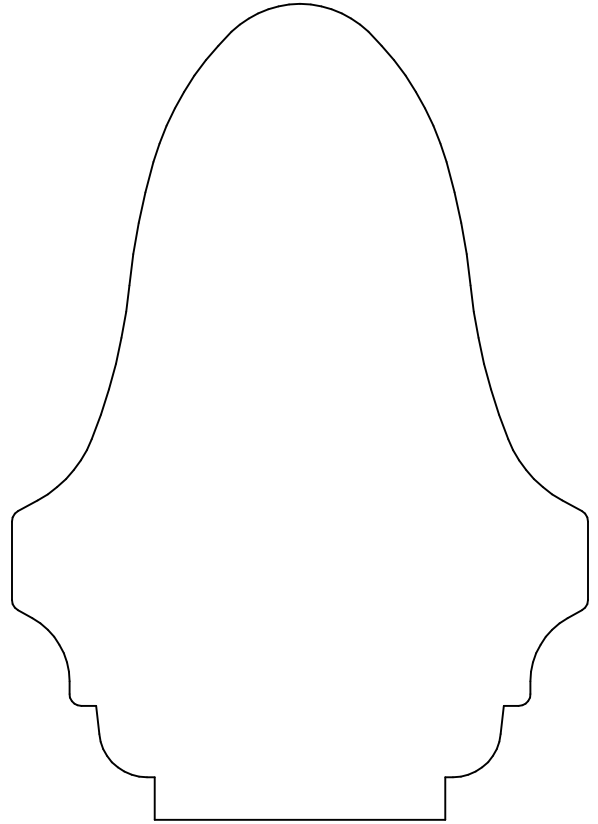

KL 1935
4.250 x 3.000

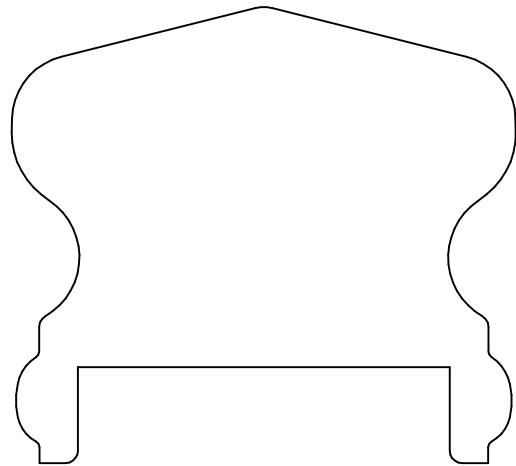

KL 1937P
2.375 x 2.623



KL 1950P
.687 x 2.000

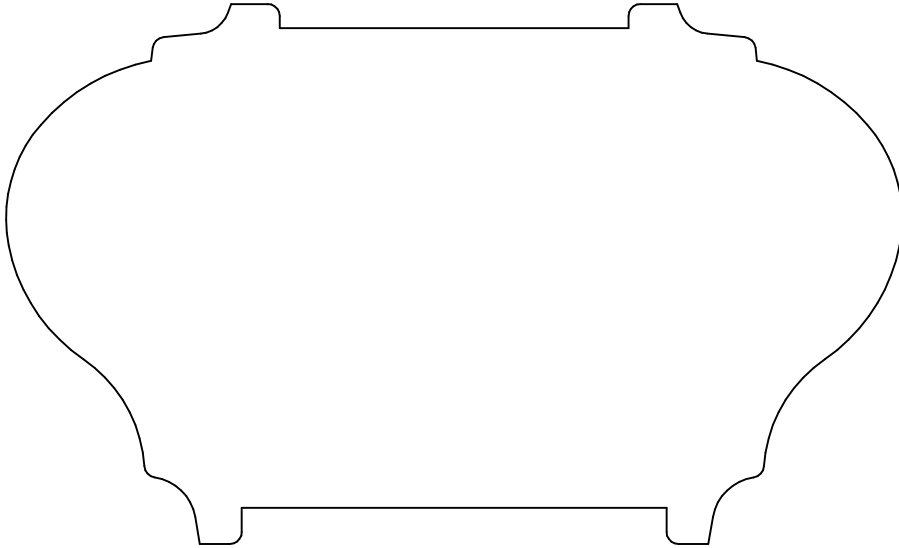

KL 1934P
2.812 x 4.668

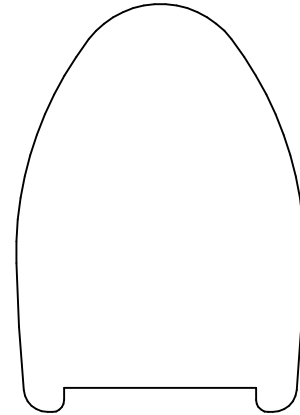

KL 1941P
2.125 x 1.500

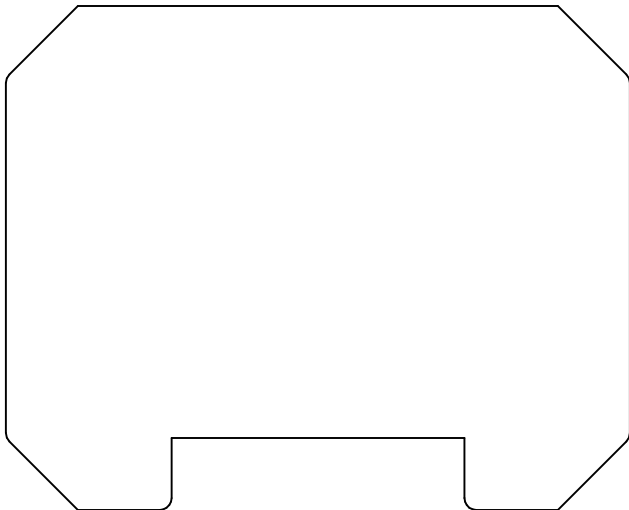

KL 1938P
2.625 x 3.250

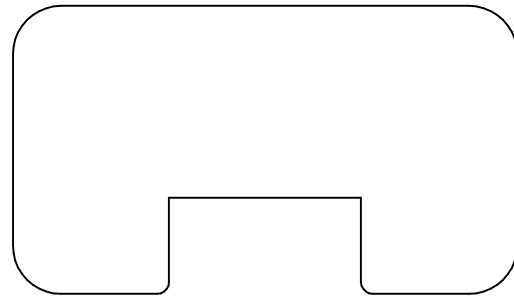

KL 1939P
1.500 x 2.625

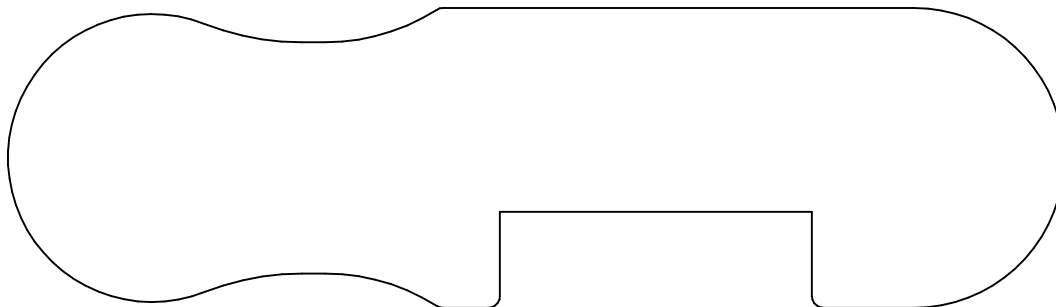

KL 1943
1.562 x 5.500

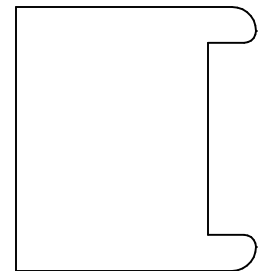

KL 1954P
1.375 x 1.250

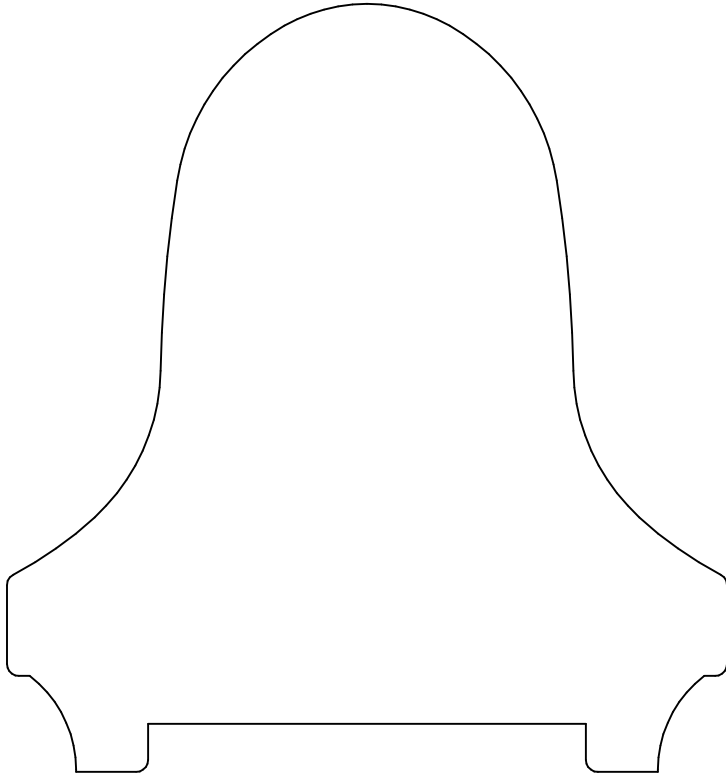

KL 1940P
4.000 x 3.750

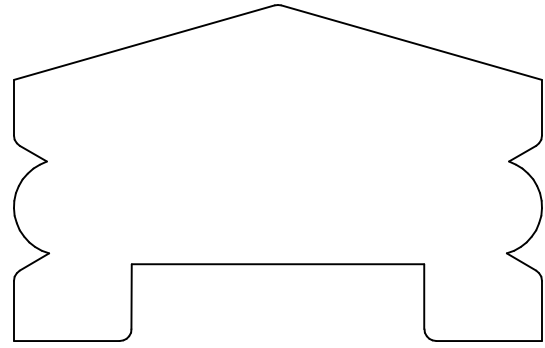

KL 1946P
1.750 x 2.750

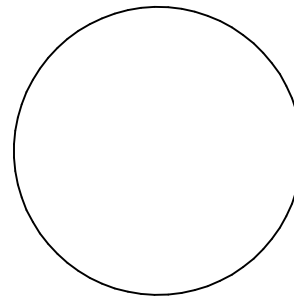

KL 1956
1.500 x 1.500

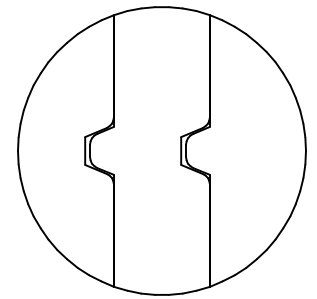

KL 1956B
1.500 x 1.500

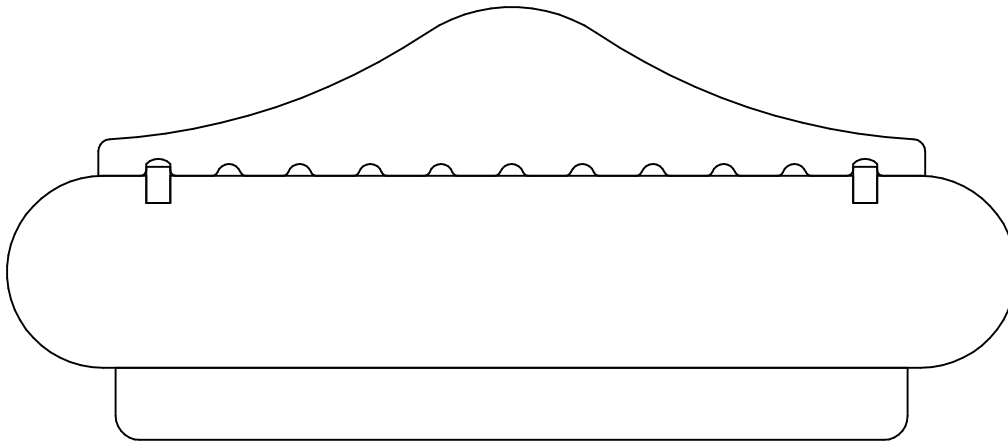

KL 1944
4.509 x 10.513



KL 1945
1.000 x 5.500

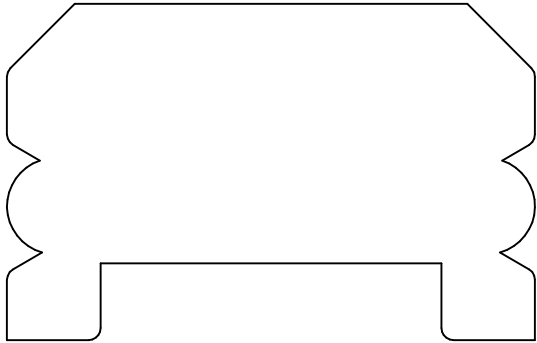

KL 1947P
1.750 x 2.750

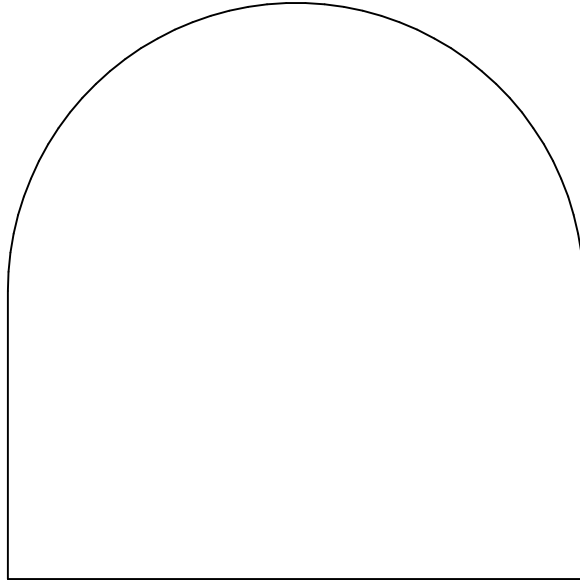

KL 1948
3.000 x 3.000

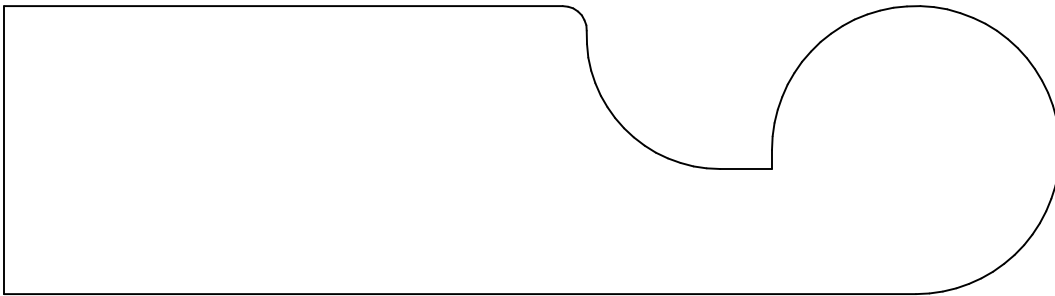

KL 1949
1.500 x 5.500

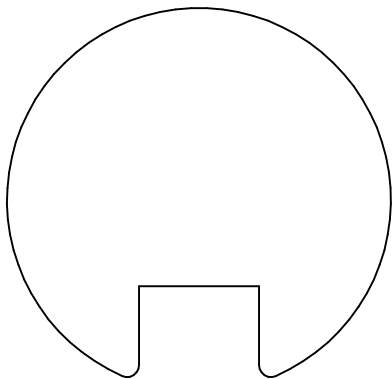

KL 1952P
1.922 x 2.000

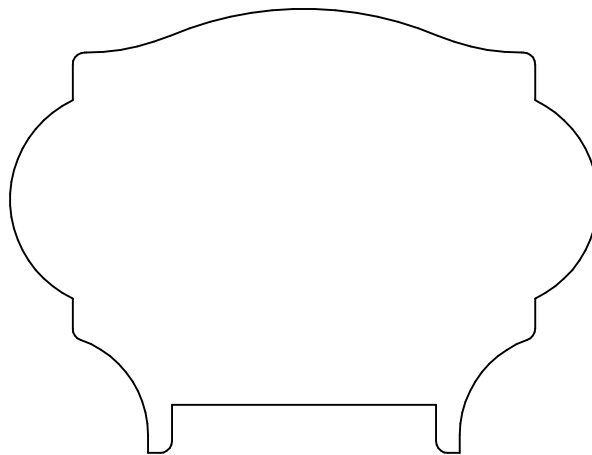

KL 1953P
2.312 x 3.062

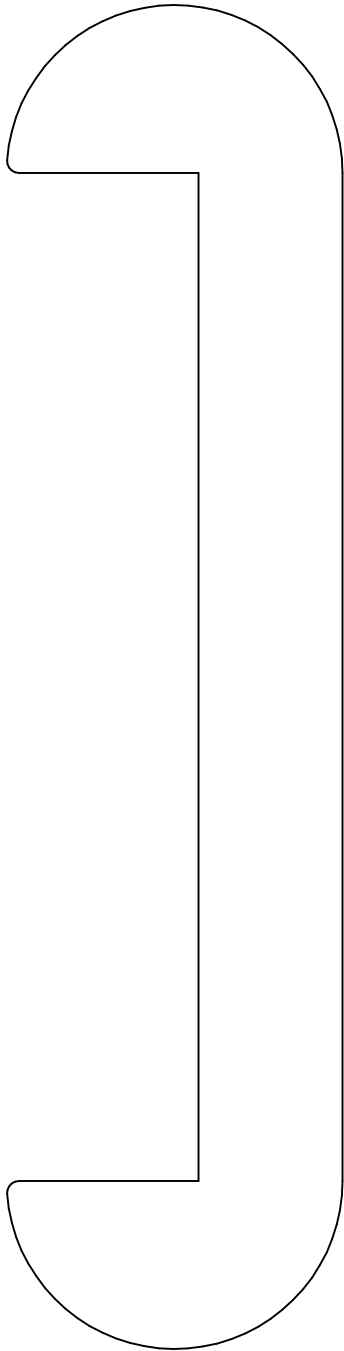

KL 1951
1.748 x 7.000

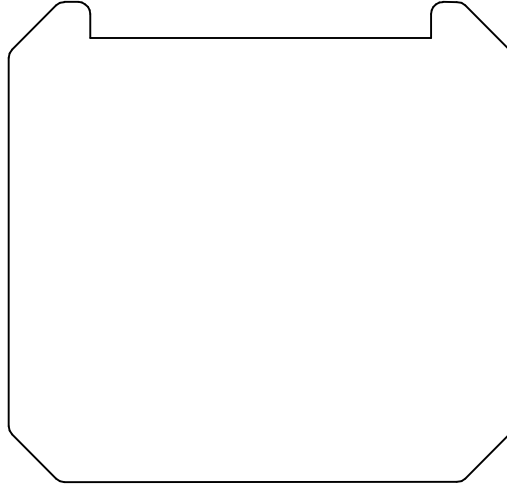

KL 1957P
2.500 x 2.625

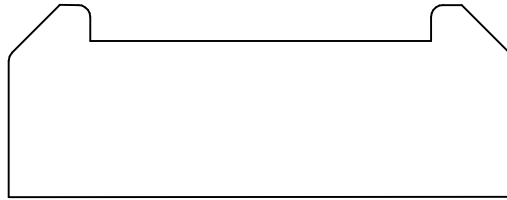

KL 1958P
1.000 x 2.625

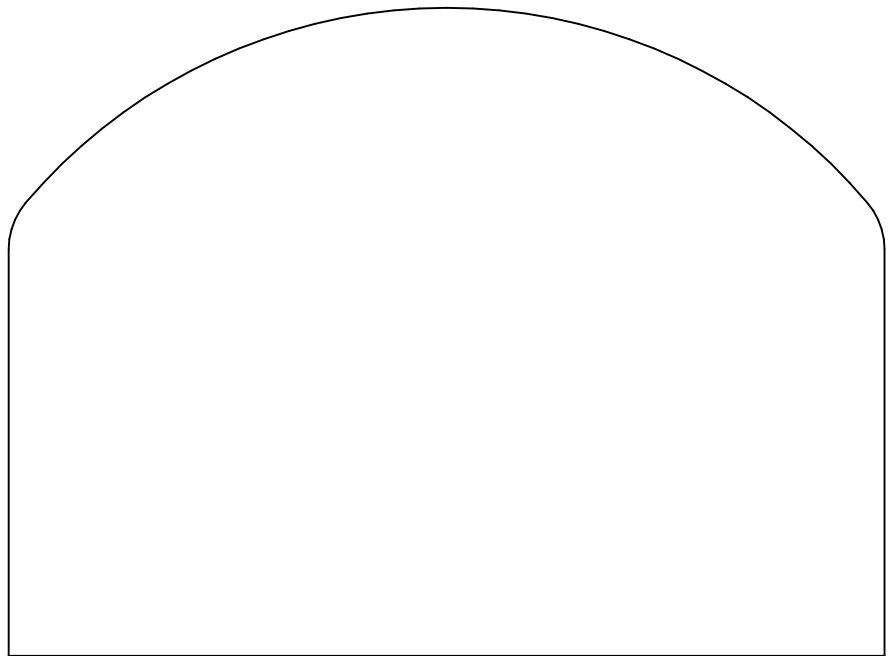

KL 1959
3.375 x 4.562

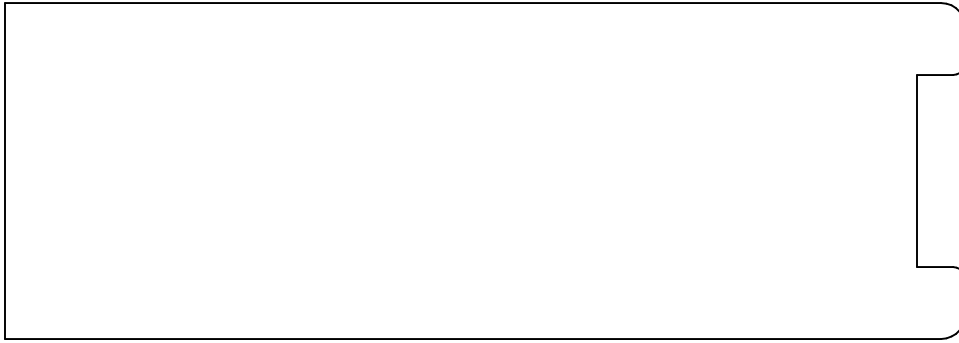

KL 1955P
1.750 x 5.000

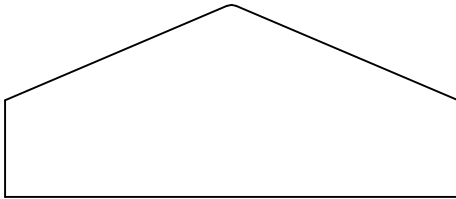

KL 1960
1.000 x 2.360

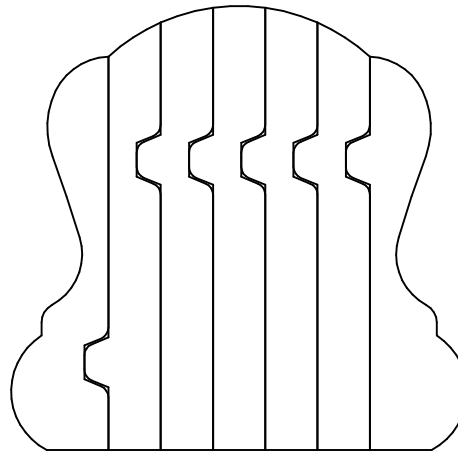

KL 1961B
2.312 x 2.375

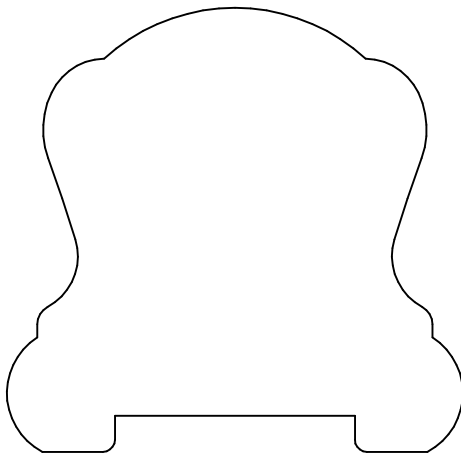

KL 1961P_6B10P
2.312 x 2.374

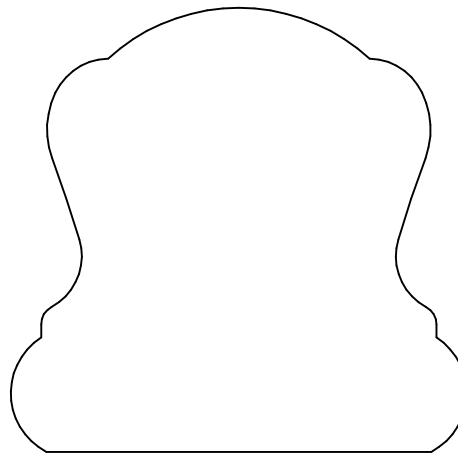

KL 1961_6B10
2.312 x 2.375

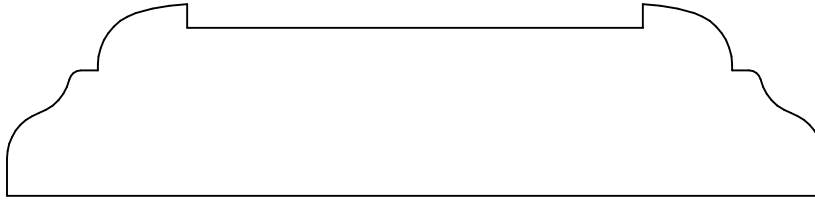

KL 1962P
1.000 x 4.250

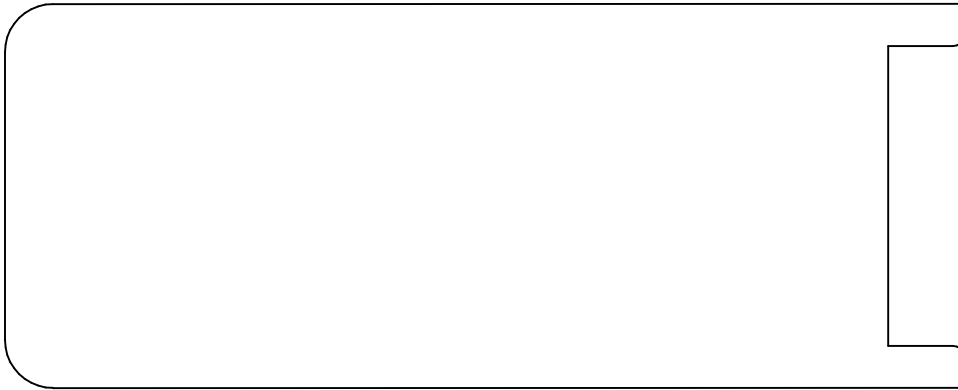

KL 1963P
2.000 x 5.000

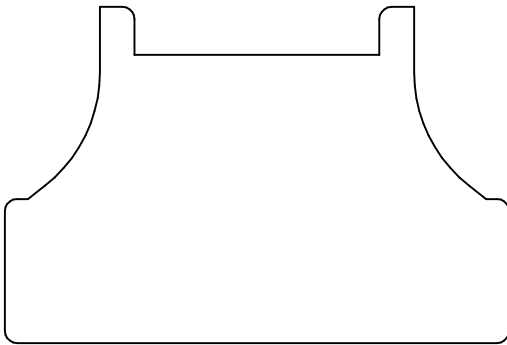

KL 1964P
1.750 x 2.625

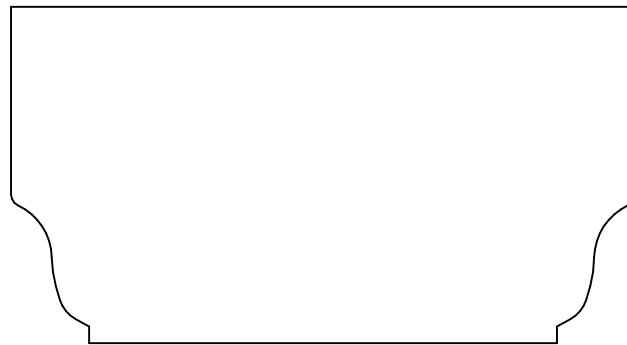

KL 1969
1.750 x 3.250

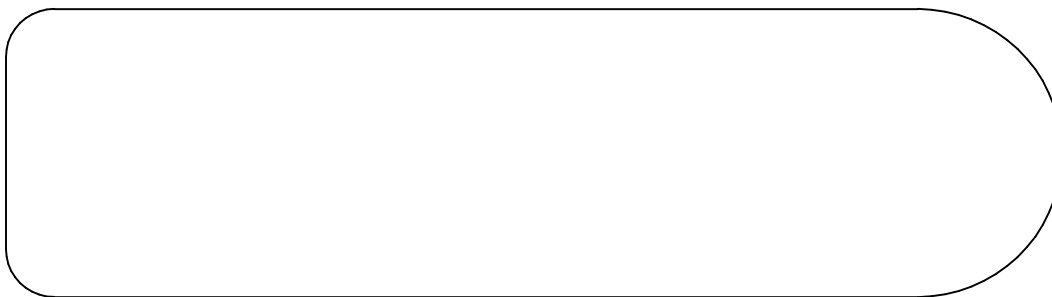

KL 1965
1.500 x 5.500

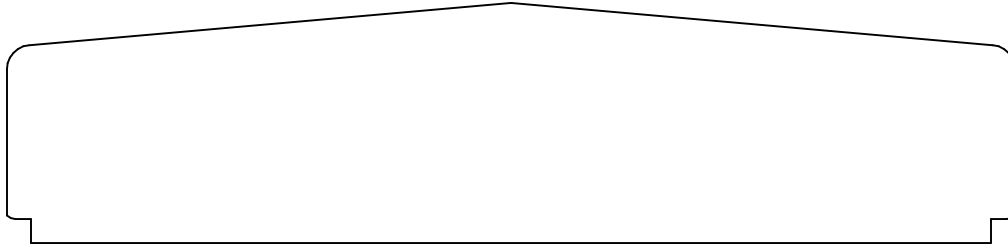

KL 1966
1.250 x 5.250

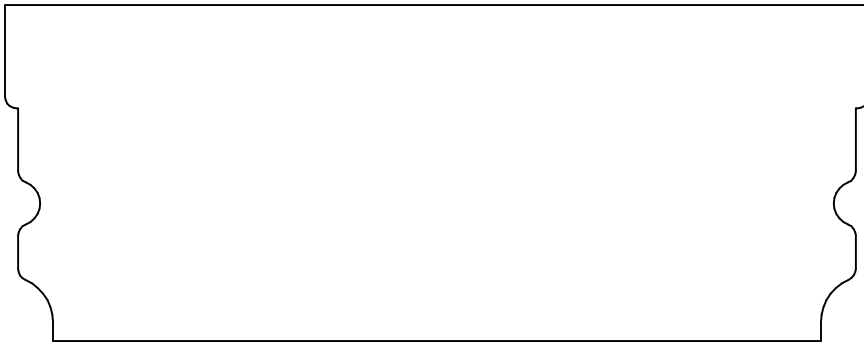

KL 1967
1.750 x 4.500

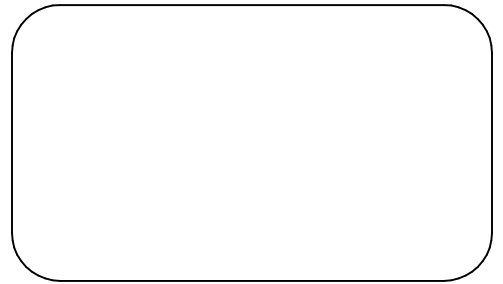

KL 1974
1.437 x 2.500

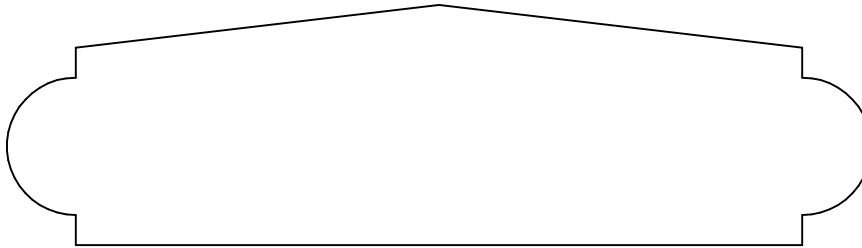

KL 1968
1.250 x 4.500

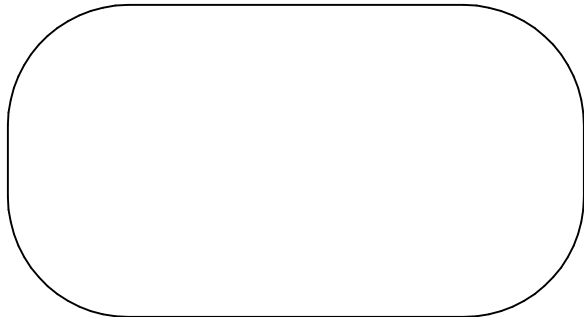

KL 1970
1.625 x 3.000

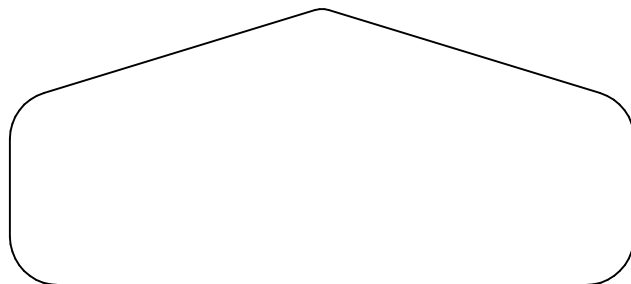

KL 1973
1.437 x 3.250

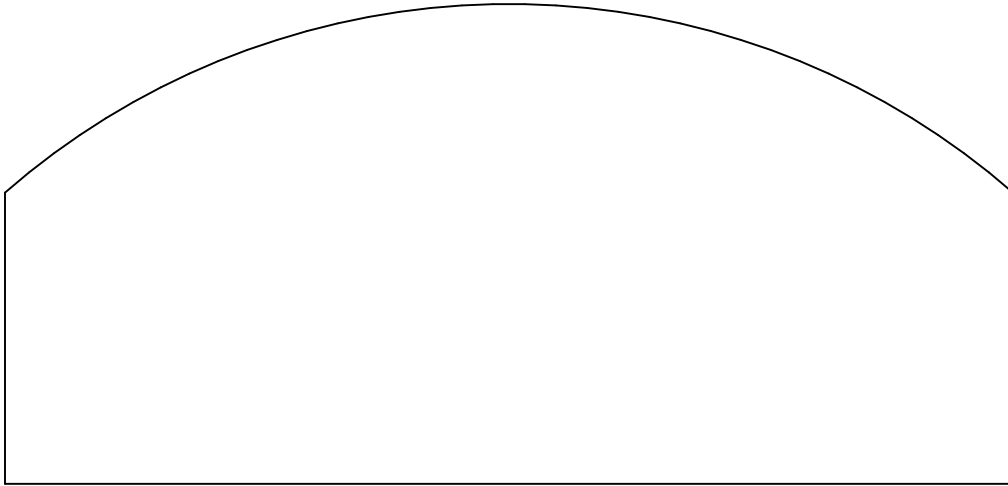

KL 1971
2.500 x 5.250

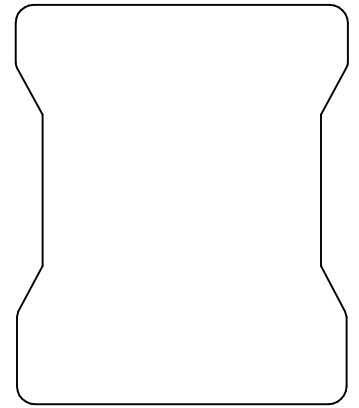

KL 1985
2.079 x 1.716

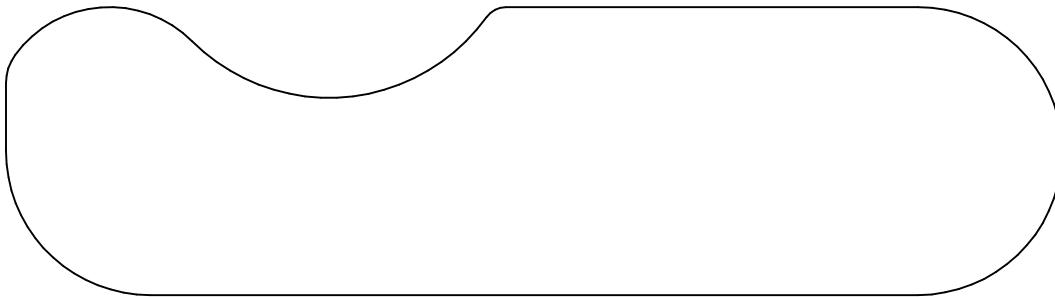

KL 1972
1.500 x 5.500

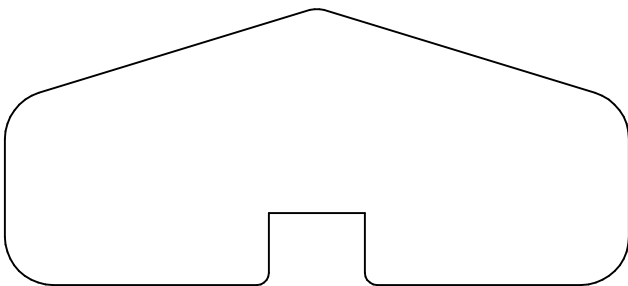

KL 1973P
1.437 x 3.250

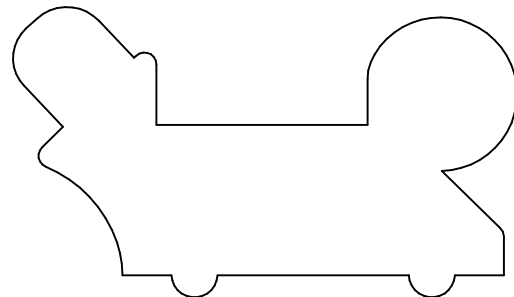

KL 1976
1.512 x 2.625

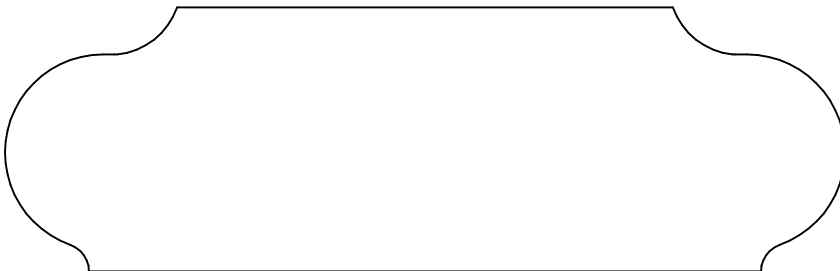

KL 1981
1.375 x 4.375

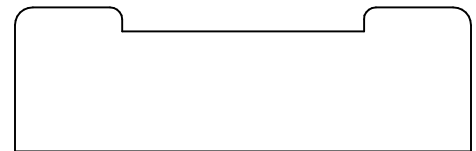

KL 1986P
.750 x 2.375

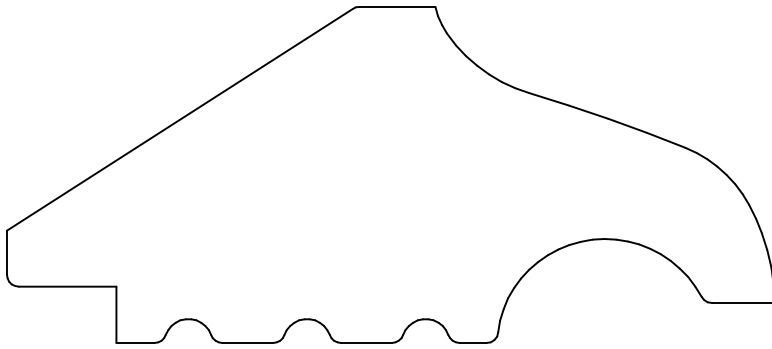

KL 1975
1.750 x 4.000

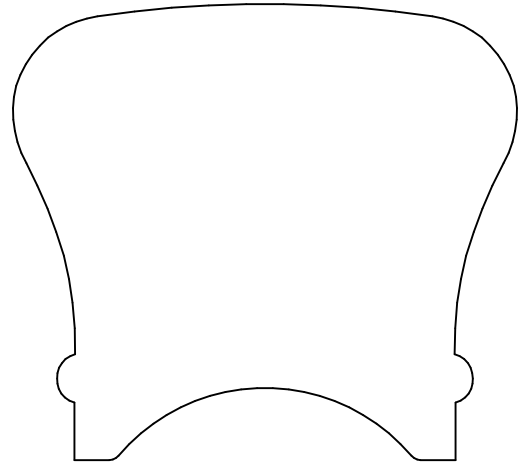

KL 1977
2.375 x 2.625

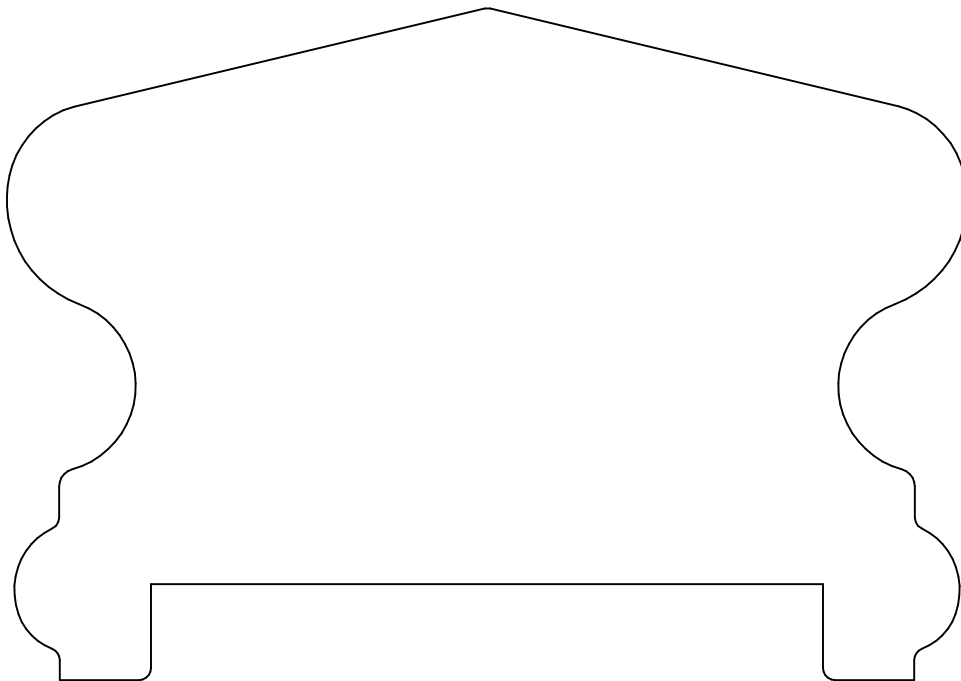

KL 1978P
3.500 x 5.000

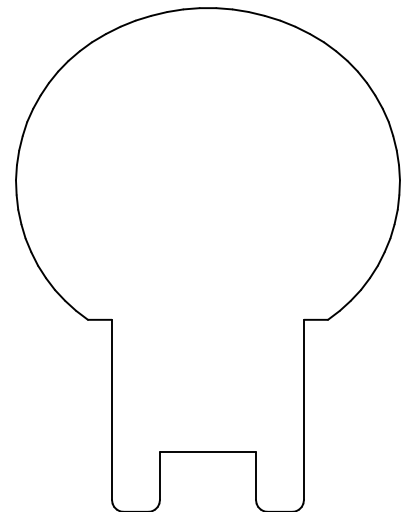

KL 1983P
2.625 x 2.000



KL 1988P
1.125 x 3.000

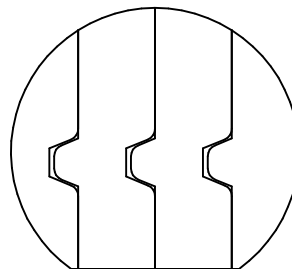

KL 1997B
1.359 x 1.500

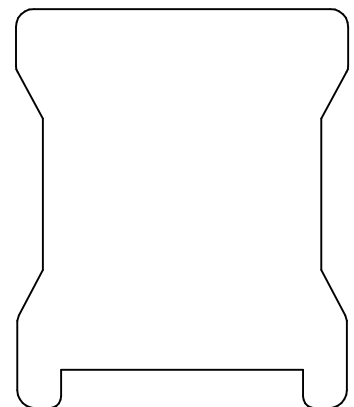

KL 1985P
2.079 x 1.730

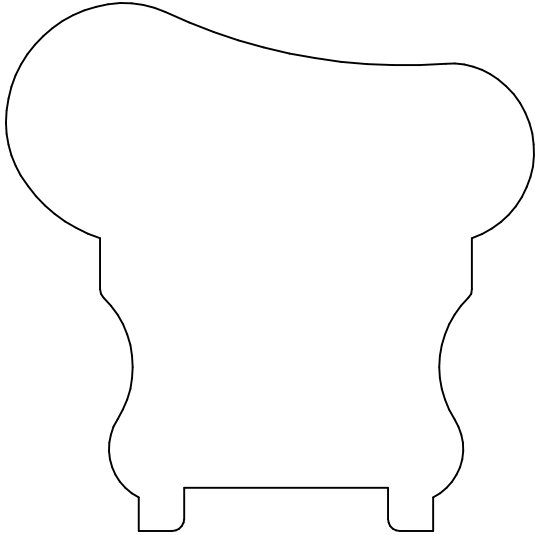

KL 1979P
2.750 x 2.750

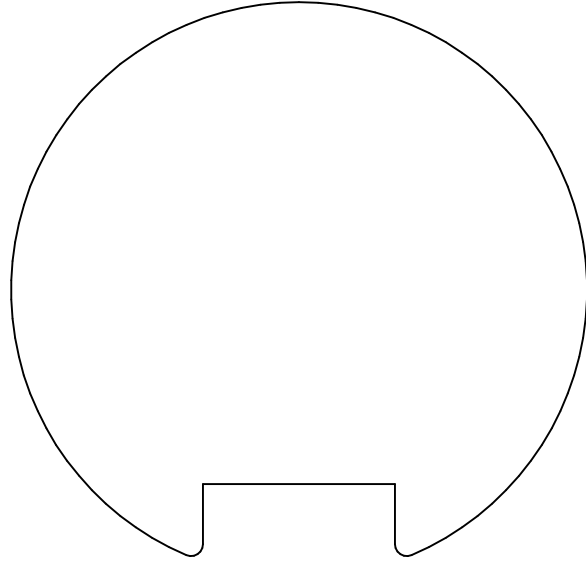

KL 1980P
2.886 x 3.000

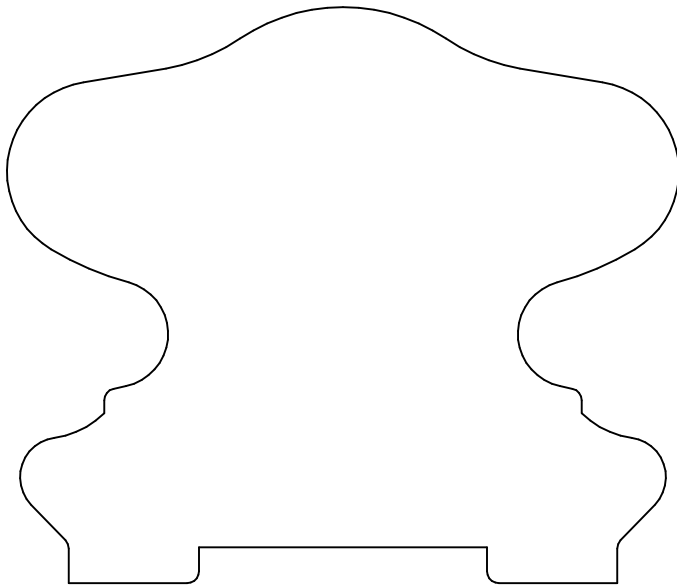

KL 1984P
3.000 x 3.500

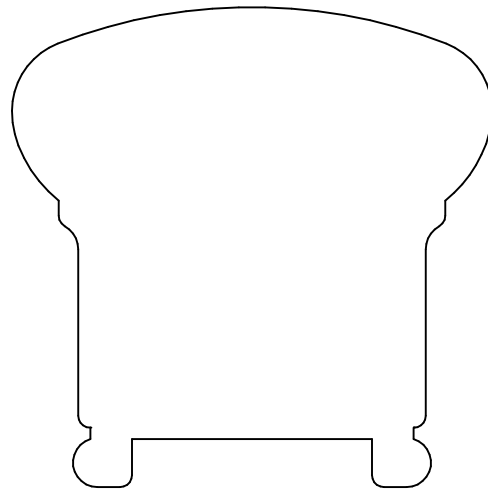

KL 1987P
2.500 x 2.500

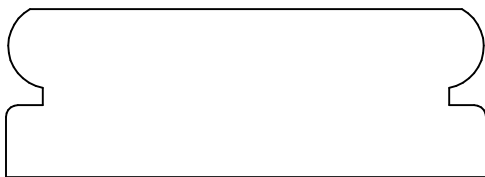

KL 1990
.875 x 2.500

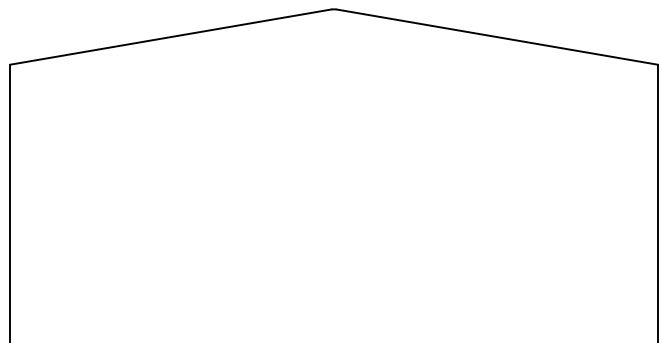

KL 1989
1.750 x 3.375

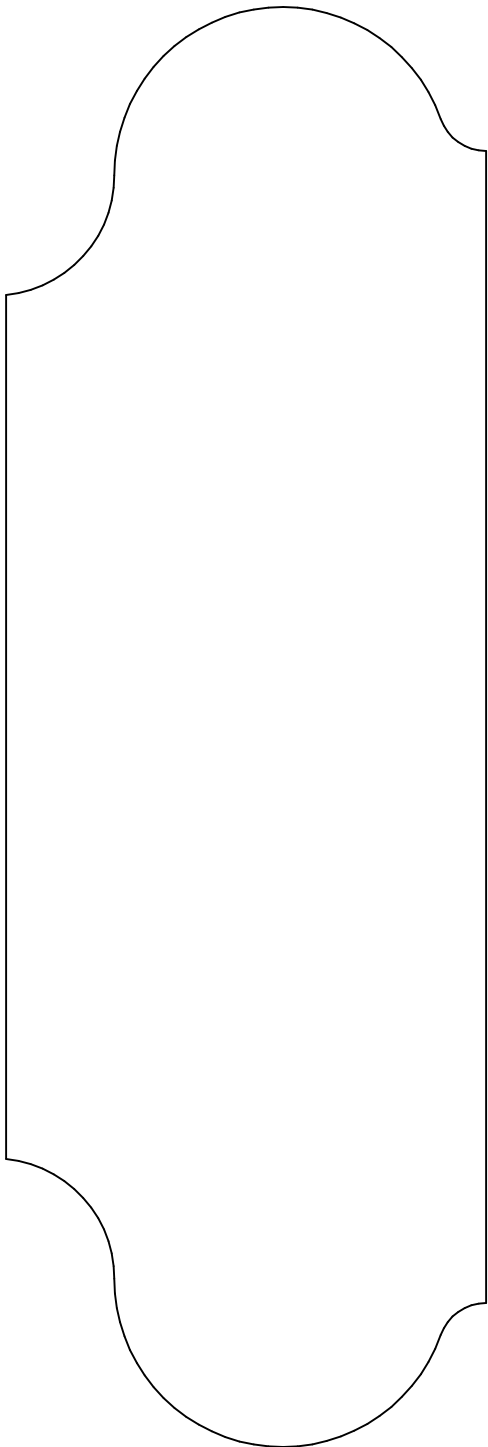

KL 1982
2.500 x 7.500



KL 1998
.312 x 1.750

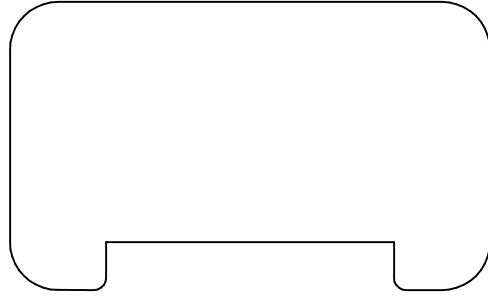

KL 1991P
1.500 x 2.500

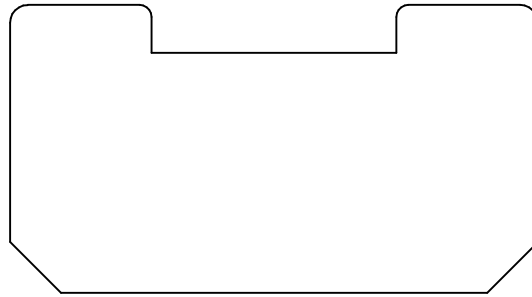

KL 1992P
1.500 x 2.750

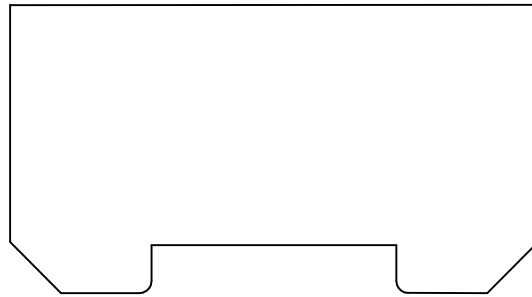

KL 1993P
1.500 x 2.750

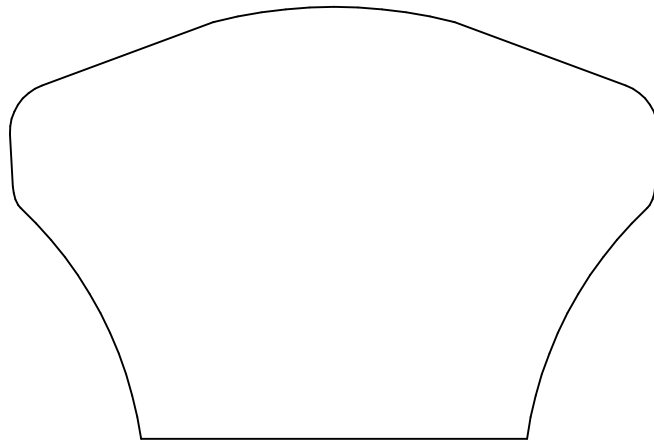

KL 1995
2.250 x 3.375

CUSTOM PROFILES

Handrail

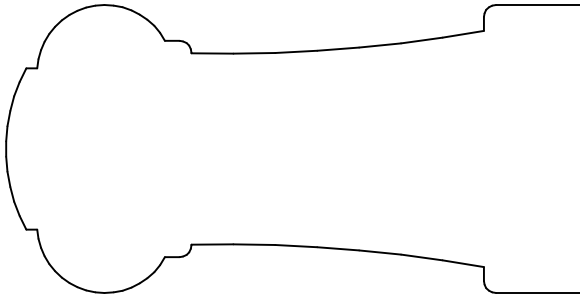

KL 1994
1.500 x 3.000

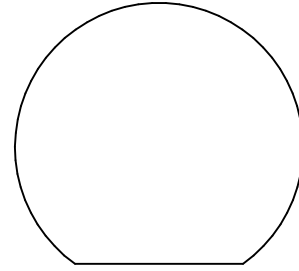

KL 1997
1.359 x 1.500

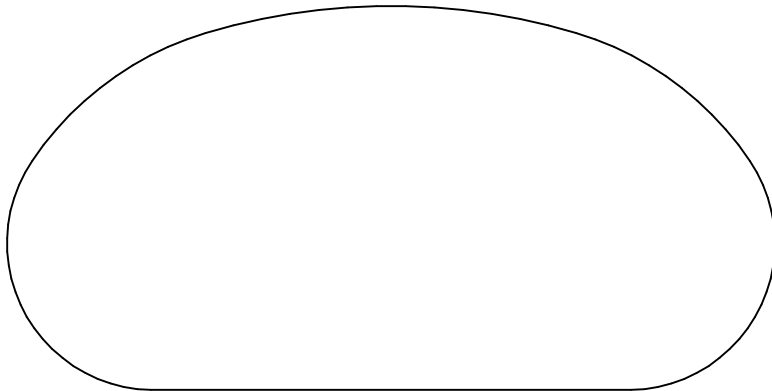

KL 1996
2.000 x 4.000

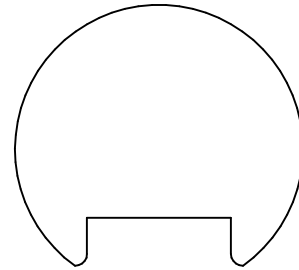

KL 1997P
1.359 x 1.500

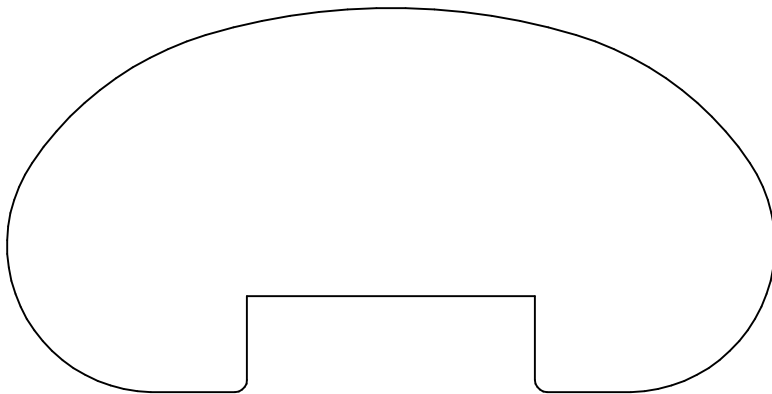

KL 1996P
2.000 x 4.000

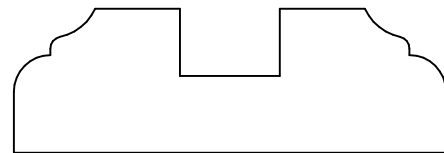

KL 3901P
.750 x 2.250

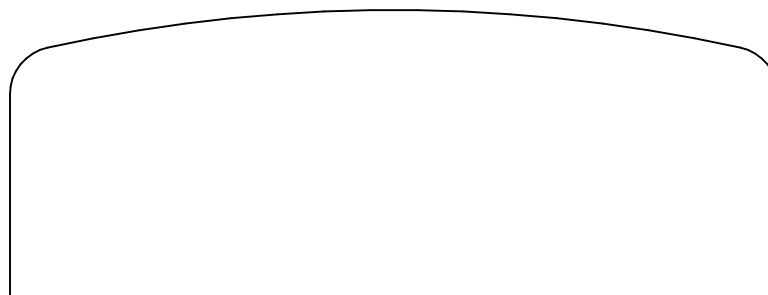

KL 3900
1.500 x 4.000

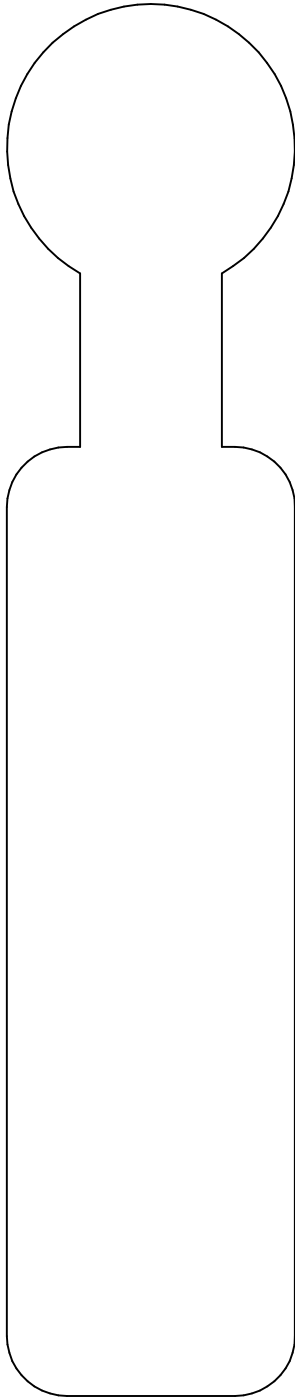

KL 1999
1.500 x 7.250

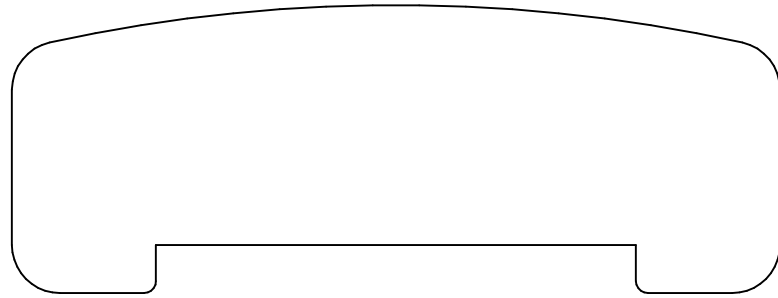

KL 3900P
1.500 x 4.000

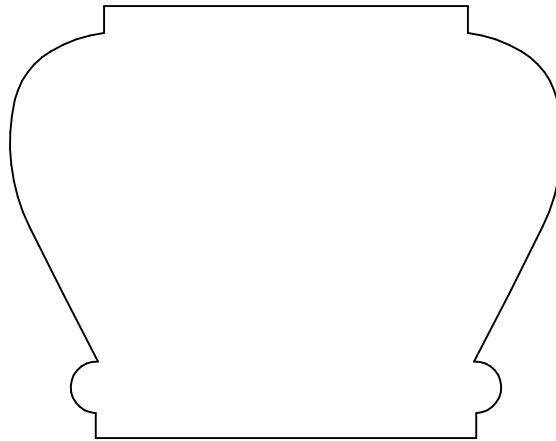

KL 3902
2.250 x 2.875

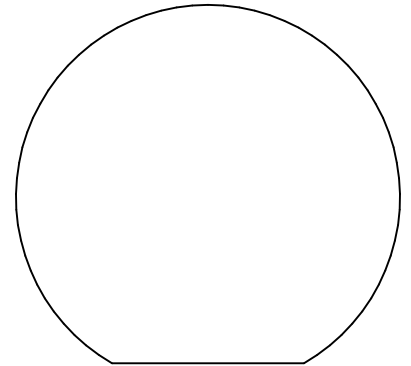

KL 3907
1.866 x 2.000

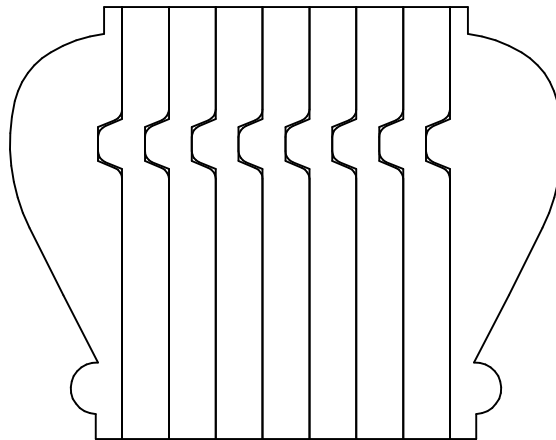

KL 3902B
2.250 x 2.875

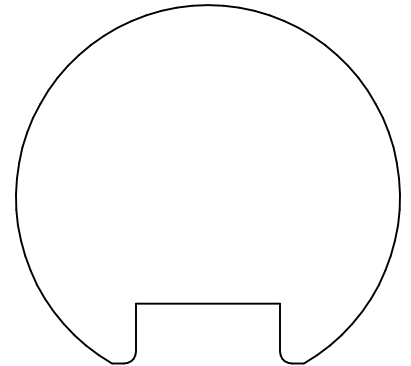

KL 3907P
1.866 x 2.000

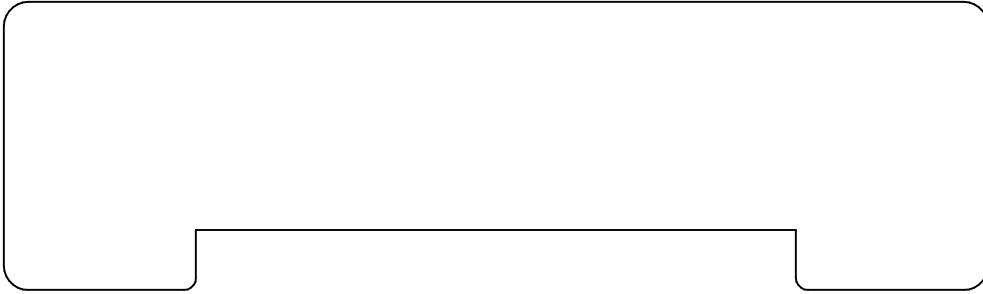

KL 3903P
1.500 x 5.125

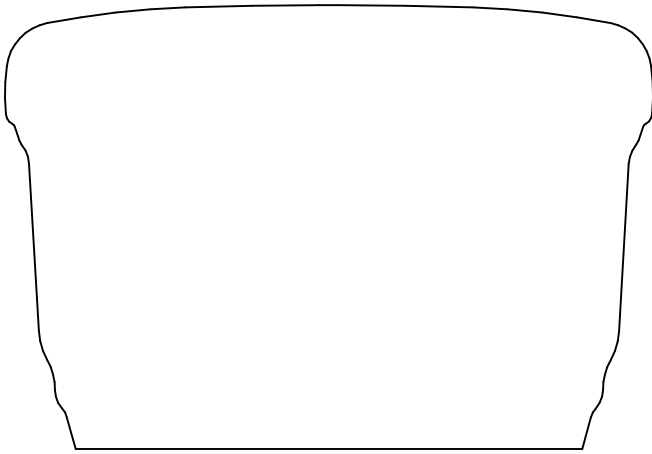

KL 3904
2.312 x 3.375

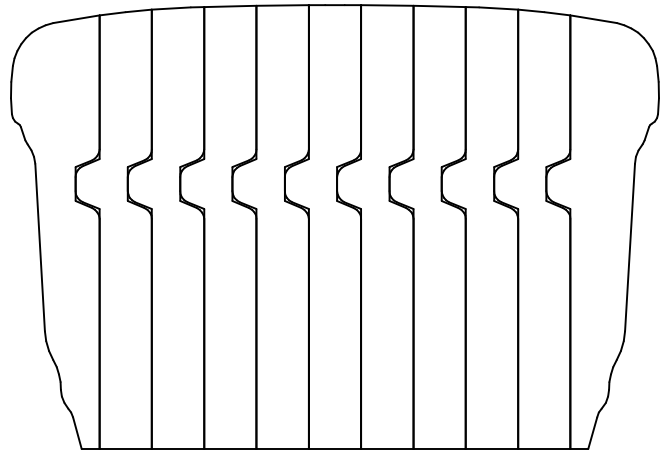

KL 3904B
2.312 x 3.375

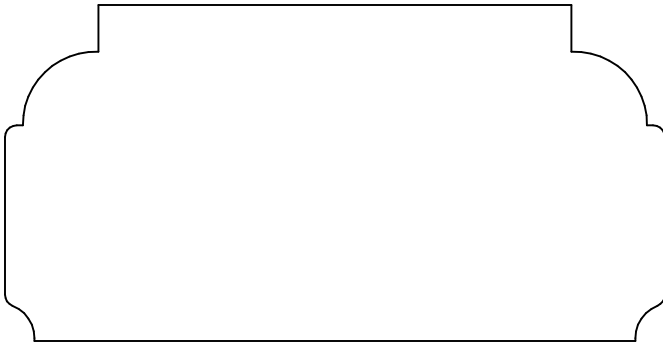

KL 3905
1.750 x 3.437

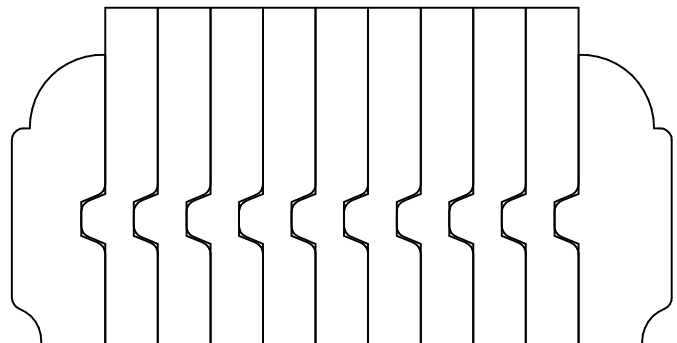

KL 3905B
1.750 x 3.437

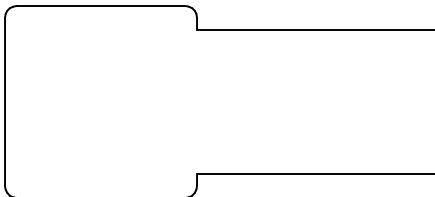

KL 3910
1.000 x 2.250

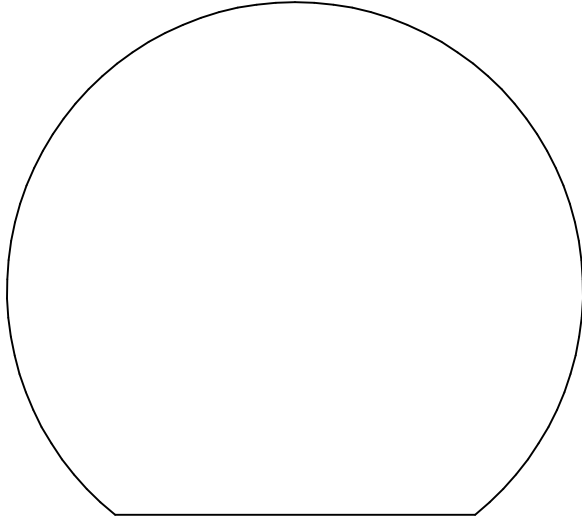

KL 3906
2.671 x 3.000

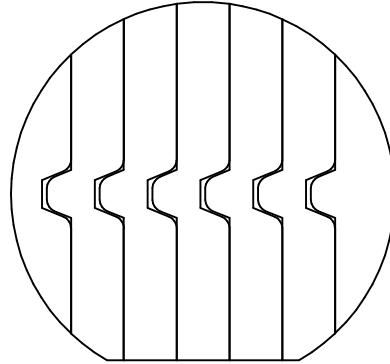

KL 3907B
1.866 x 2.000

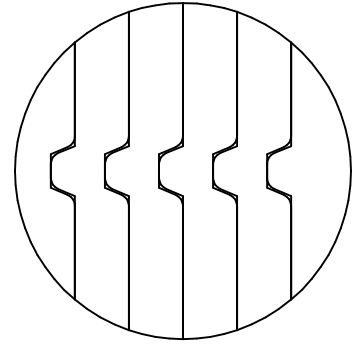

KL 3913B
1.750 x 1.750

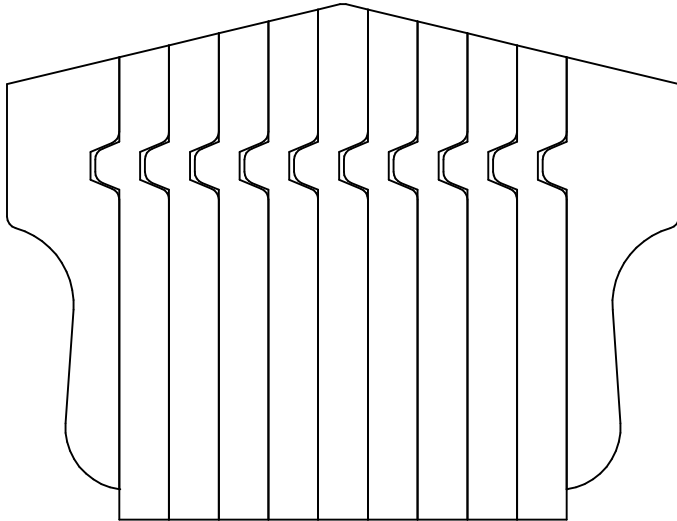

KL 3908B
2.687 x 3.500

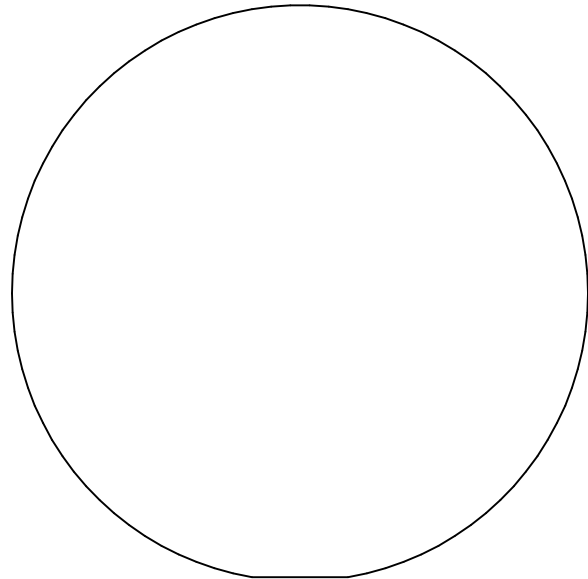

KL 3909
2.979 x 3.000

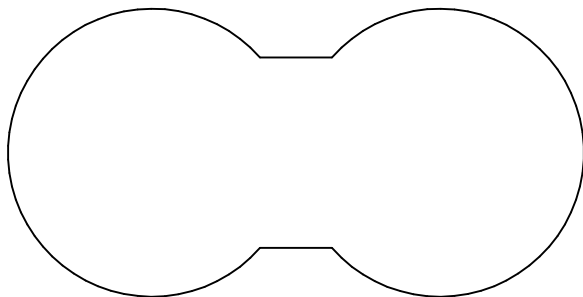

KL 3911
1.500 x 3.000

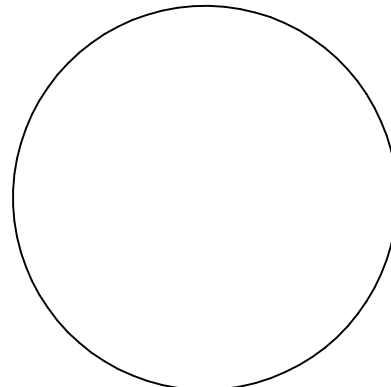

KL 3912
2.000 x 2.000

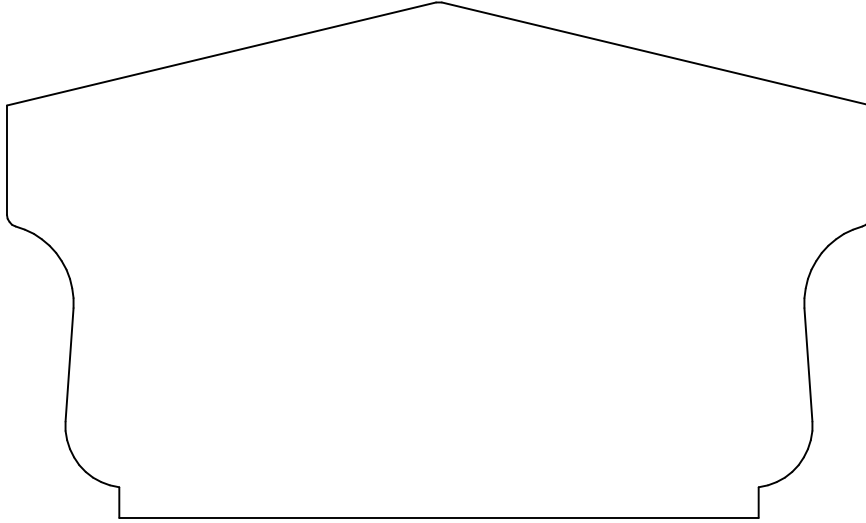

KL 3908
2.687 x 4.500

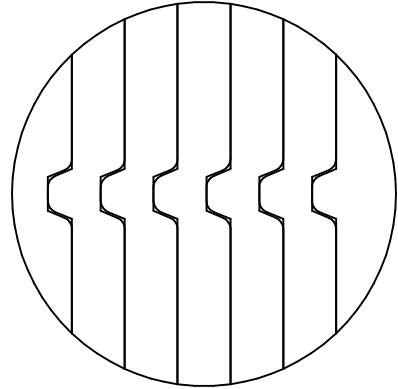

KL 3912B
2.000 x 2.000

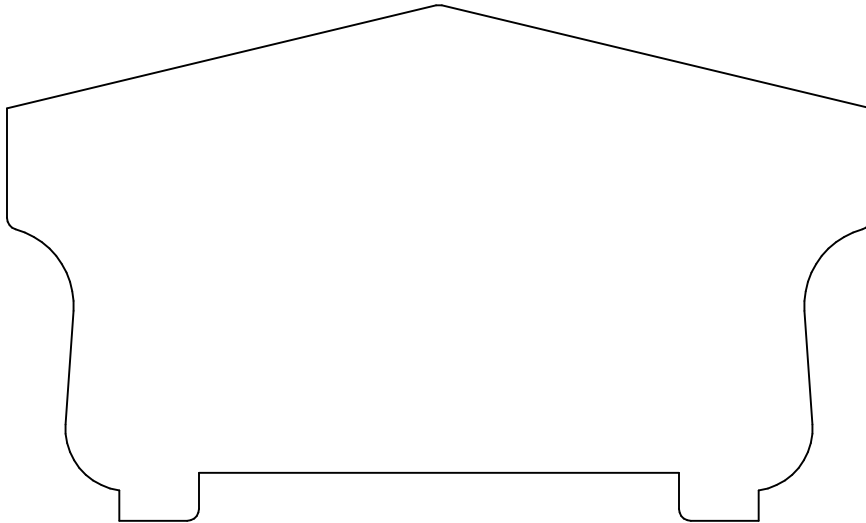

KL 3908P
2.687 x 4.500

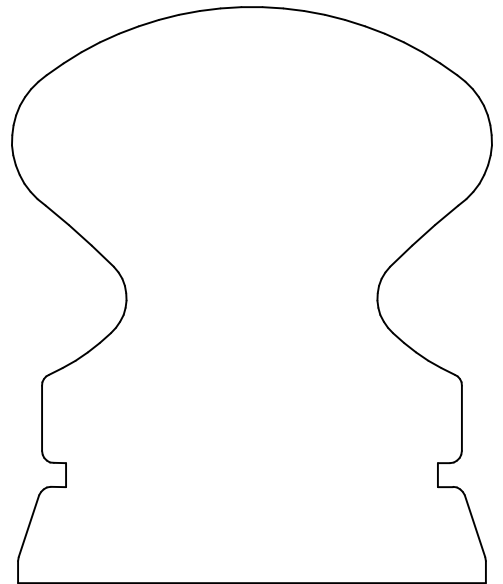

KL 3922
3.000 x 2.500

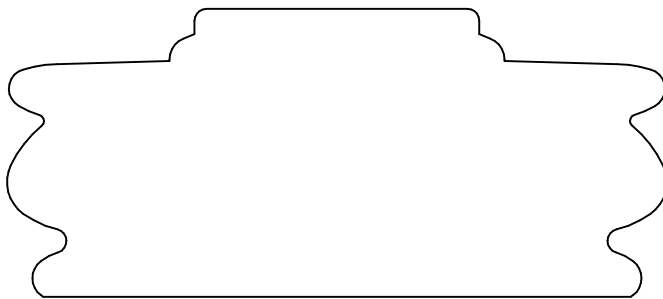

KL 3915
1.500 x 3.437

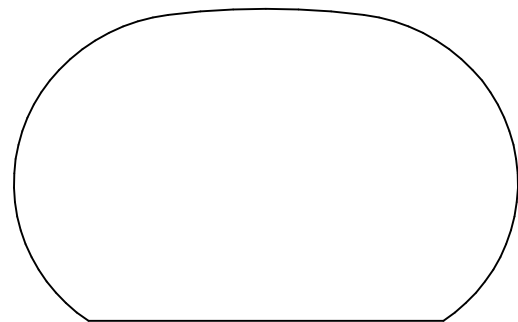

KL 3917
1.625 x 2.625

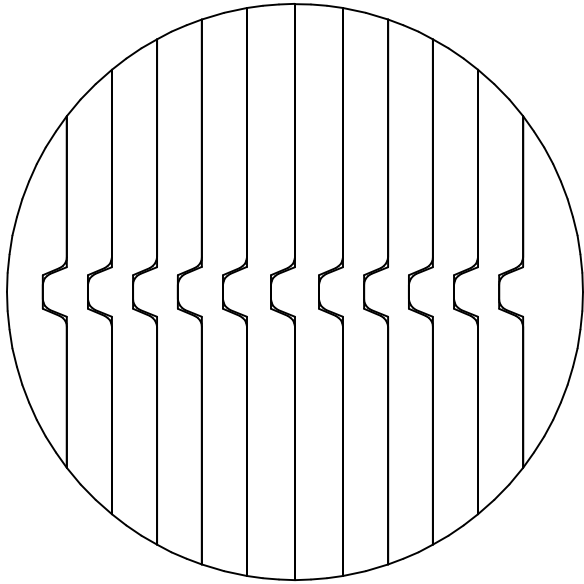

KL 3909B
3.000 x 3.000

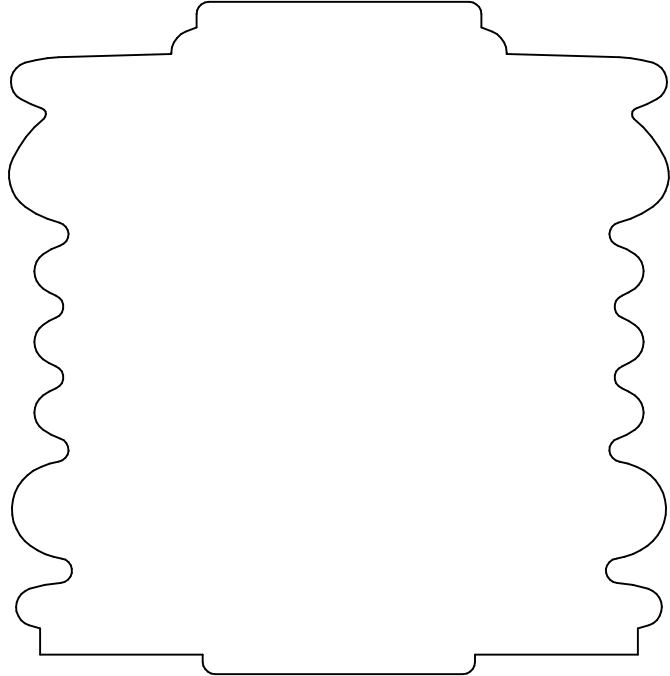

KL 3914
3.500 x 3.437

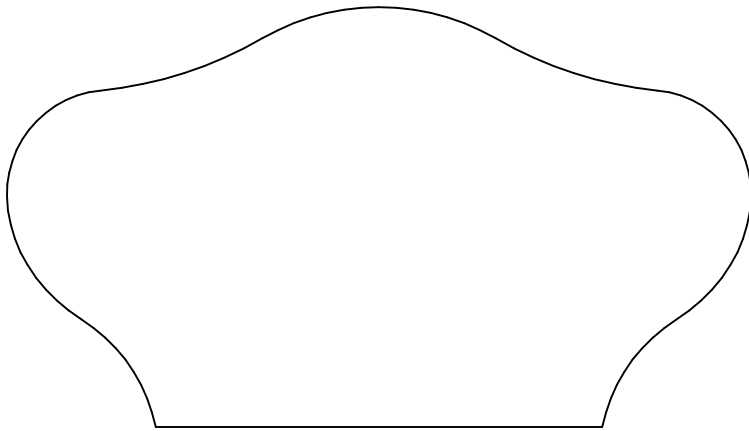

KL 3916
2.187 x 3.875

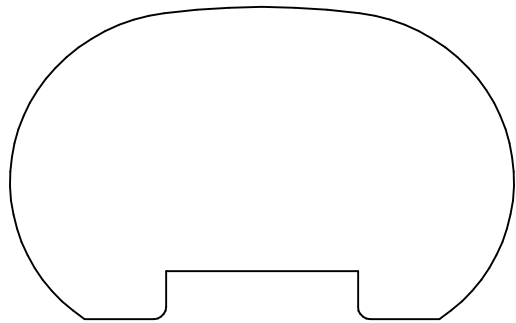

KL 3917P
1.625 x 2.625

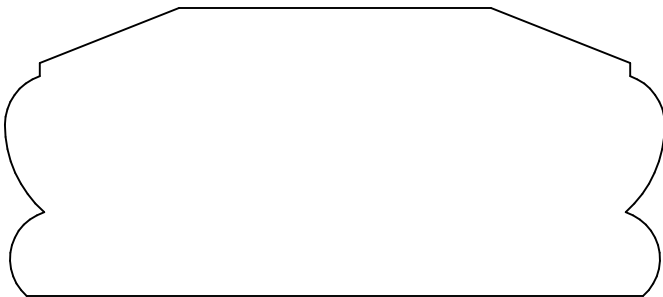

KL 3918
1.500 x 3.437

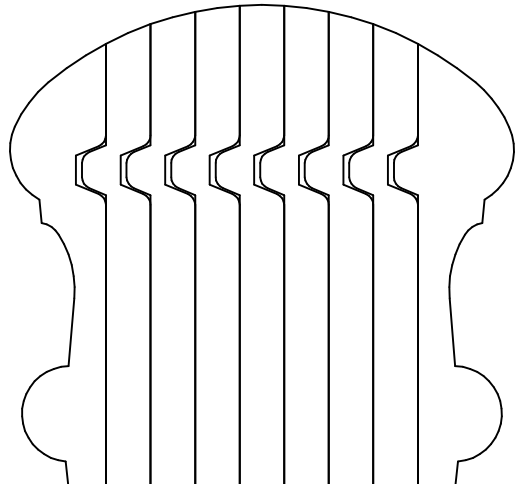

KL 3921B
2.500 x 2.625

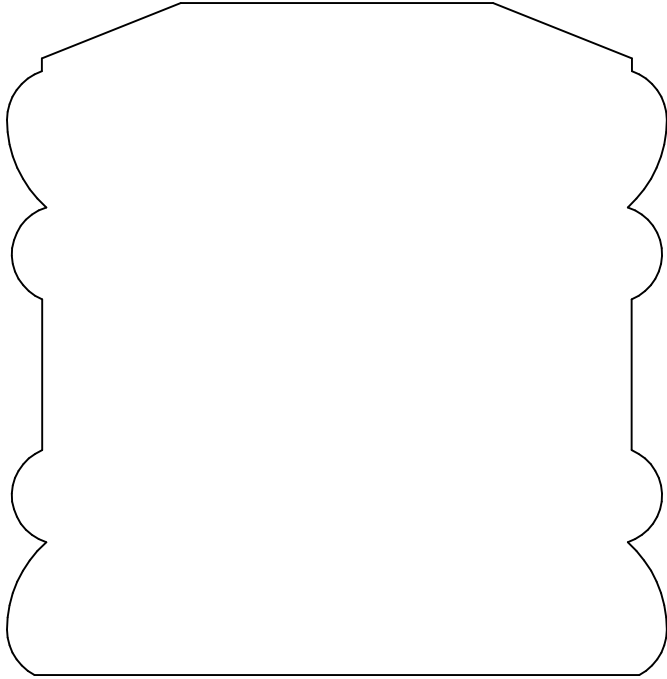

KL 3919
3.500 x 3.437

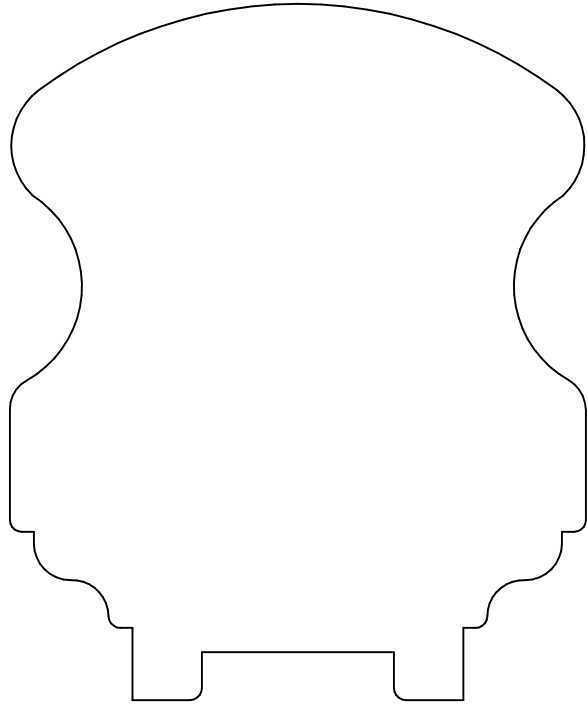

KL 3920P
3.625 x 3.000

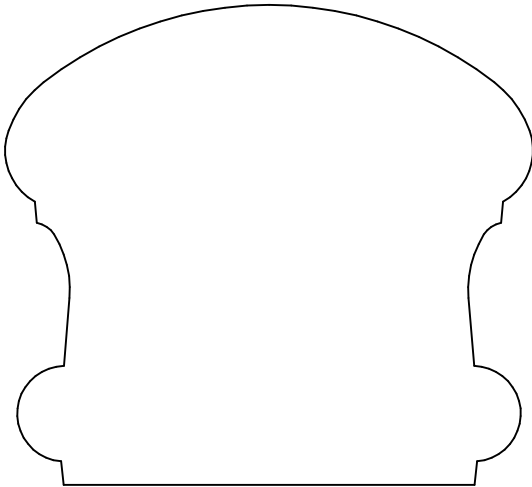

KL 3921
2.500 x 2.750

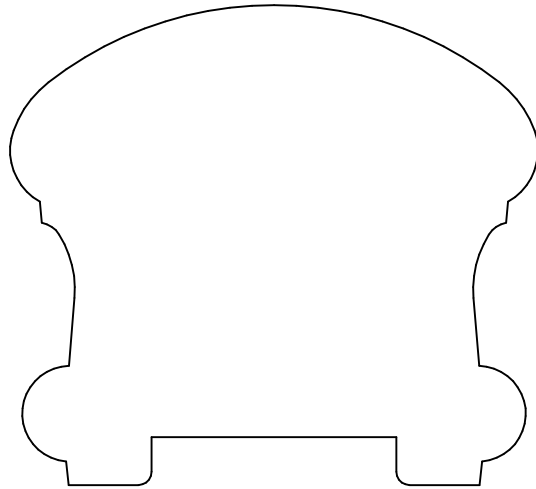

KL 3921P
2.500 x 2.750

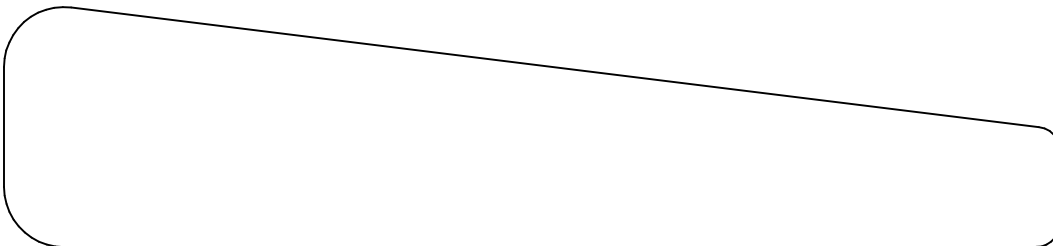

KL 3924
1.250 x 5.500

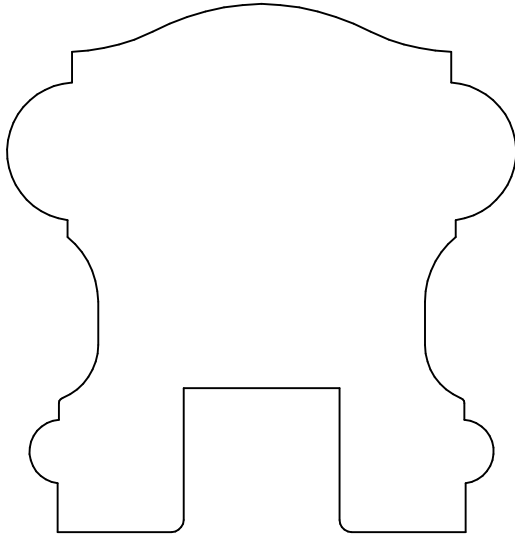

KL3923P
2.750 x 2.651

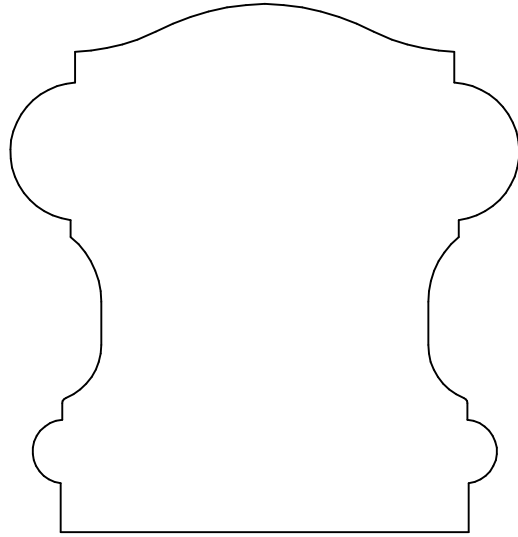

KL 3923
2.750 x 2.651

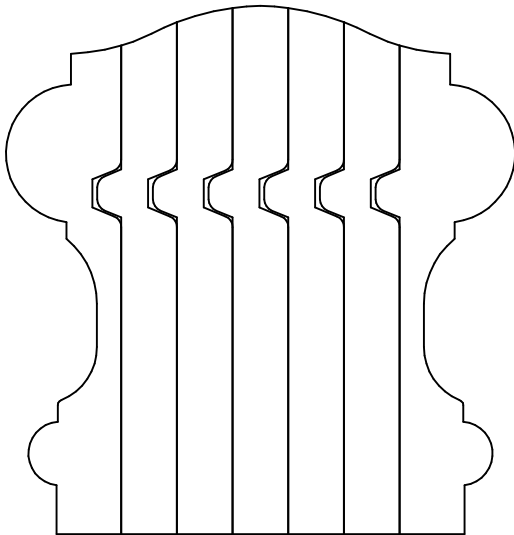

KL 3923B
2.750 x 2.651

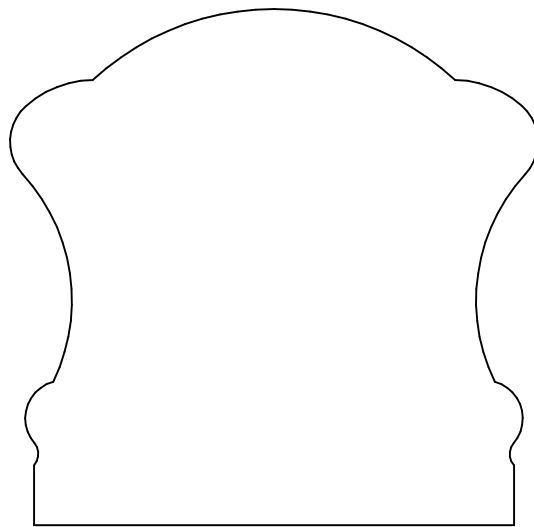

KL 3925
2.688 x 2.750

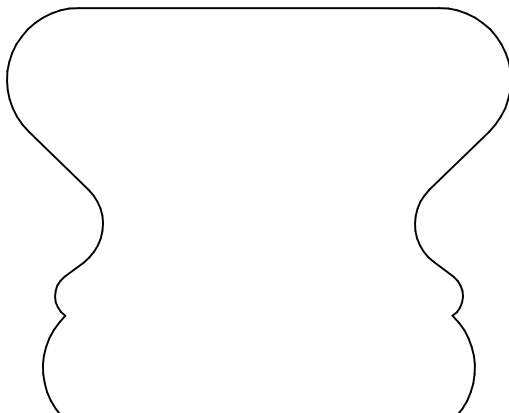

KL 3926
2.125 x 2.625

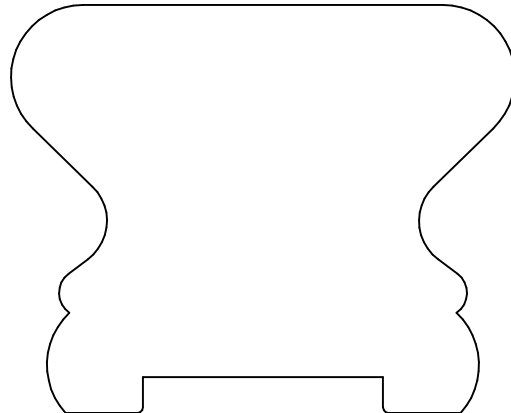

KL 3926P
2.125 x 2.625

CUSTOM PROFILES

Handrail

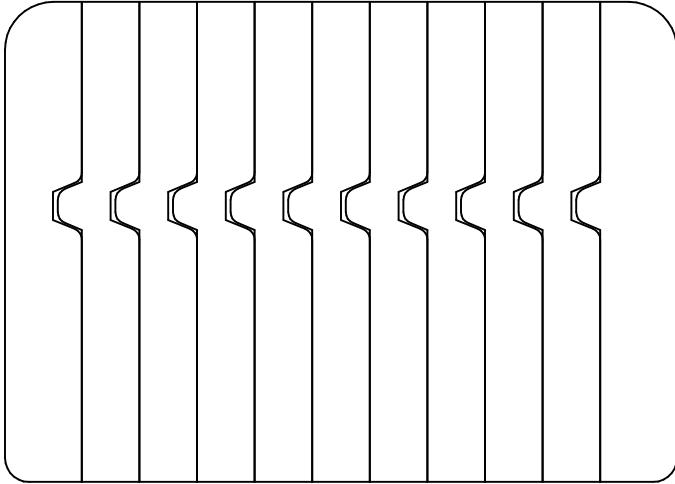

KL 3927B
2.500 x 3.500

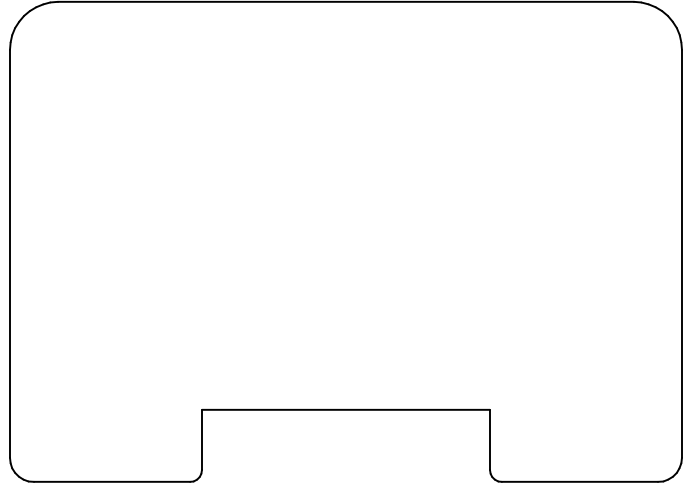

KL 3927P
2.500 x 3.500

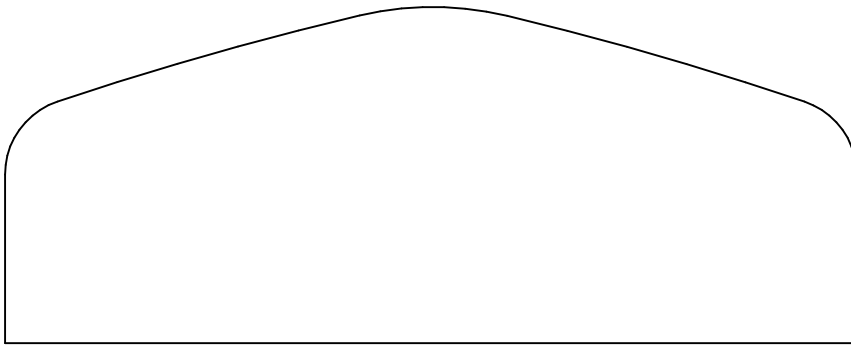

KL 3928
1.750 x 4.437

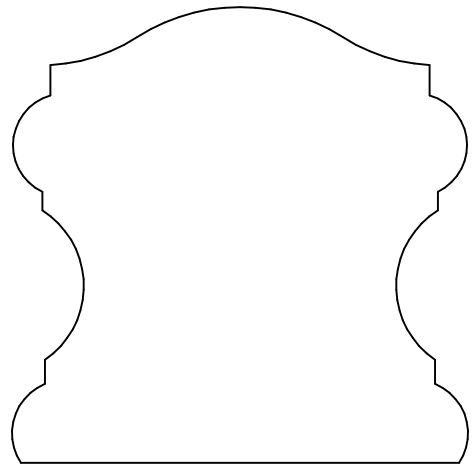

KL 3935
2.375 x 2.375

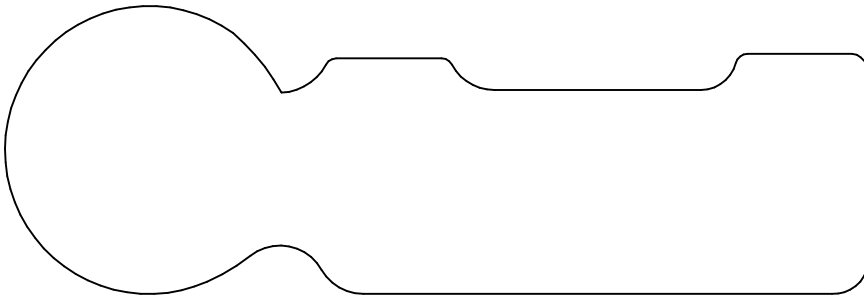

KL 3929
1.500 x 4.500

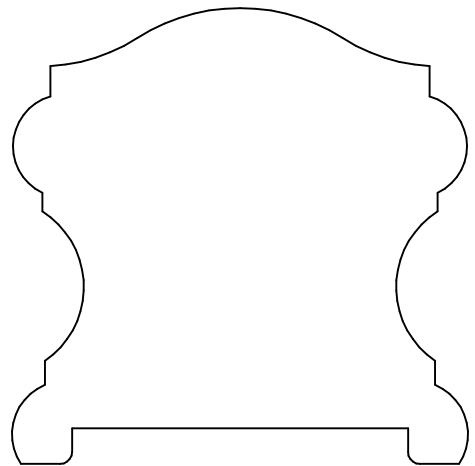

KL 3935 P
2.375 x 2.375

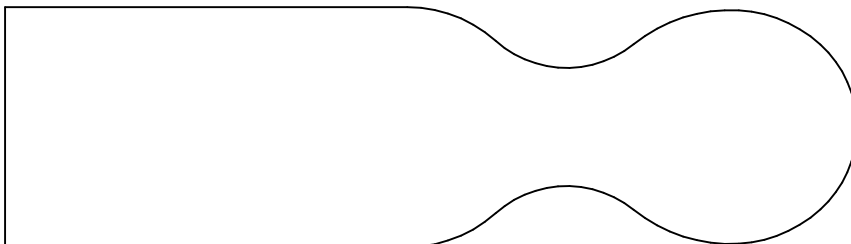

KL 3932
1.250 x 4.437

1-800-362-6682

Keim
BUILT ON TRUST. SINCE 1911

© 2023 Keim

Handrail - 49

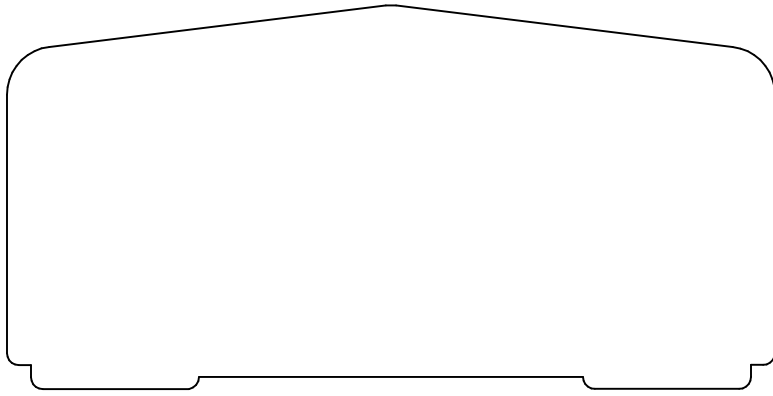

KL 3930
2.000 x 4.000

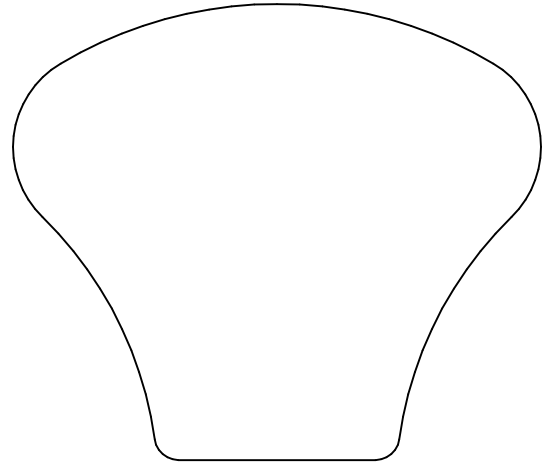

KL 3933
2.375 x 2.750

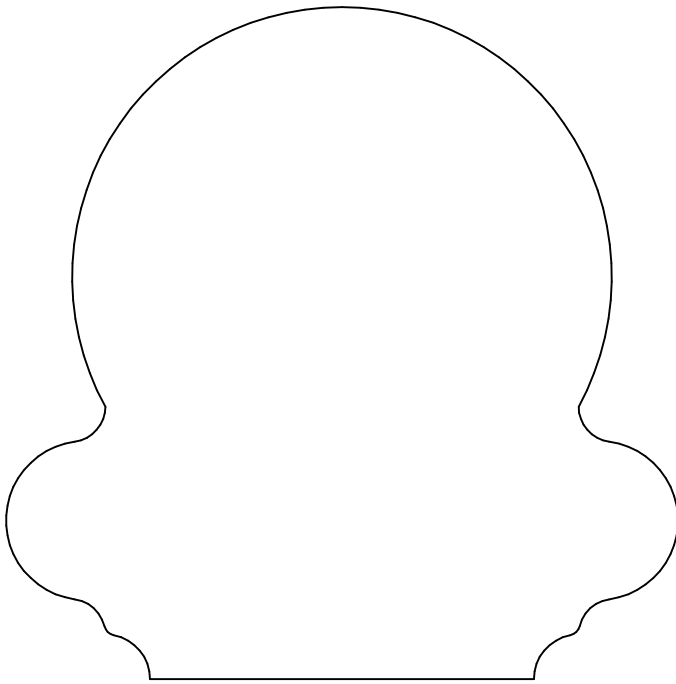

KL 3931
3.500 x 3.500

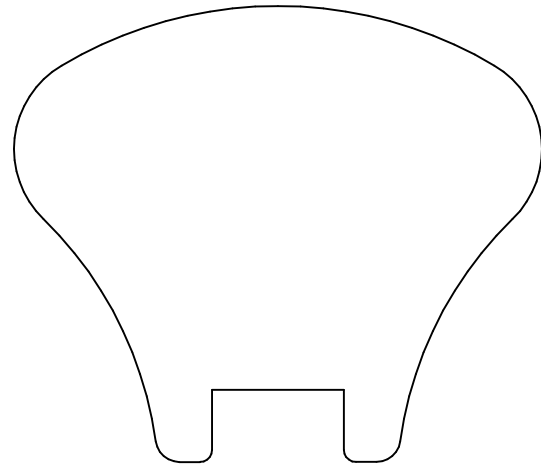

KL 3933P
2.375 x 2.750

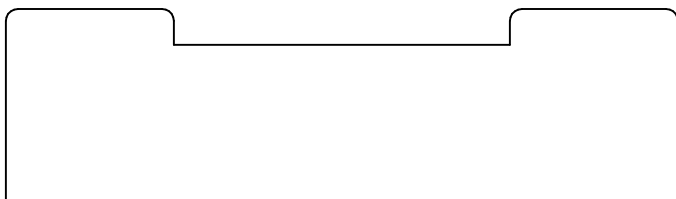

KL 3934P
1.000 x 3.500

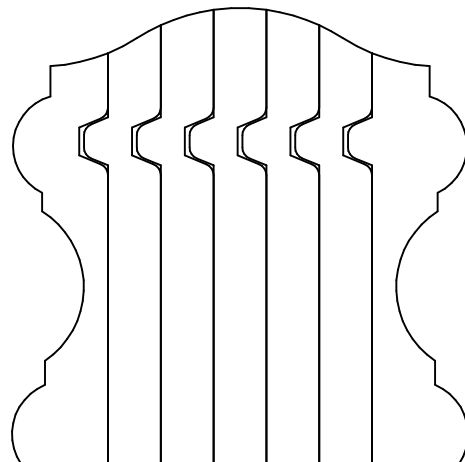

KL 3935B
2.375 x 2.375

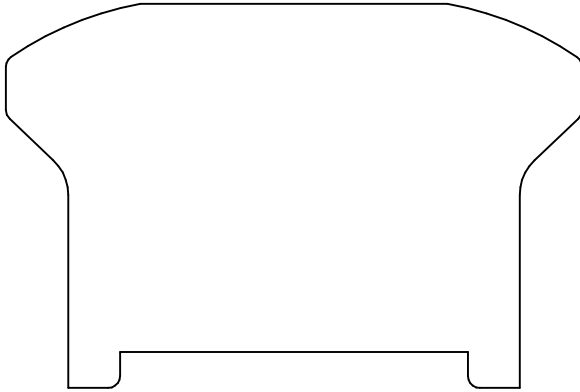

KL 3936P
2.000 x 3.000

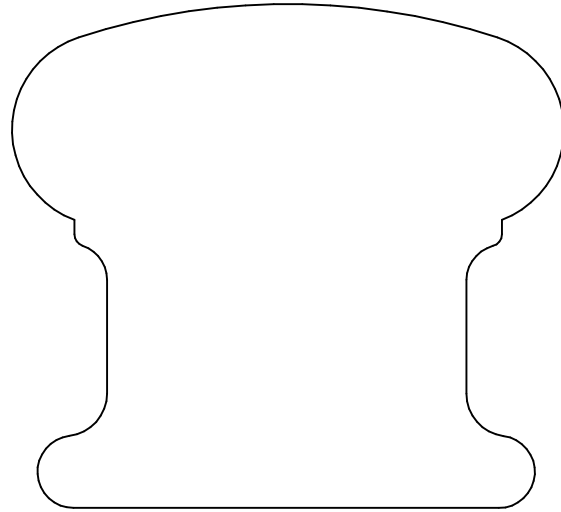

KL 3937
2.625 x 2.875

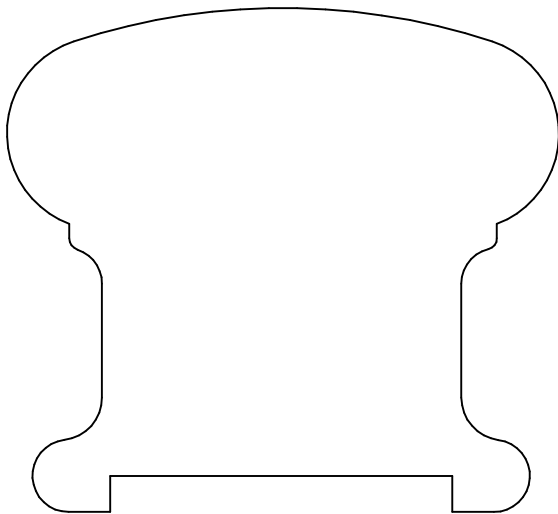

KL 3937P
2.625 x 2.875

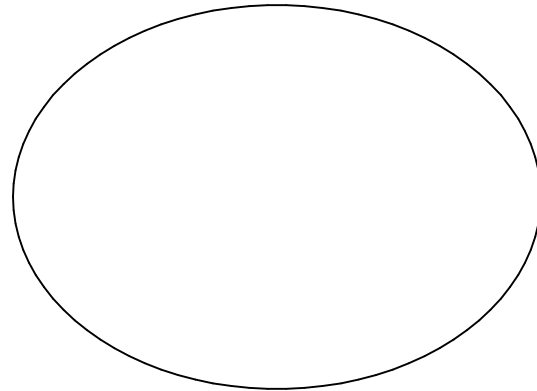

KL 3938
2.000 x 2.750

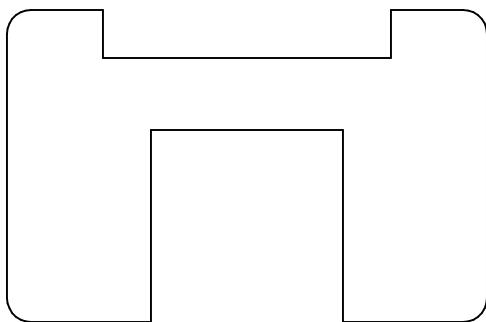

KL 3939P
1.625 x 2.500

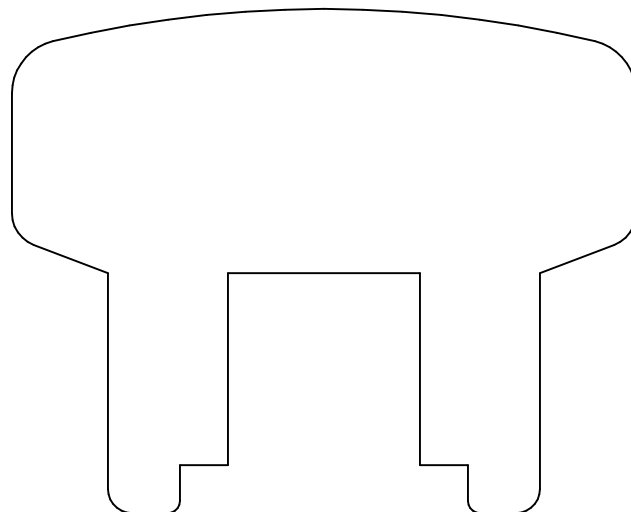

KL 3940P
2.625 x 3.250

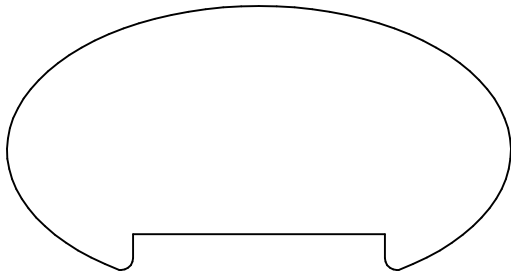

KL 3941P
1.375 x 2.625

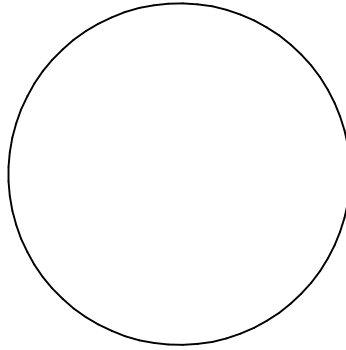

KL 3942
1.78 x 1.78

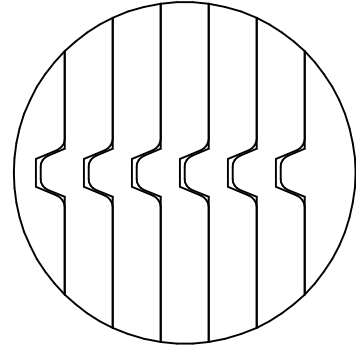

KL 3942B
1.78 x 1.78

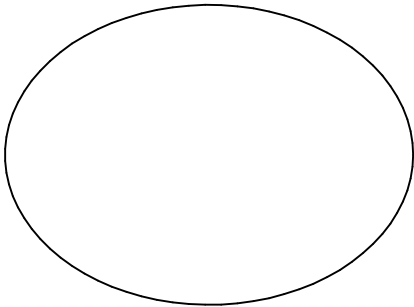

KL 3943
1.562 x 2.125

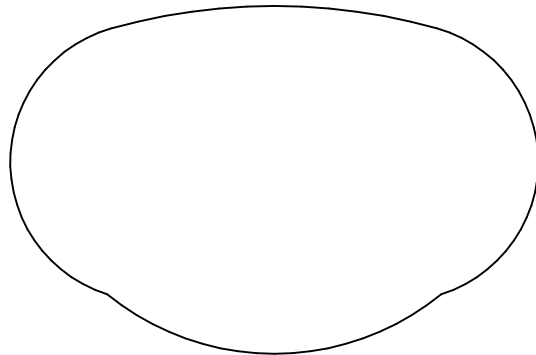

KL 3944
1.812 x 2.750

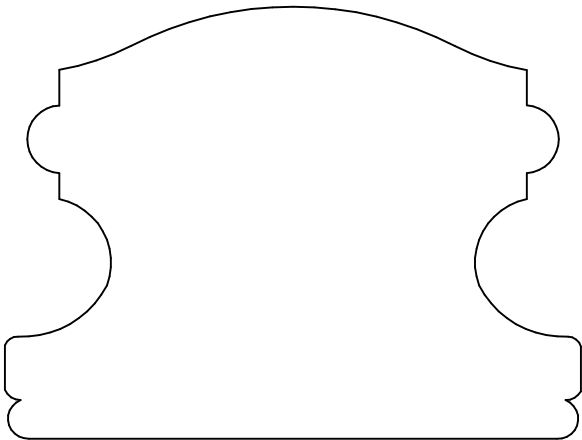

KL 3945
2.250 x 3.000

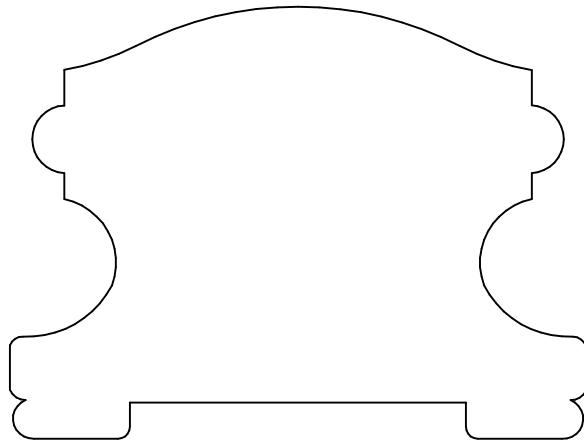

KL 3945P
2.250 x 3.000

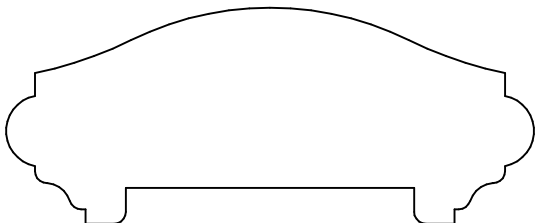

KL 3946P
1.125 x 2.750

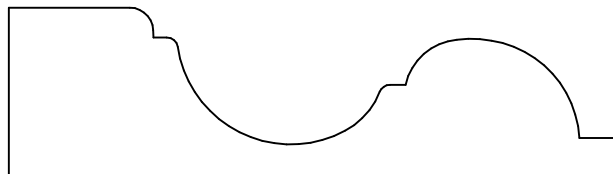

KL 3953
.875 x 3.156

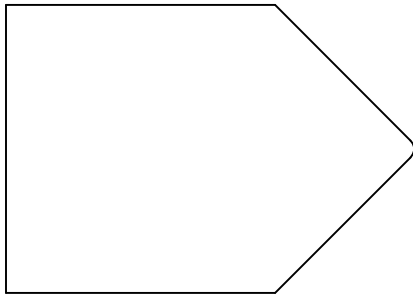

KL 3947
1.500 x 2.125

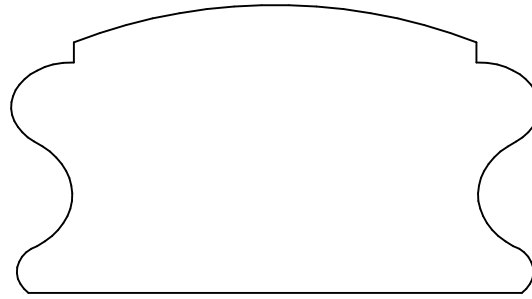

KL 3948
1.500 x 2.750

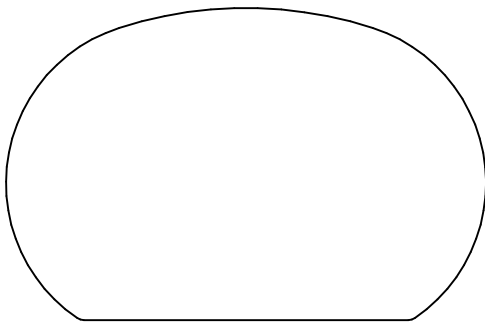

KL 3949
1.625 x 2.500

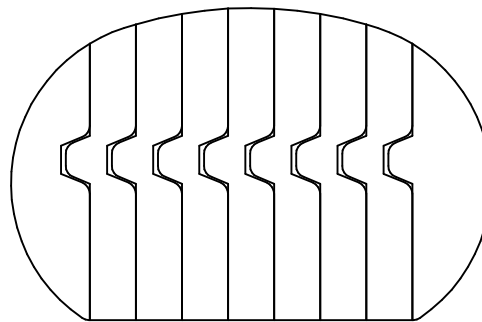

KL 3949B
1.625 x 2.500

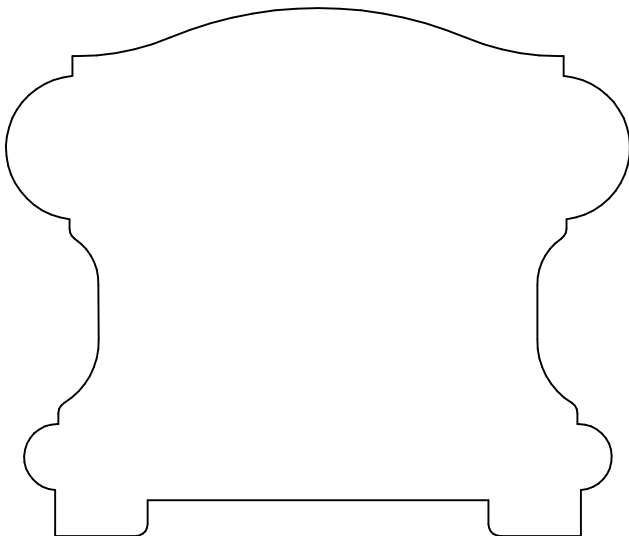

KL 3950P
2.750 x 3.250

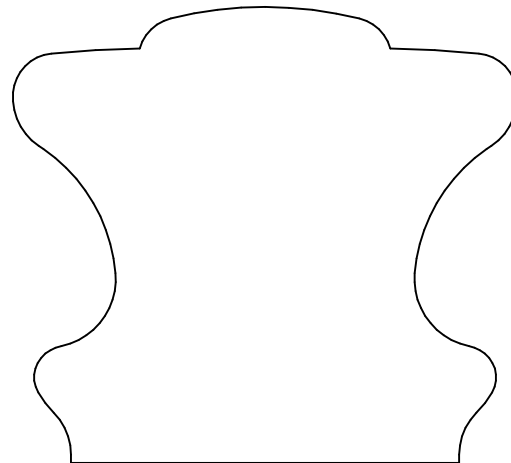

KL 3951
2.375 x 2.625

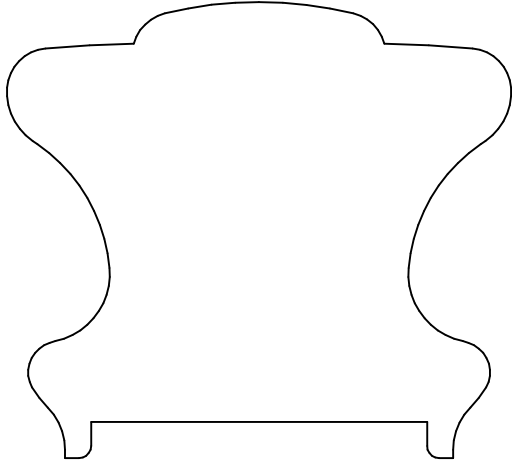

KL 3951P
2.375 x 2.625

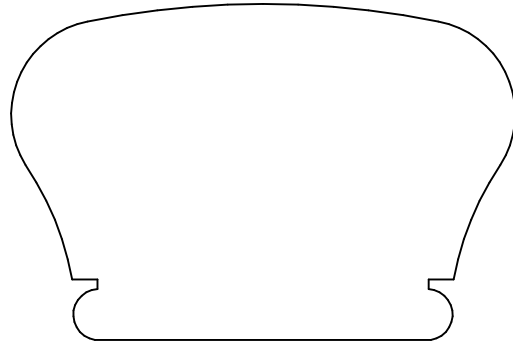

KL 3955
1.750 x 2.625

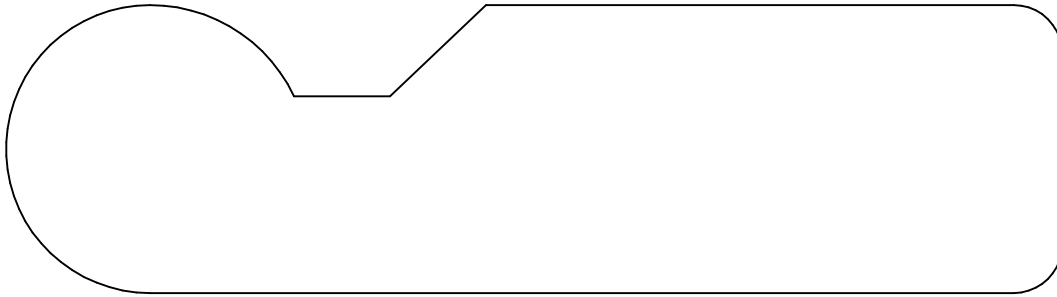

KL 3952
1.500 x 5.500

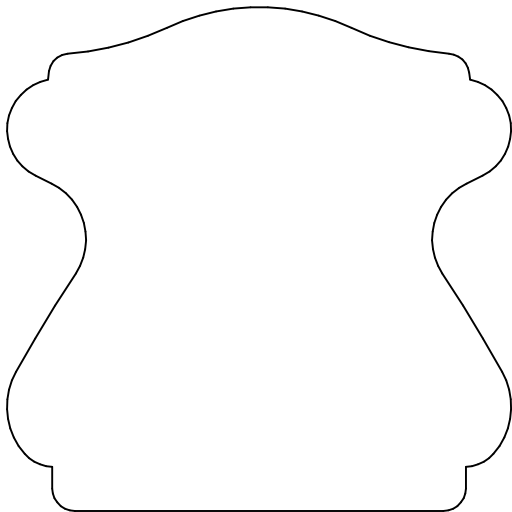

KL 3954
2.625 x 2.625

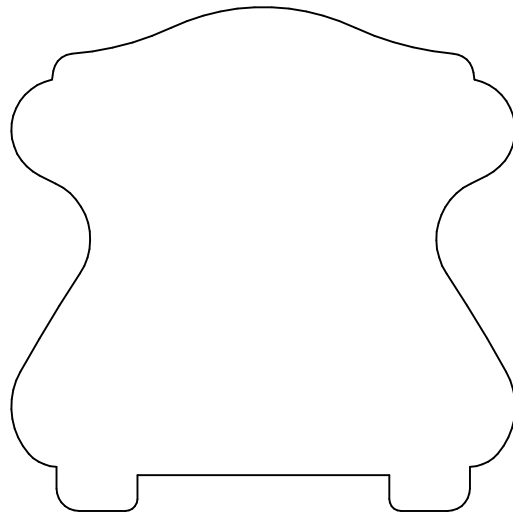

KL 3954P
2.625 x 2.625

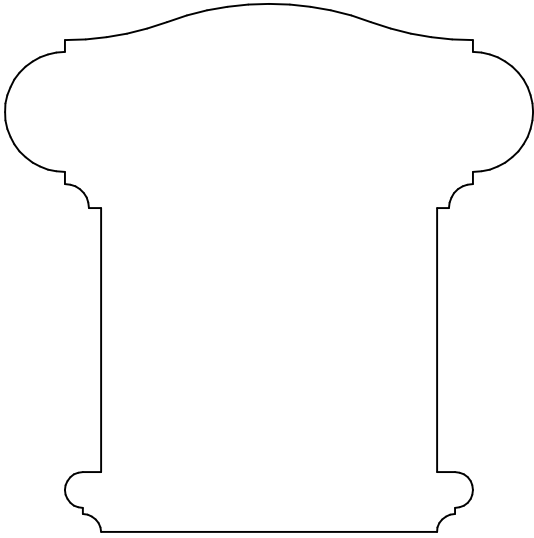

KL 3956
2.750 x 2.750

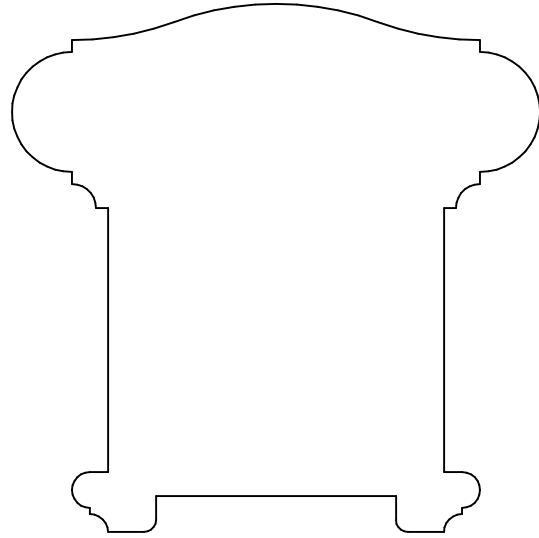

KL 3956P
2.750 x 2.750



KL 3957P
1.375 x 5.375

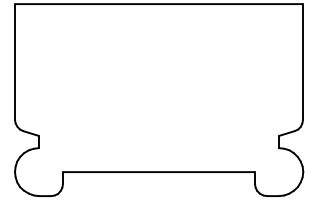

KL 3963P
1.000 x 1.500

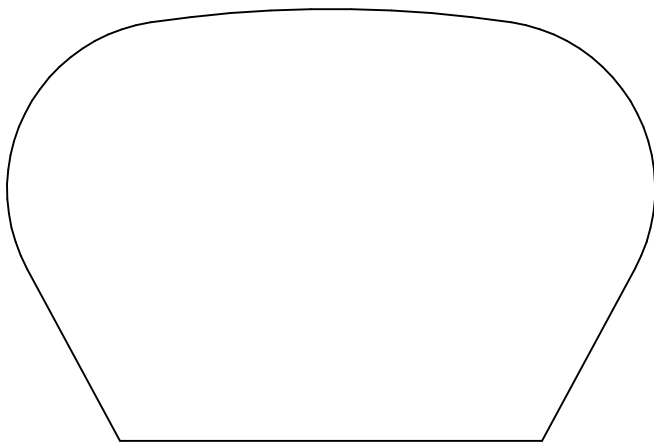

KL 3958
2.250 x 3.375

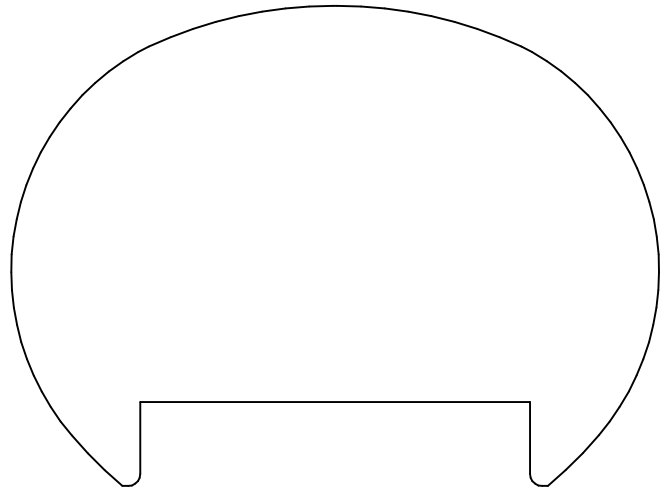

KL 3960P
2.500 x 3.375

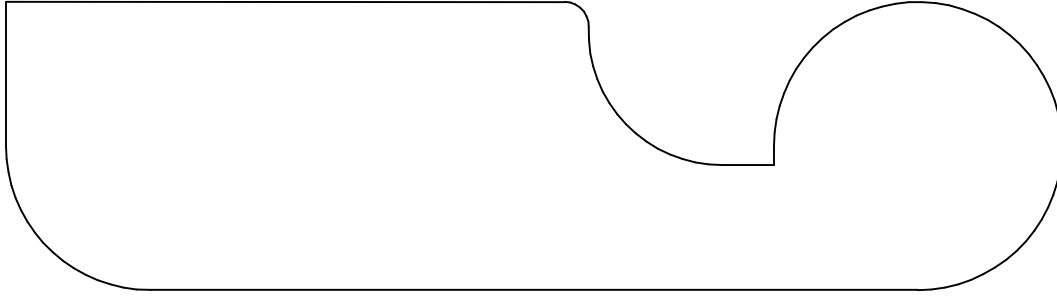

KL 3959
1.500 x 5.500

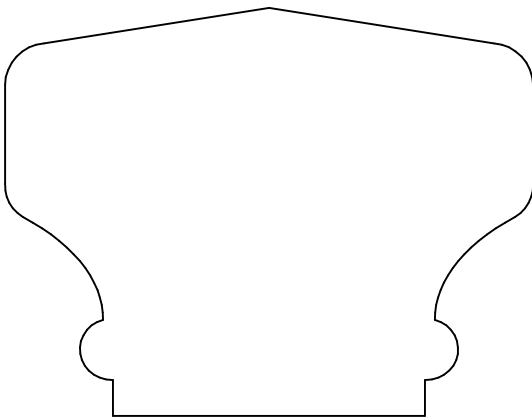

KL 3961
2.125 x 2.750

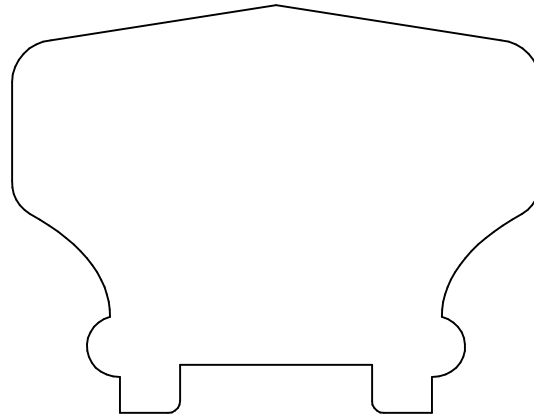

KL 3961P
2.125 x 2.750

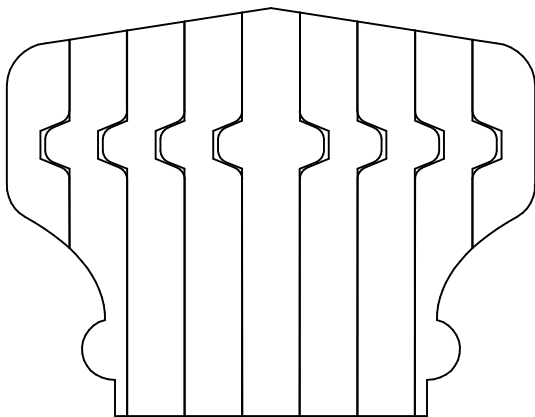

KL 3961B
2.125 x 2.750

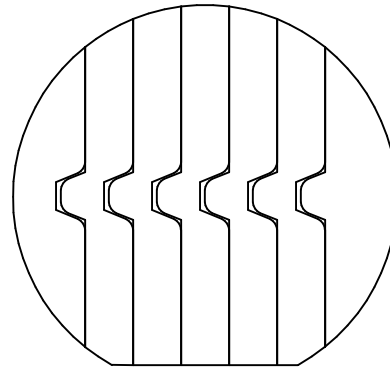

KL 3962B
1.875 x 2.000

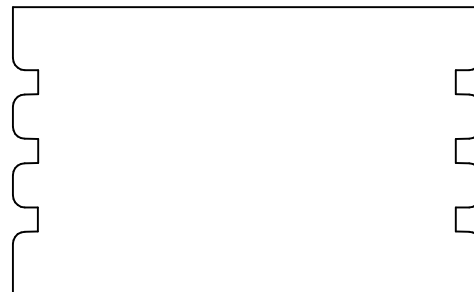

KL 3966
1.500 x 2.437

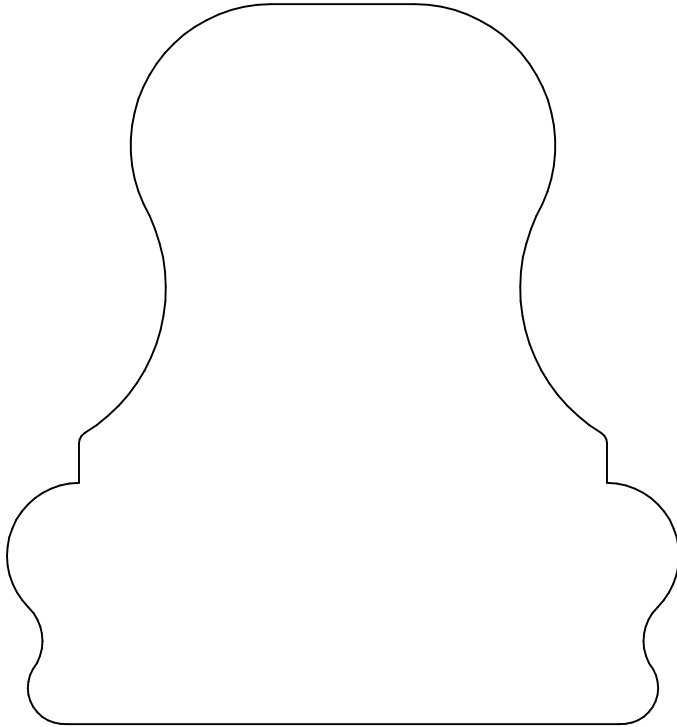

KL 3964
3.750 x 3.500

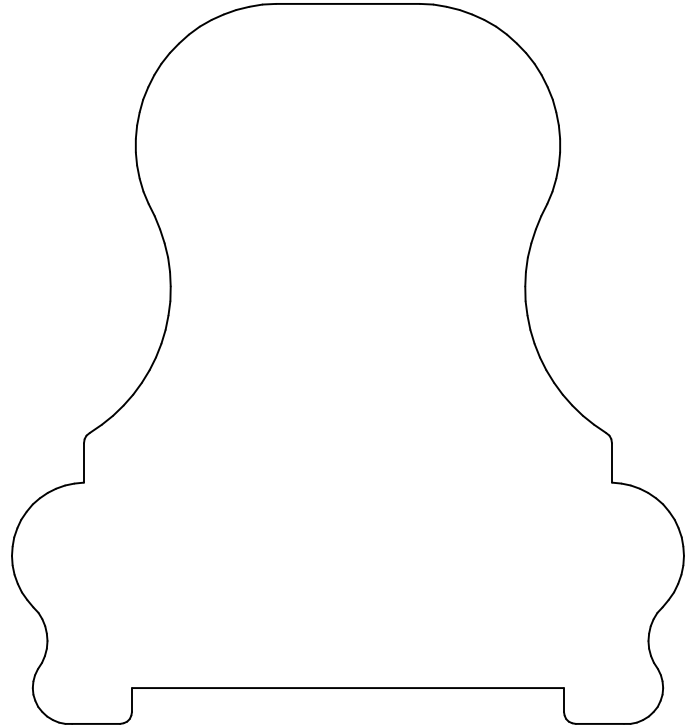

KL 3964P
3.750 x 3.500

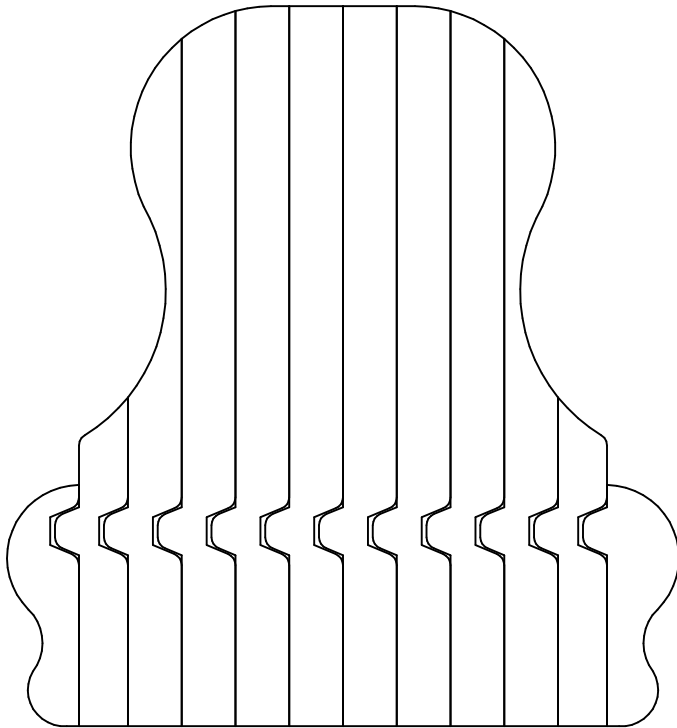

KL 3964B
3.750 x 3.500

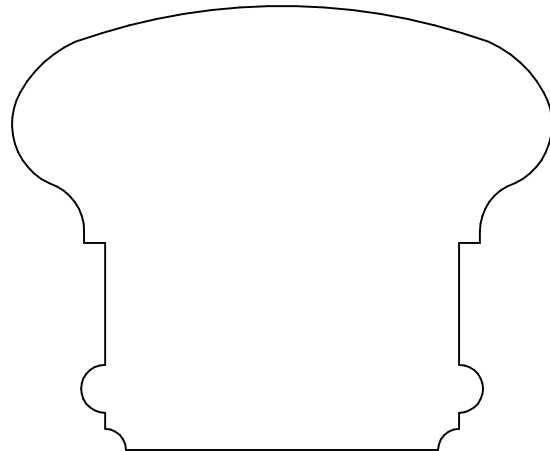

KL 3969
2.312 x 2.813

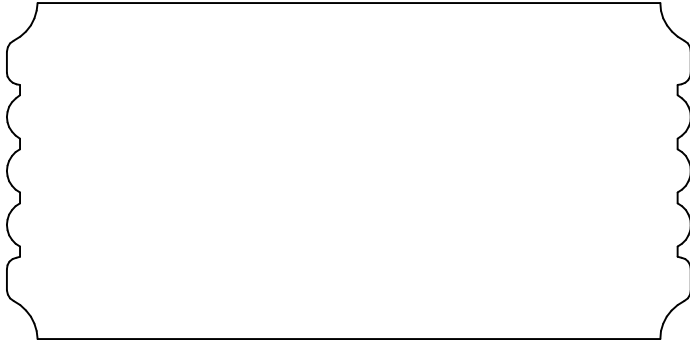

KL 3965
1.750 x 3.562

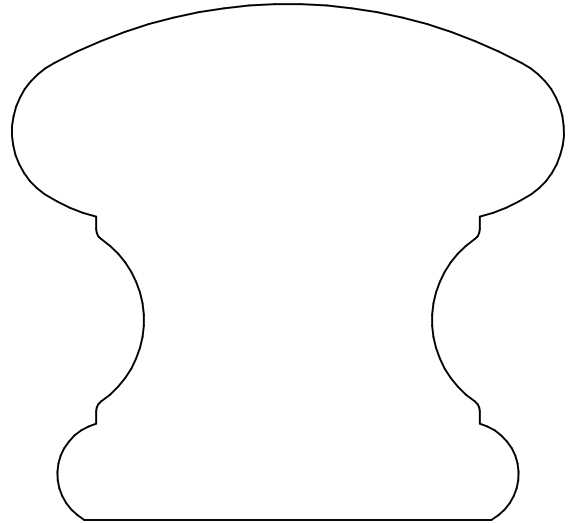

KL 3975
2.687 x 2.875

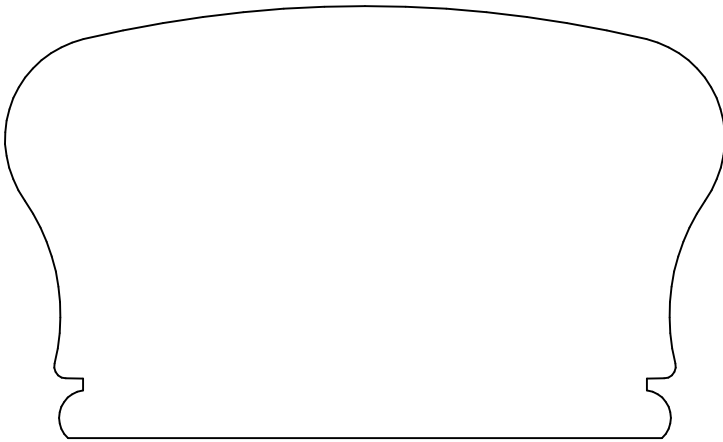

KL 3967
2.250 x 3.750

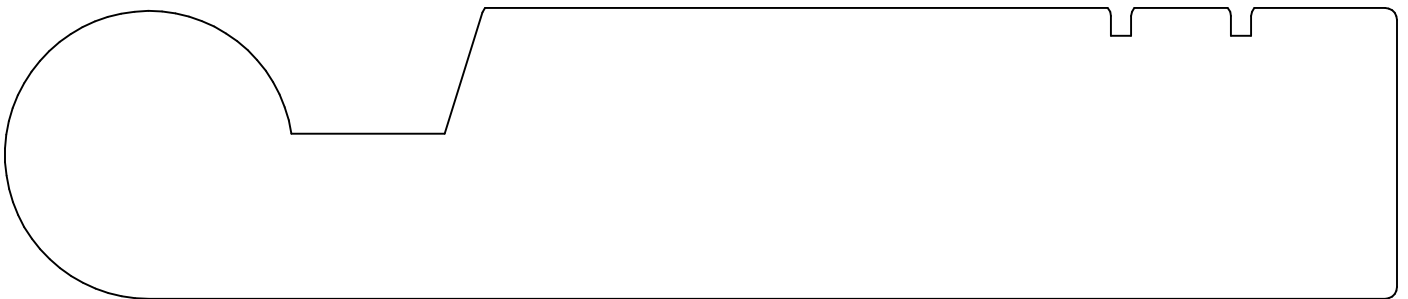

KL 3968
1.515 x 7.250

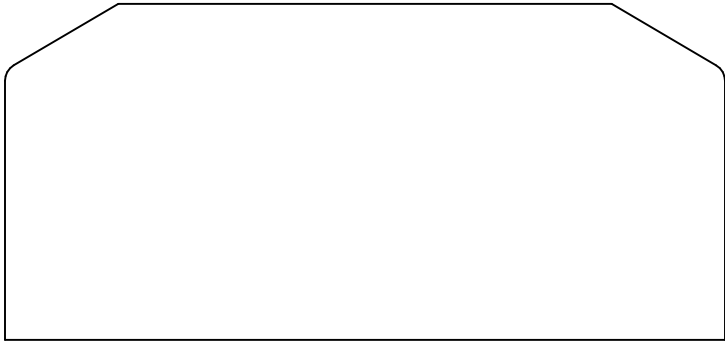

KL 3970
1.750 x 3.750

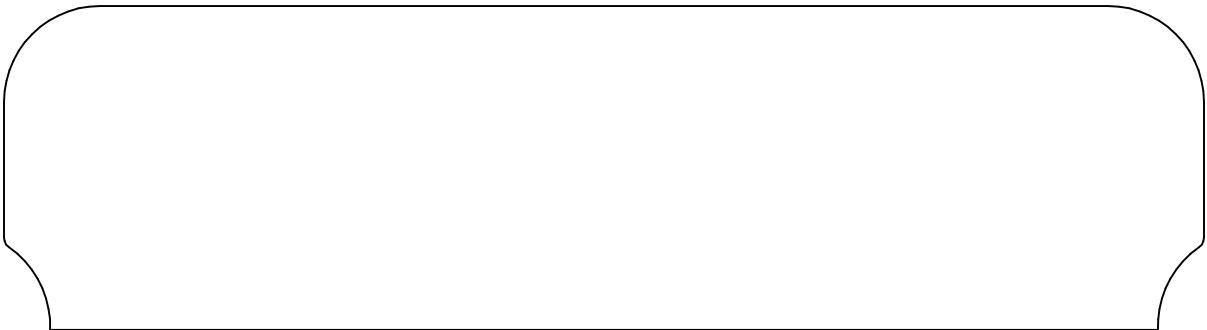

KL 3972
1.687 x 6.250

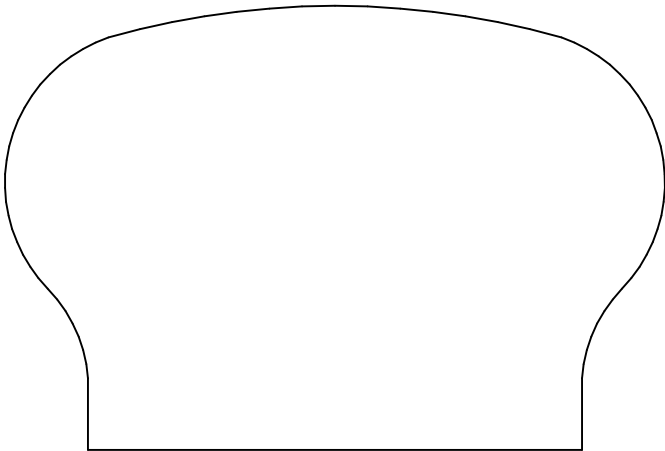

KL 3973
2.312 x 3.437

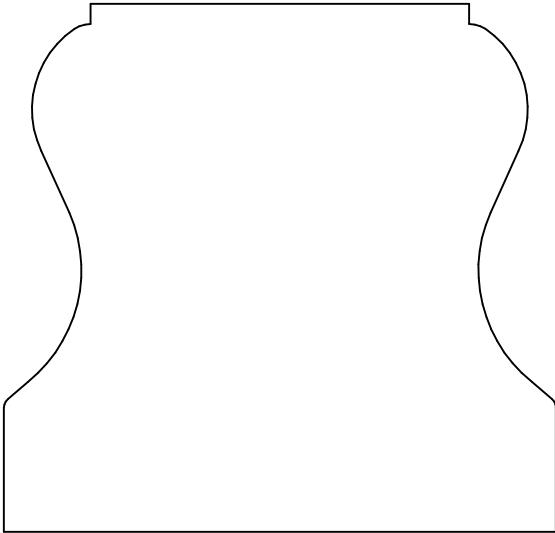

KL 3976
2.750 x 2.875

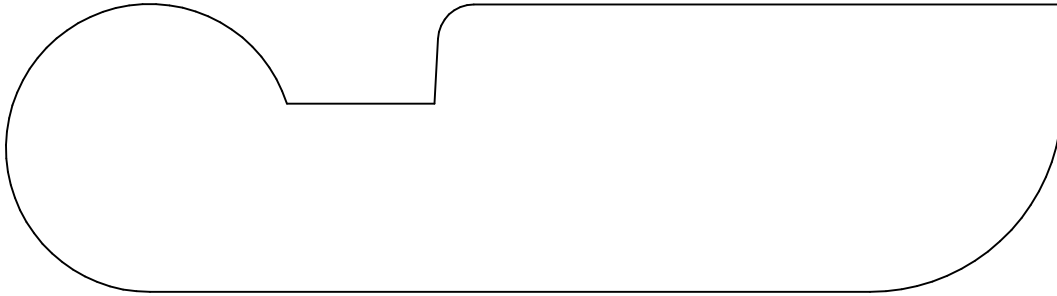

KL 3974
1.500 x 5.500

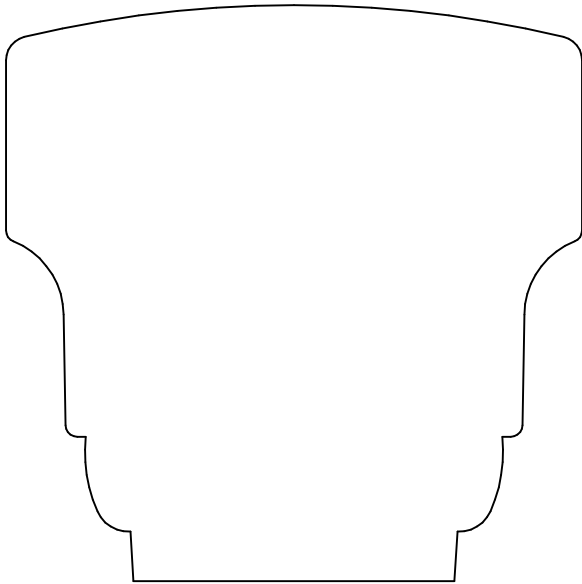

KL 3977
3.000 x 3.000

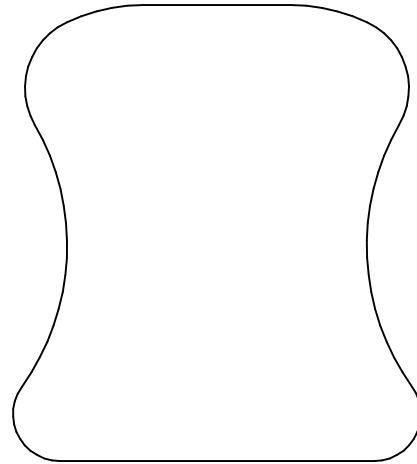

KL 3978
2.375 x 2.125

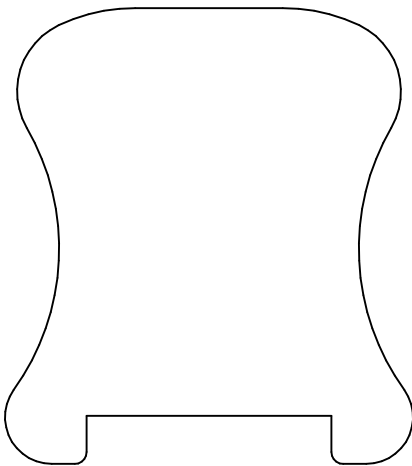

KL 3978P
2.375 x 2.125

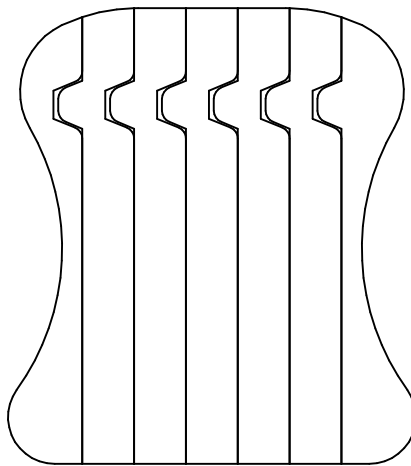

KL 3978B
2.375 x 2.125

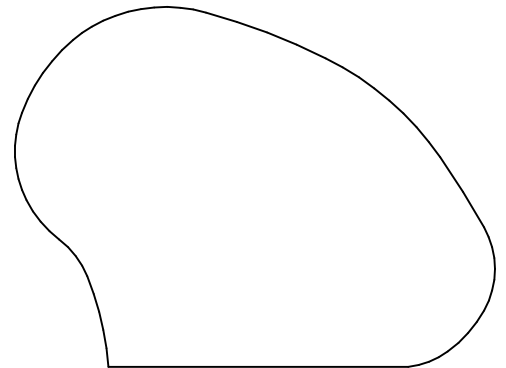

KL 3984
1.875 x 2.500

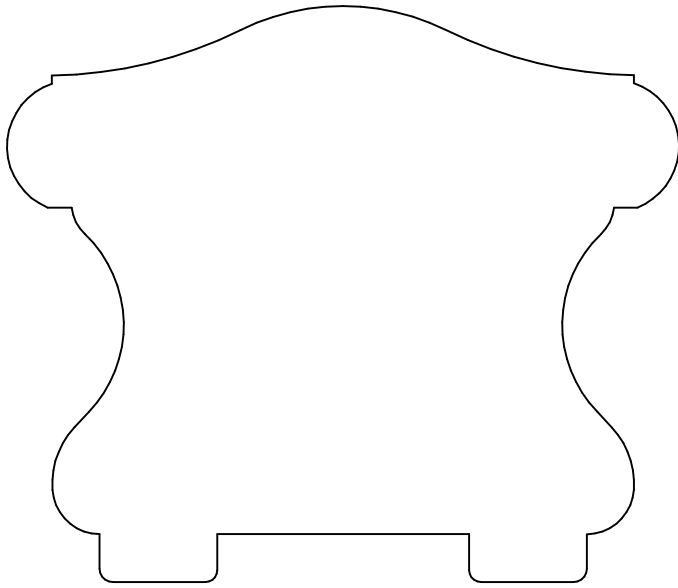

KL 3979P
3.000 x 3.500

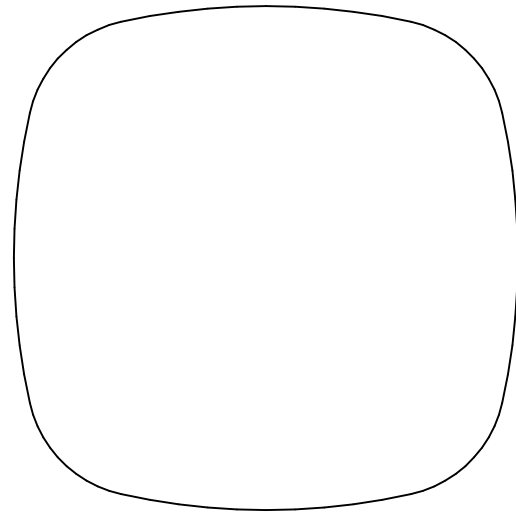

KL 3981
2.625 x 2.625

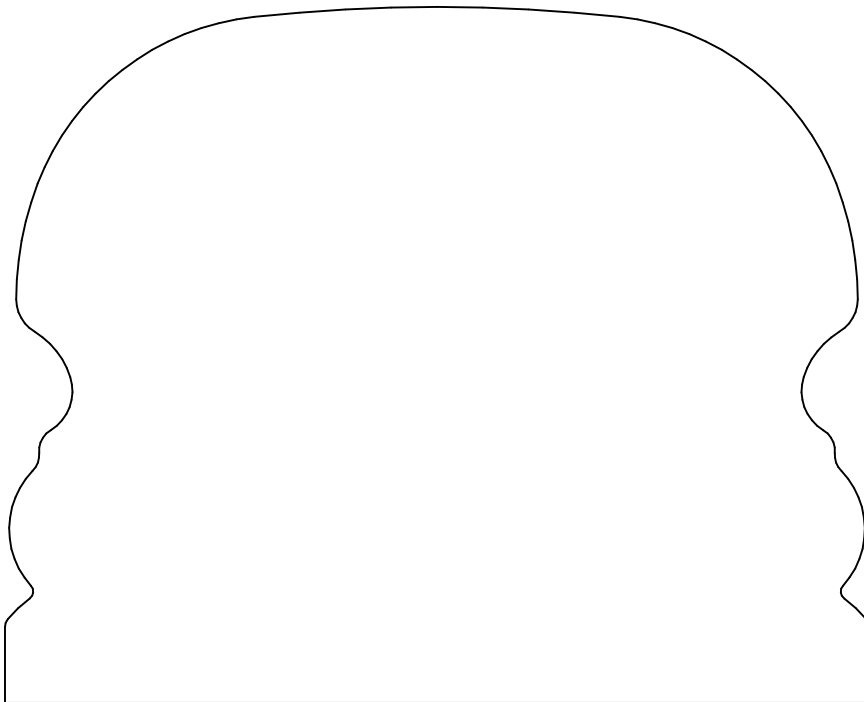

KL 3980
3.625 x 4.500

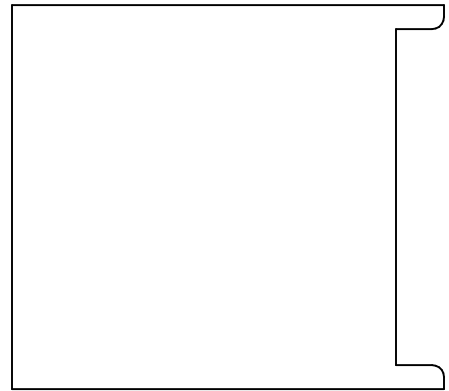

KL 3993P
2.000 x 2.250



KL 3996
.875 x 2.250

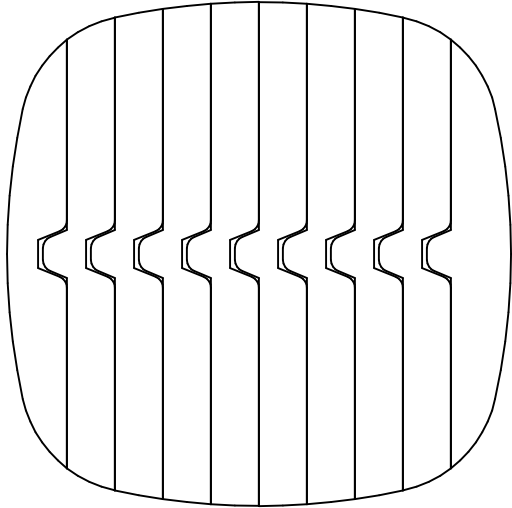

KL 3981B
2.625 x 2.625

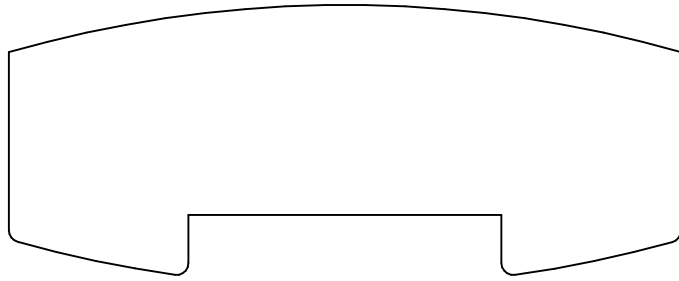

KL 3982P
1.406 x 3.500

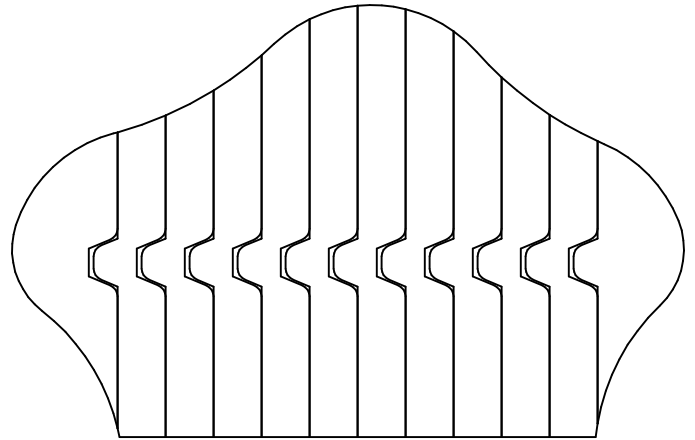

KL 3983B
2.250 x 3.500

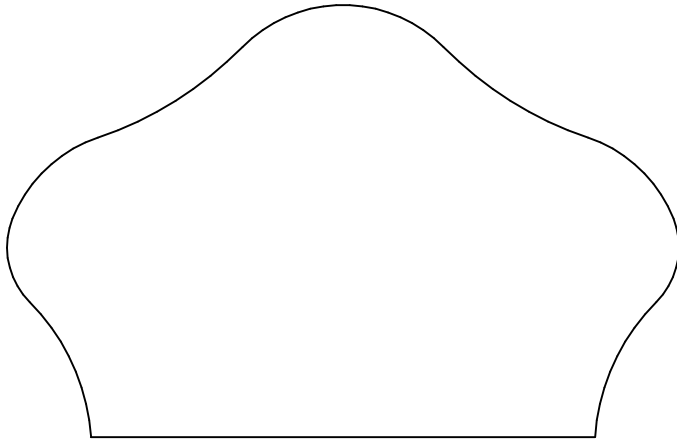

KL 3983
2.250 x 3.500

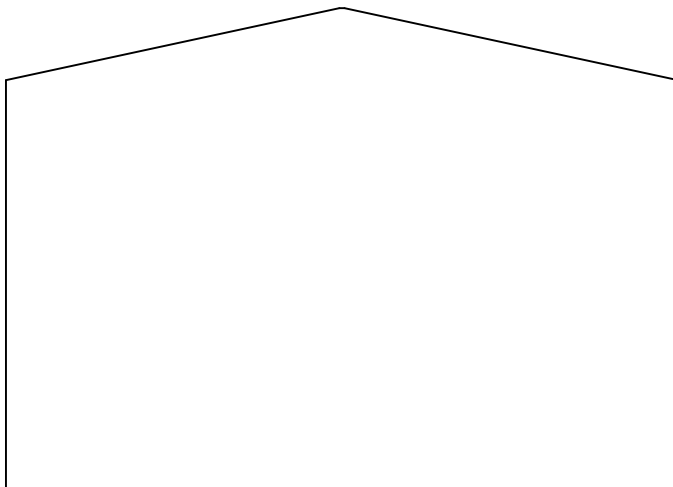

KL 3986
2.500 x 3.500

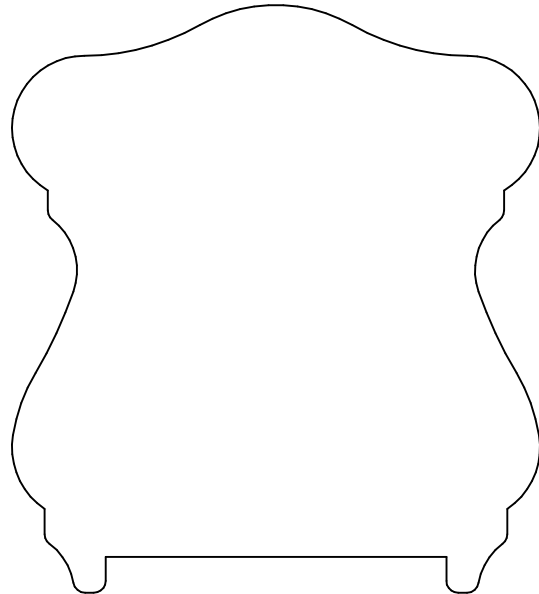

KL 3985P
3.062 x 2.750

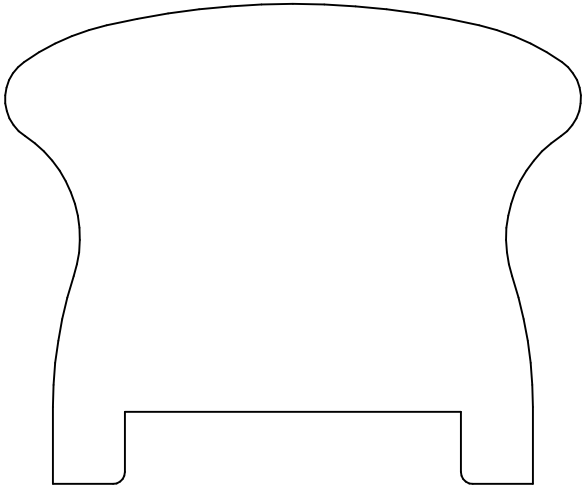

KL 3988P
2.500 x 3.000

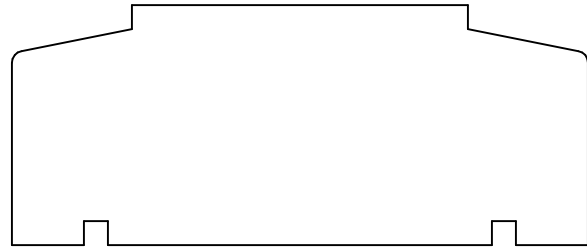

KL 3989
1.250 x 3.000

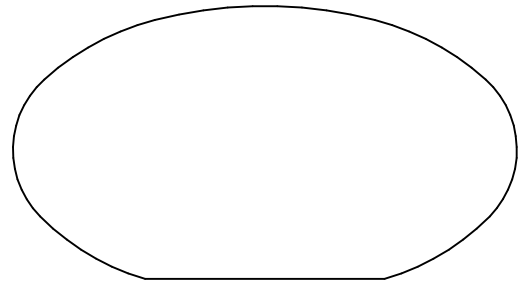

KL 3991
1.421 x 2.625

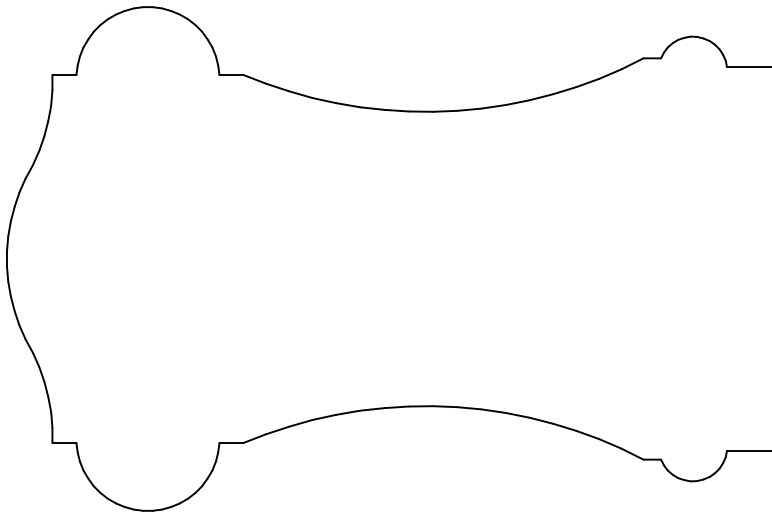

KL 3990
4.000 x 2.625

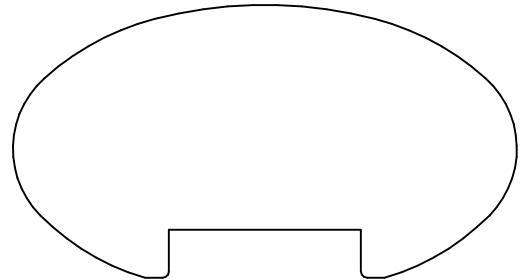

KL 3991P
1.421 x 2.625



KL 3992P
2.000 x 4.500

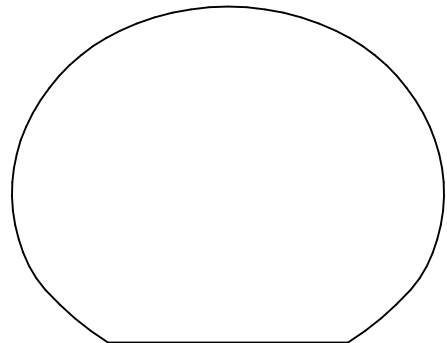

KL 3999
1.750 x 2.250

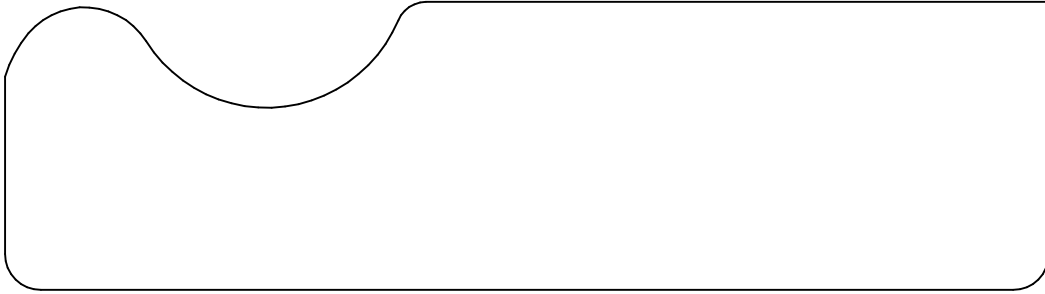

KL 3994
1.500 x 5.437

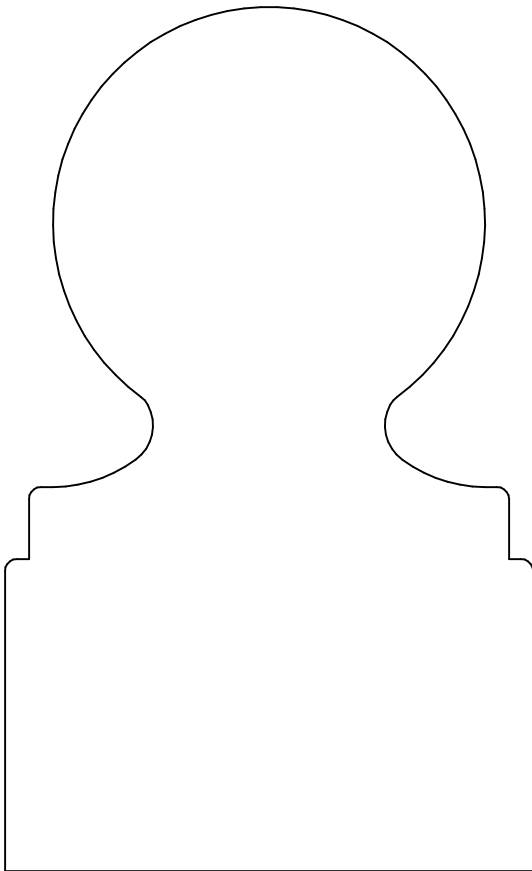

KL 3995
4.500 x 2.750

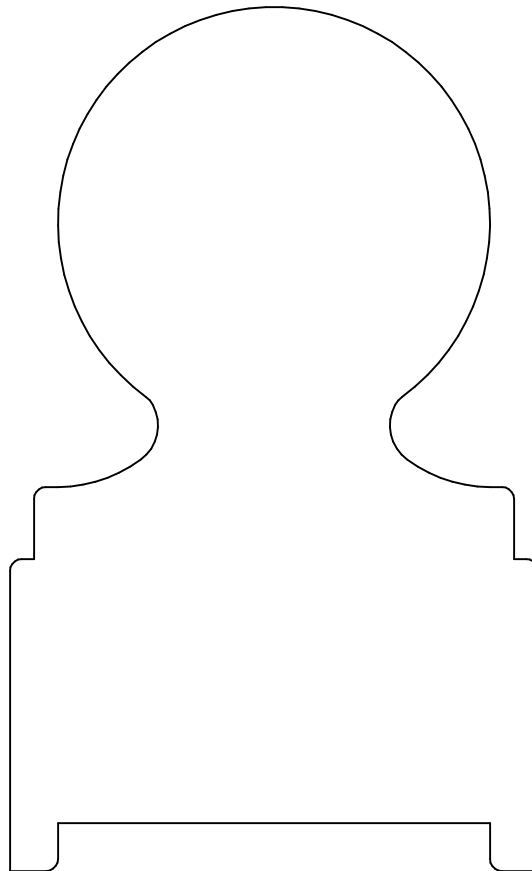

KL 3995P
4.500 x 2.750

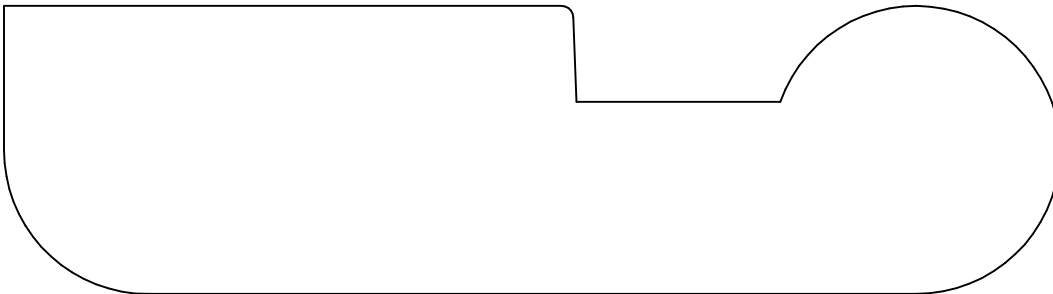

KL 3997
1.500 x 5.500

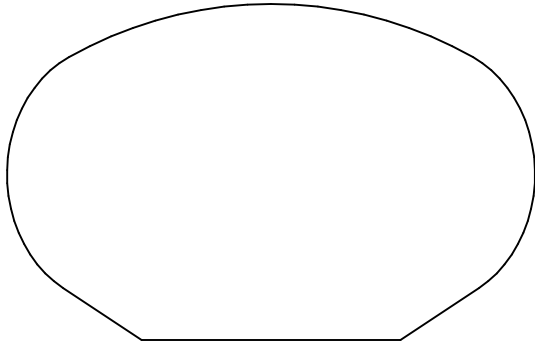

KL 3998
1.750 x 2.750

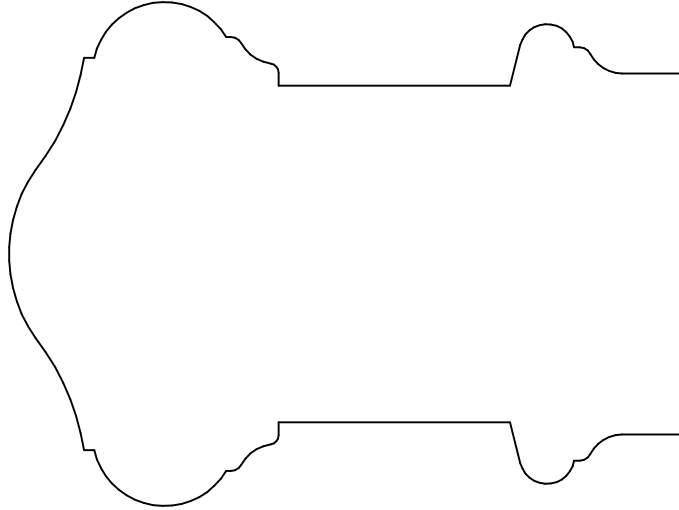

KL 4900
3.500 x 2.625

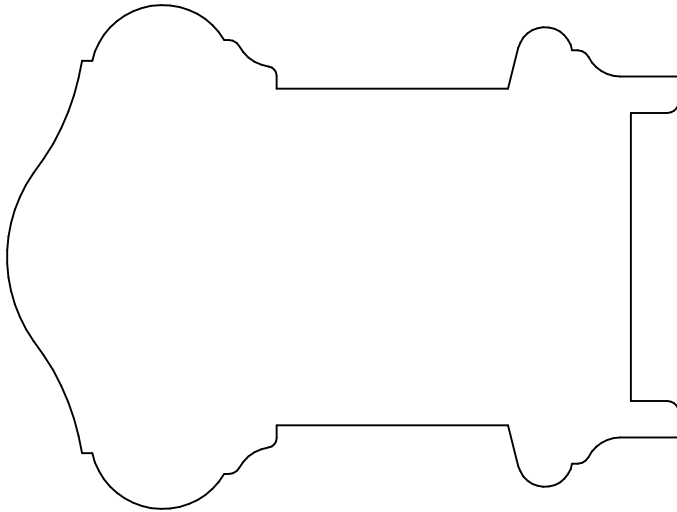

KL 4900P
3.500 x 2.625

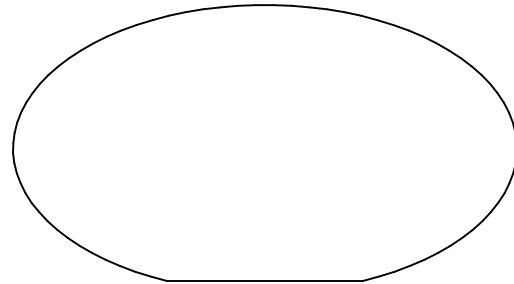

KL 4902
1.437 x 2.625

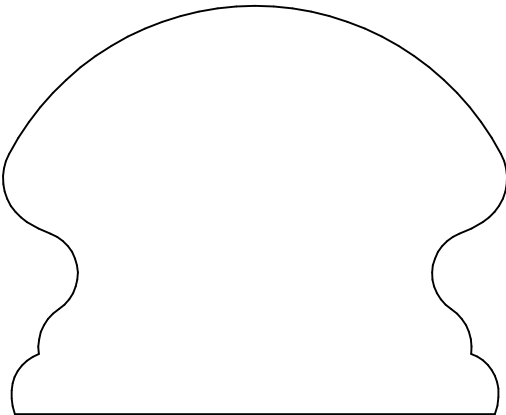

KL 4907
2.125 x 2.625

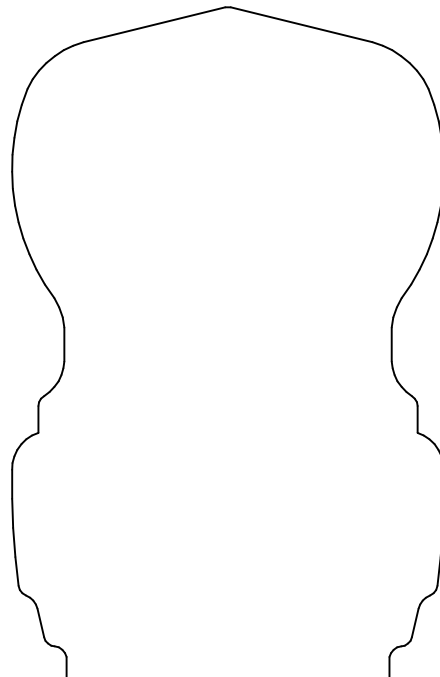

KL 4903
3.500 x 2.250

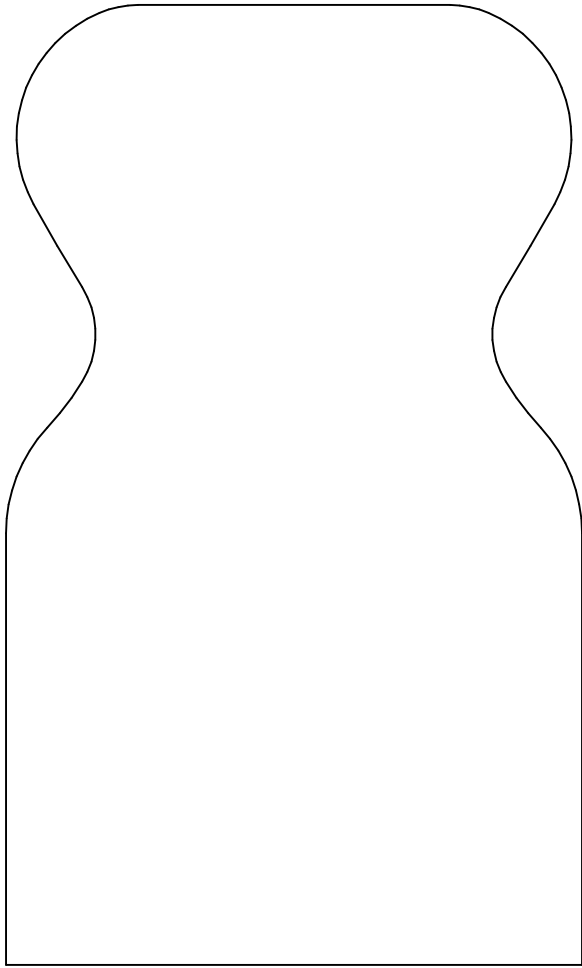

KL 4901
5.000 x 3.000

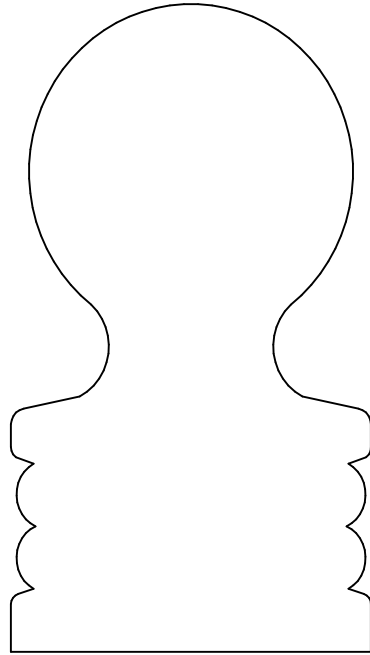

KL 4904
3.375 x 1.875

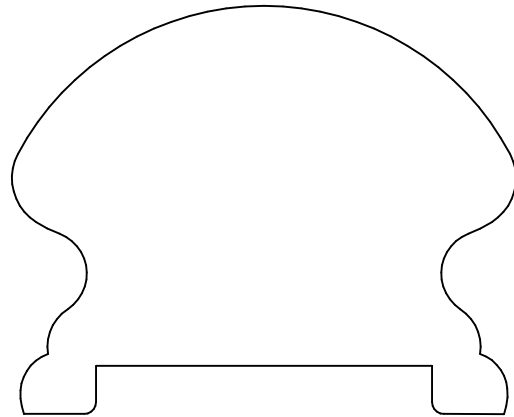

KL 4907P
2.125 x 2.625

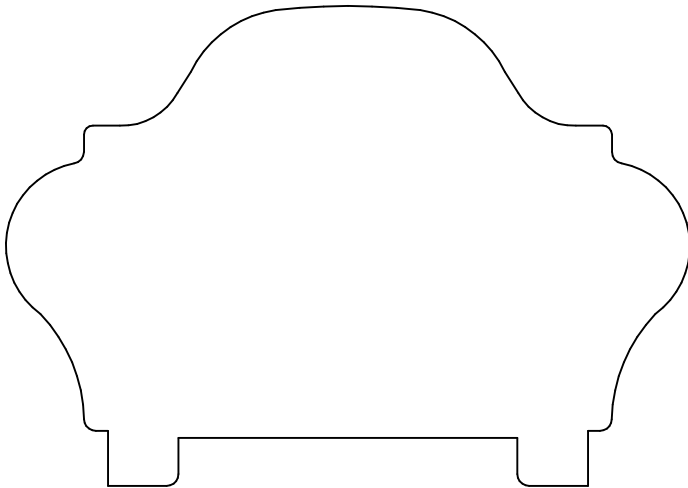

KL 4905P
2.500 x 3.563

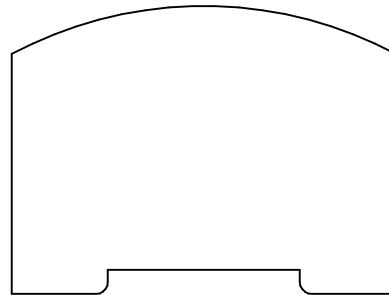

KL 4911P
1.500 x 2.000

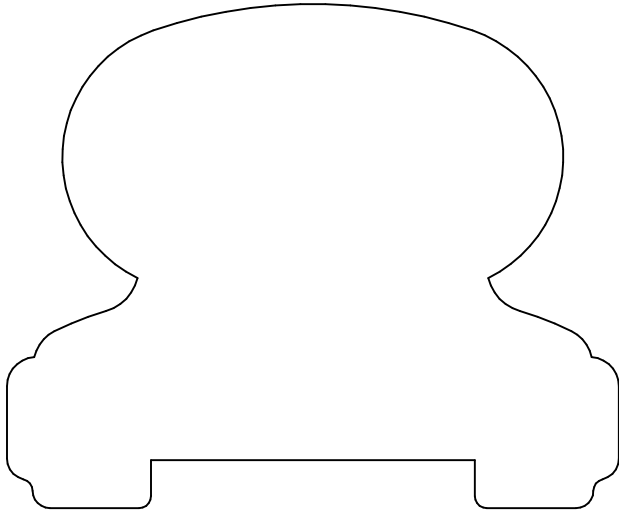

KL 4906P
2.625 x 3.187

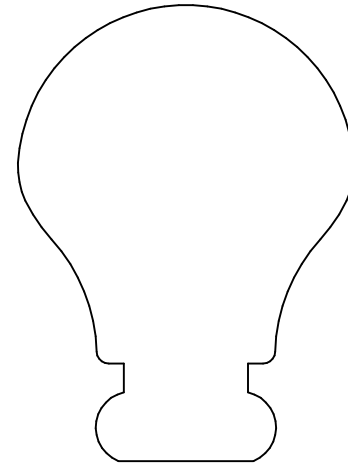

KL 4908
2.375 x 1.750

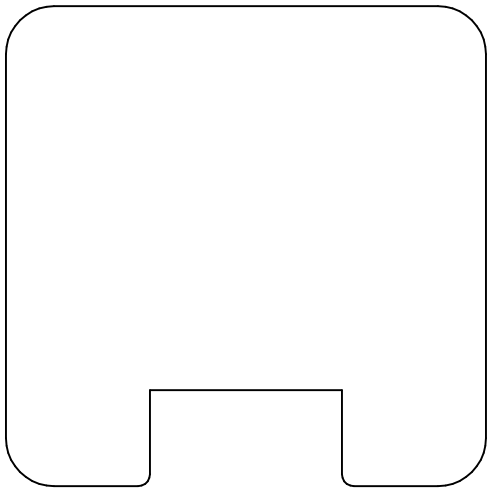

KL 4909P
2.500 x 2.500

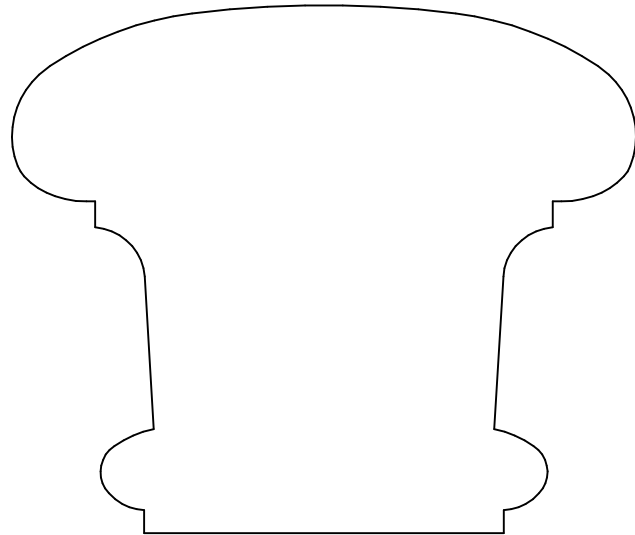

KL 4910
2.750 x 3.250

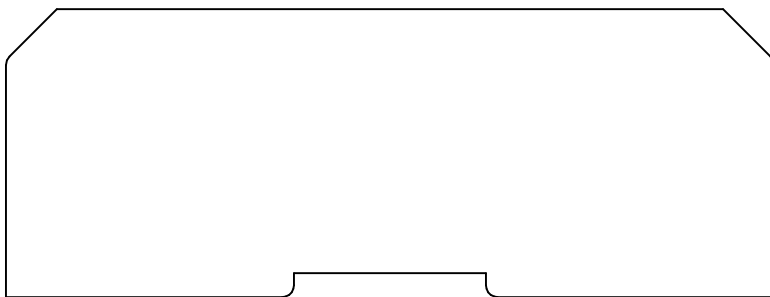

KL 4916P
1.500 x 4.000

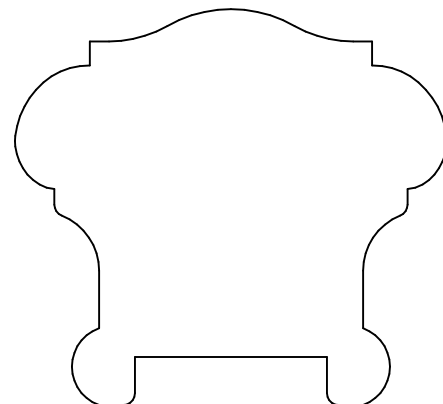

KL 4918P
2.062 x 2.250

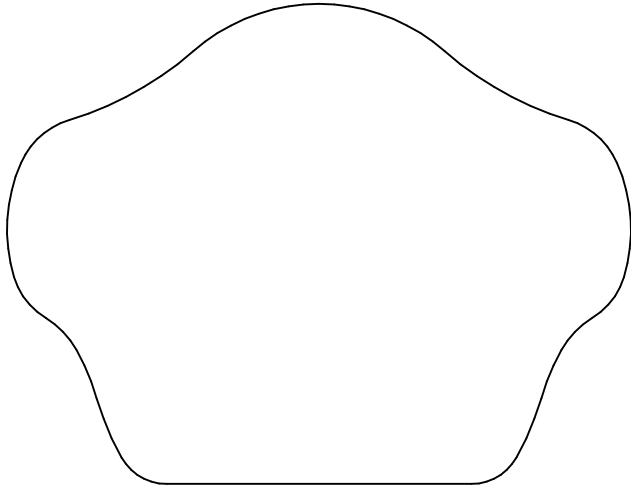

KL 4912
2.500 x 3.250

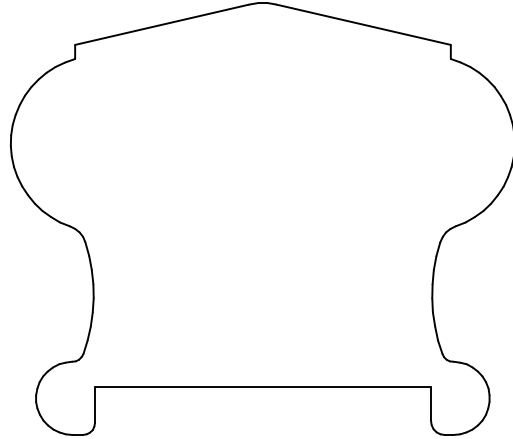

KL 4913P
2.250 x 2.625

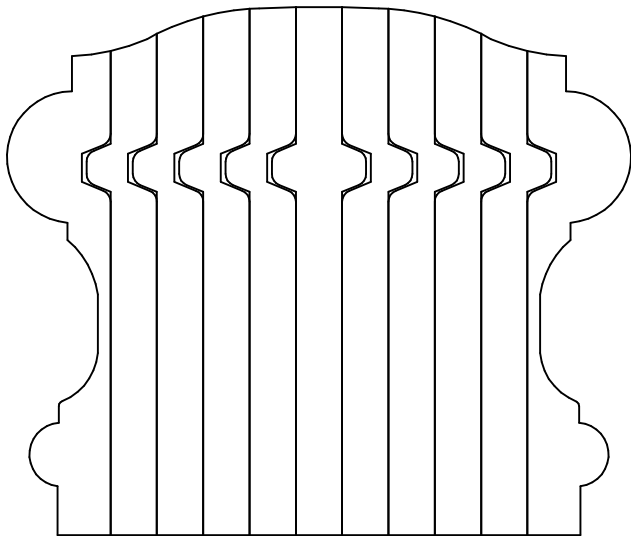

KL 4914B
2.750 x 3.250

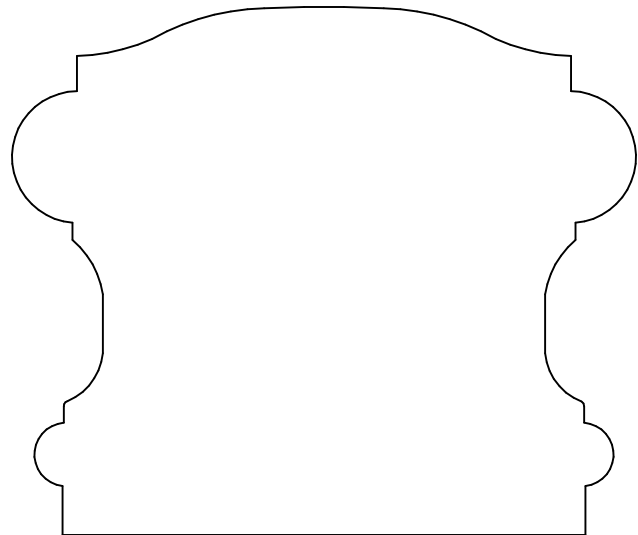

KL 4914
2.750 x 3.250

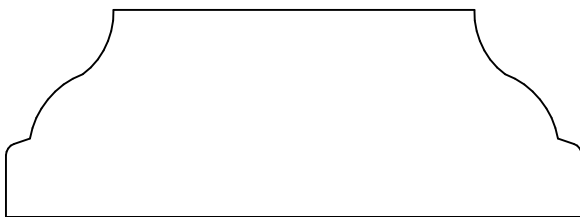

KL 4919
1.078 x 3.000

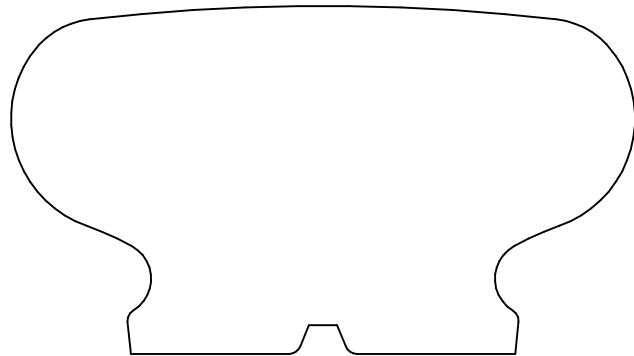

KL 4920
1.812 x 3.250

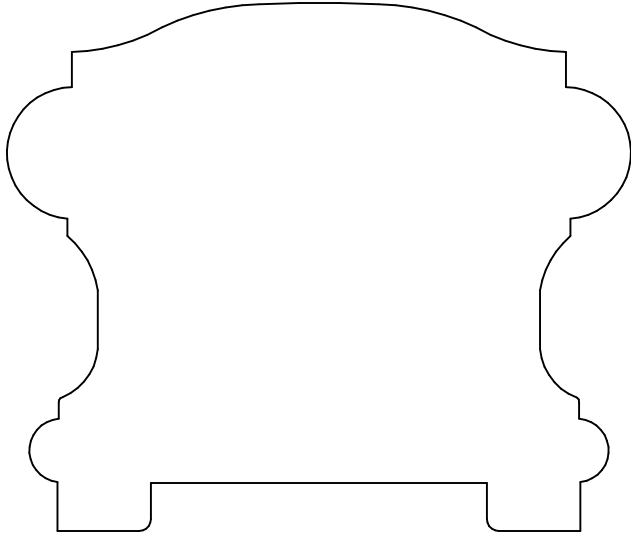

KL 4914 P
2.750 x 3.250

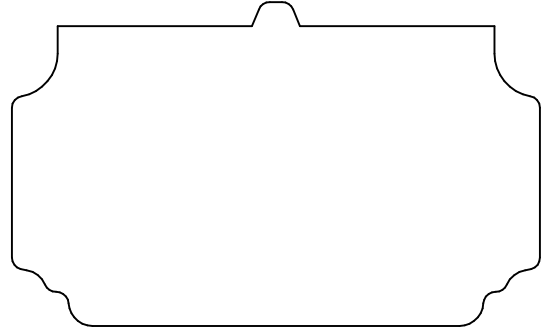

KL 4921
1.562 x 2.750

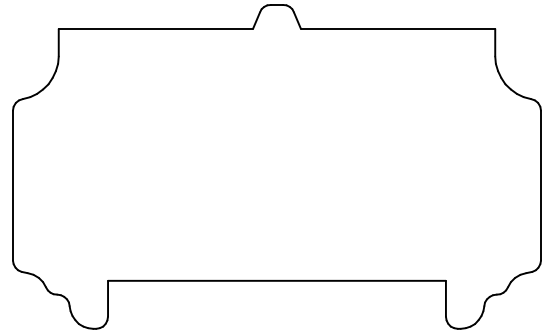

KL 4921P
1.687 x 2.750

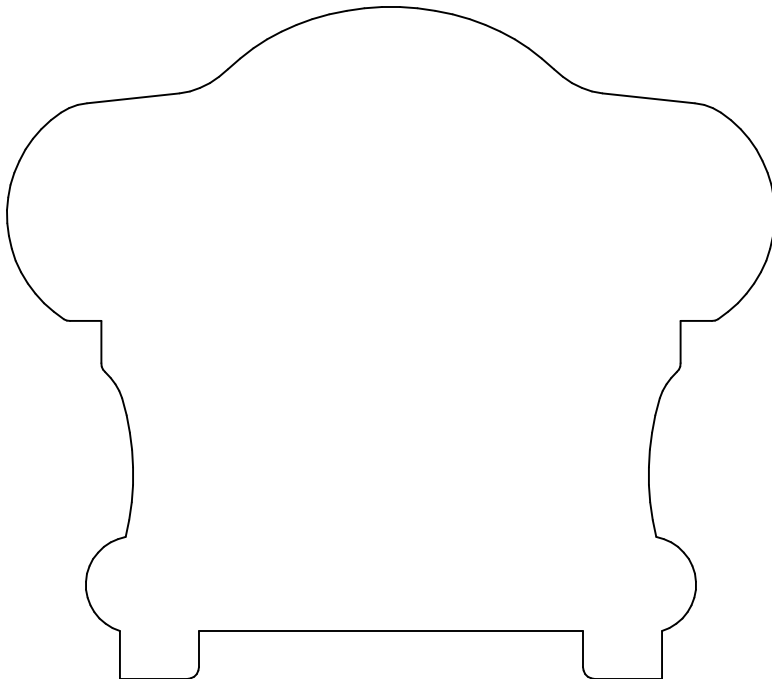

KL 4915P
3.500 x 4.000



KL 4922P
1.375 x 2.750

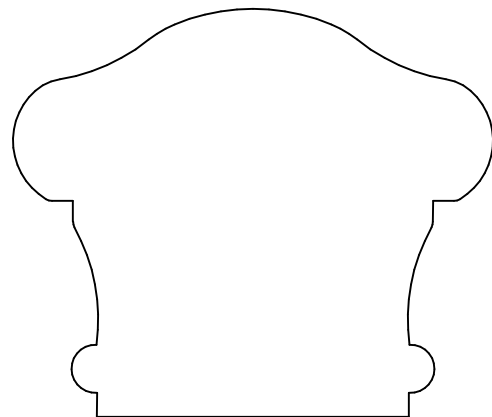

KL 4923
2.125 x 2.500

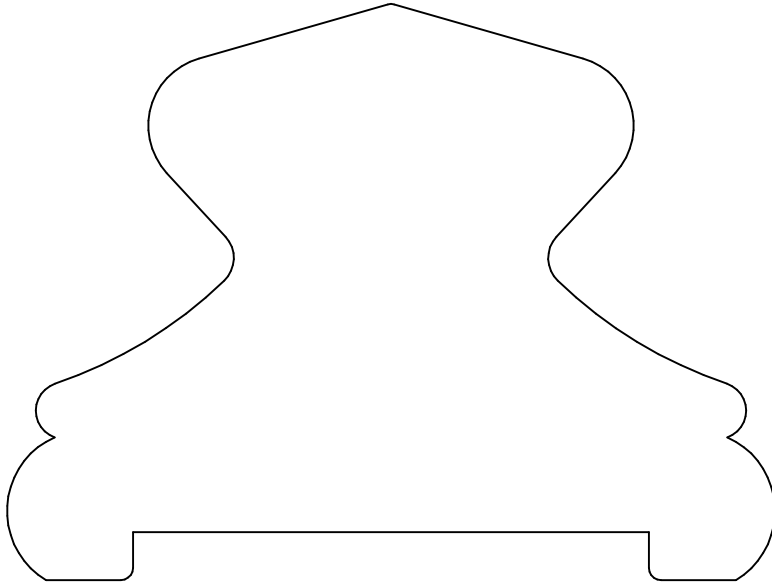

KL 4917P
3.000 x 4.000

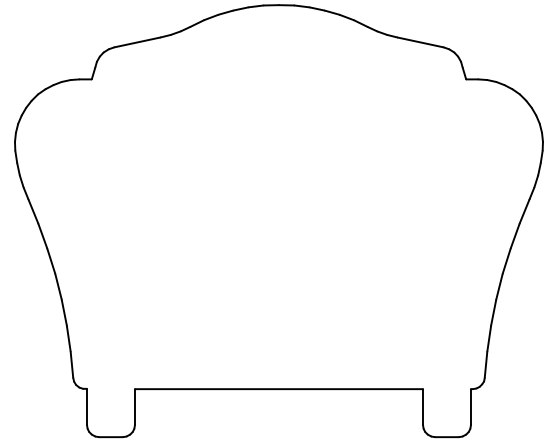

KL 4924P
2.250 x 2.750

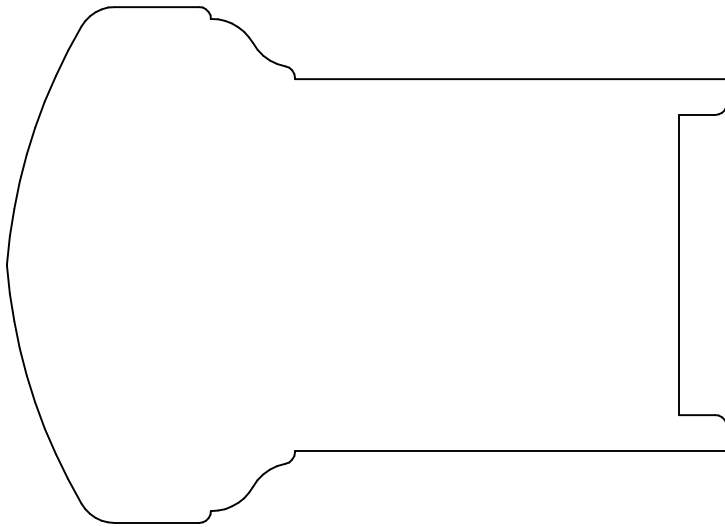

KL 4925P
3.750 x 2.688

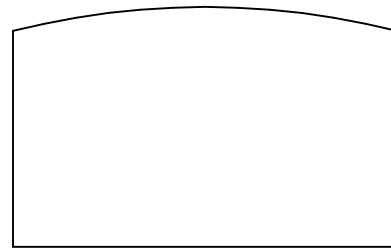

KL 4933
1.250 x 2.000

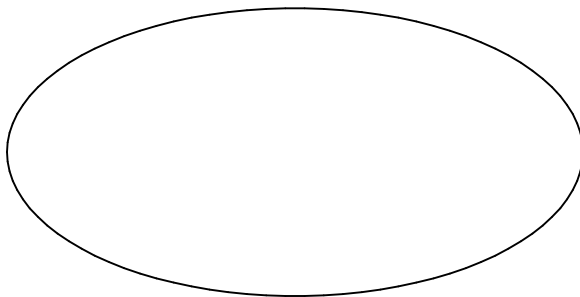

KL 4937
1.500 x 3.000

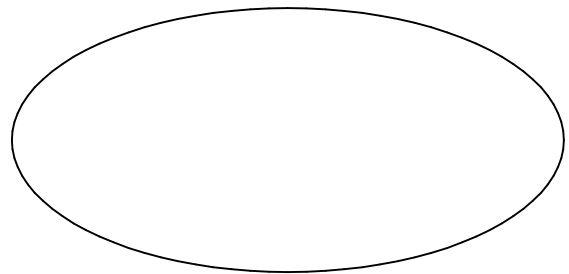

KL 4936
1.375 x 2.875

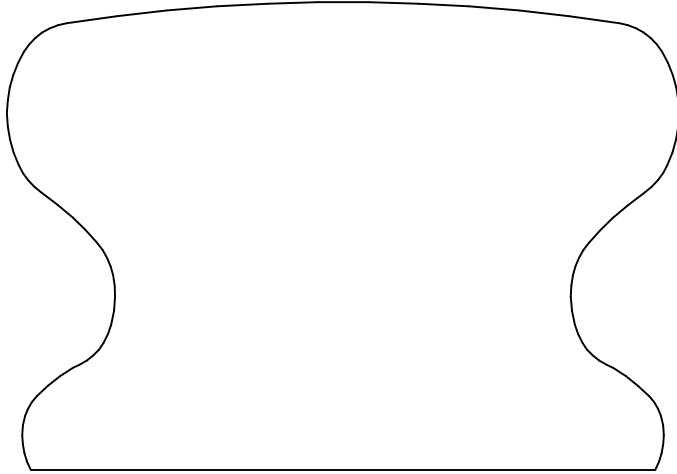

KL 4926
2.438 x 3.500

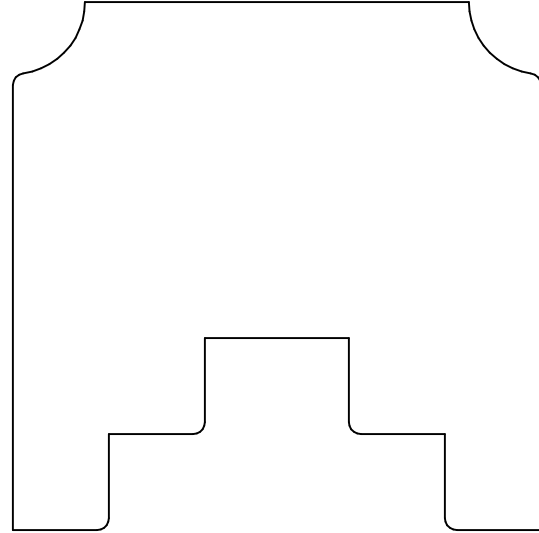

KL 4927P
2.750 x 2.750

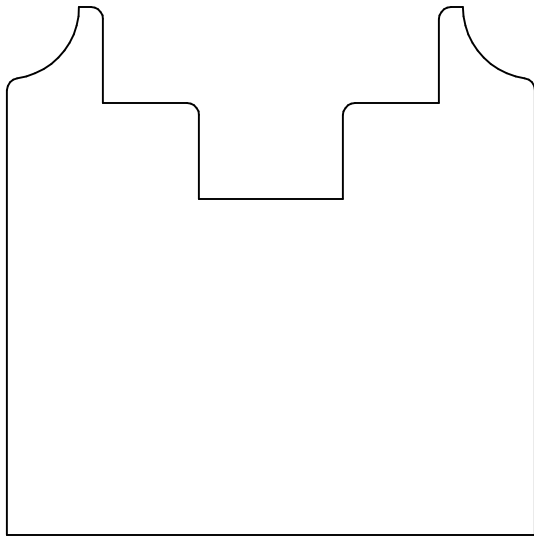

KL 4928P
2.750 x 2.750

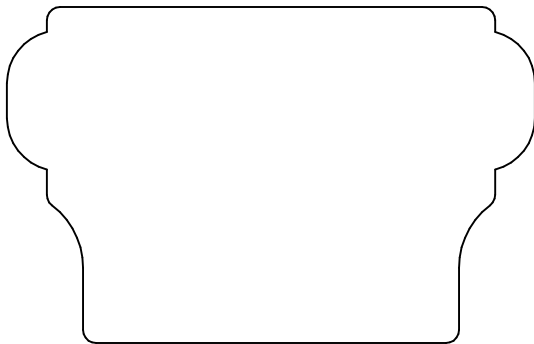

KL 4935
1.750 x 2.750

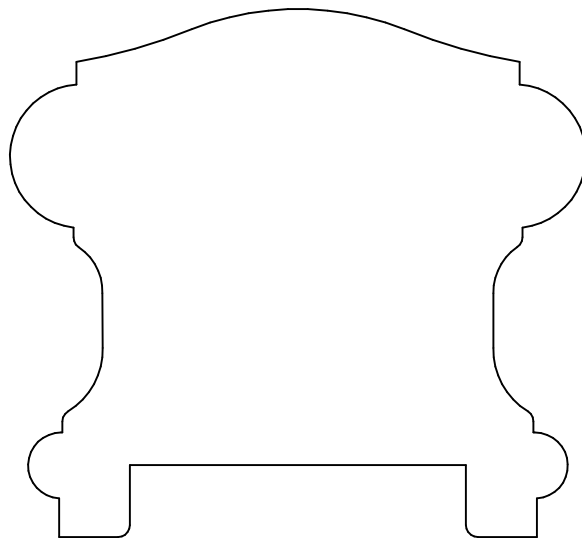

KL 4930P
2.750 x 3.000

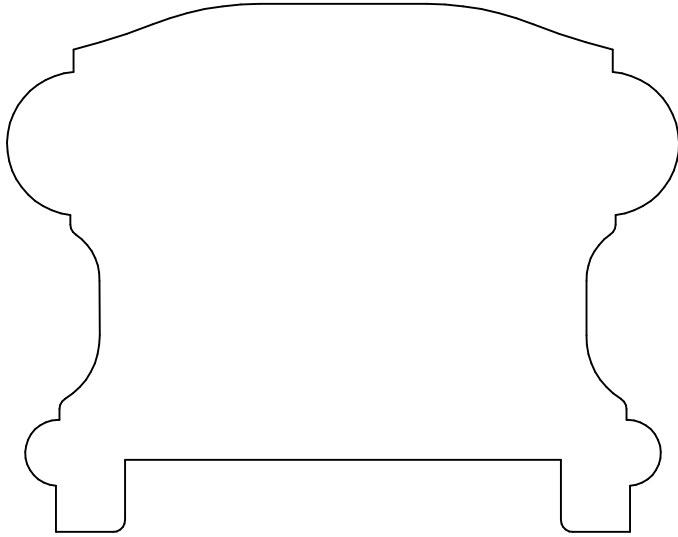

KL 4931P
2.750 x 3.500

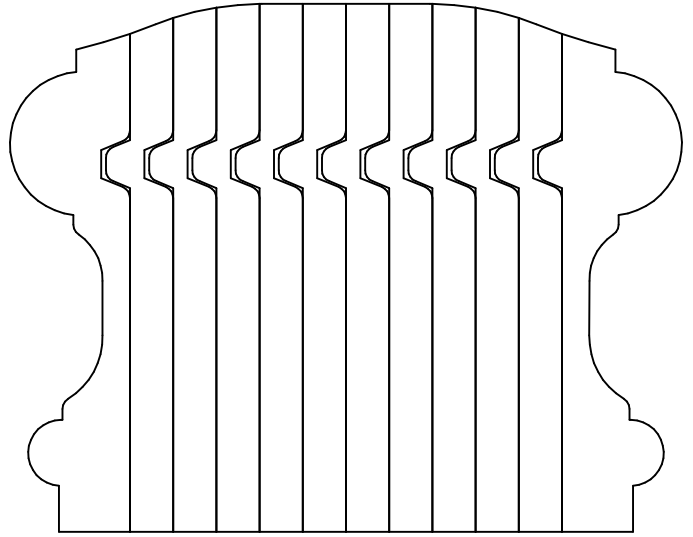

KL4931B
2.750 x 3.500

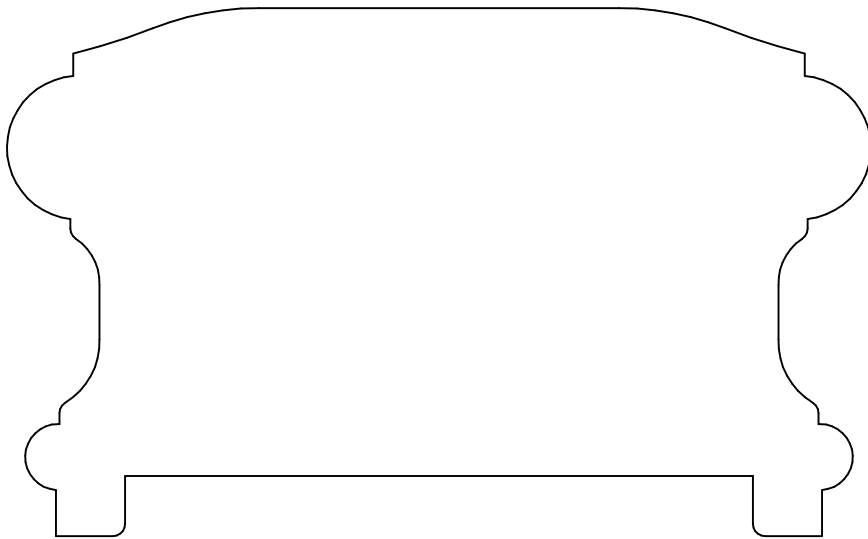

KL 4932P
2.750 x 4.500

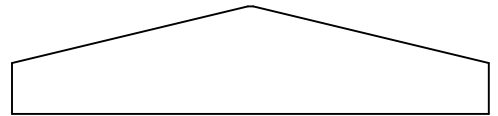

KL 4942
.562 x 2.484

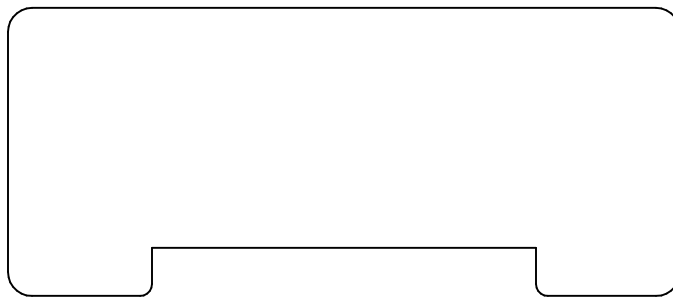

KL 4938P
1.500 x 3.500

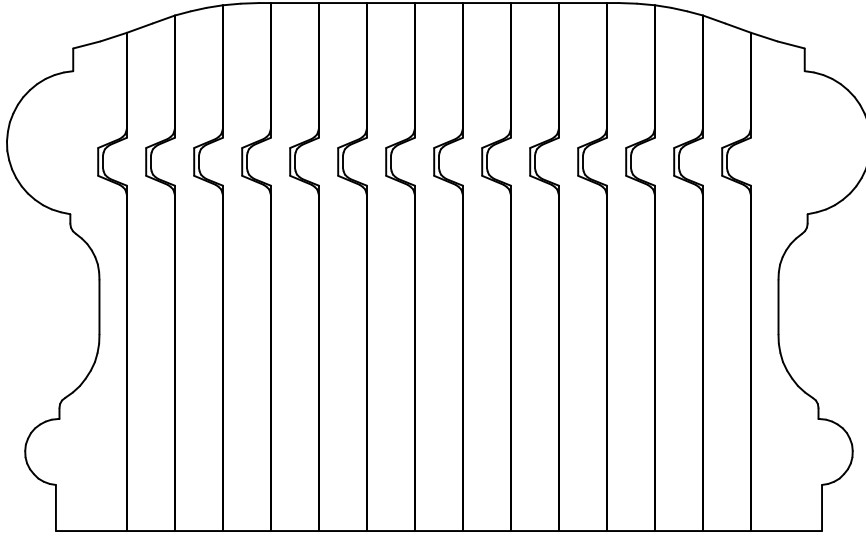

KL 4932B
2.750 x 4.500

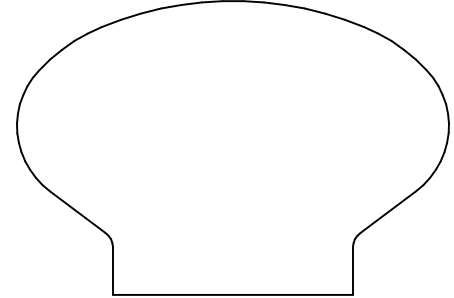

KL 4954
1.531 x 2.250

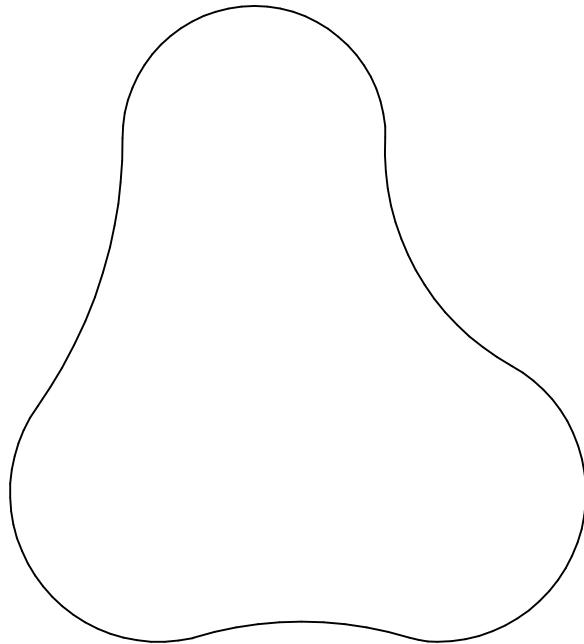

KL 4939
3.312 x 3.000

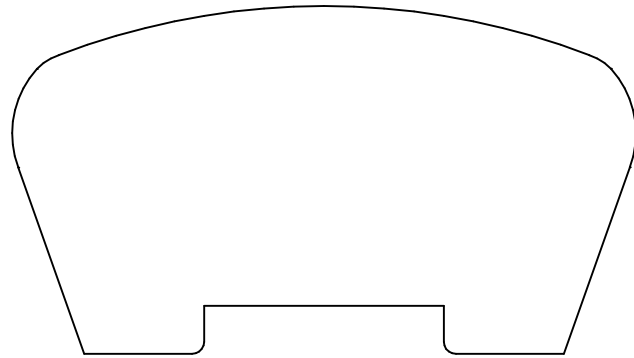

KL 4940P
1.812 x 3.250

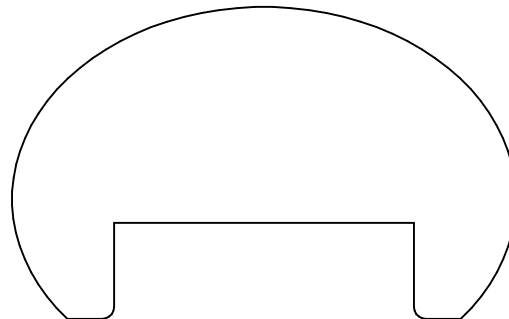

KL 4943P
1.625 x 2.625

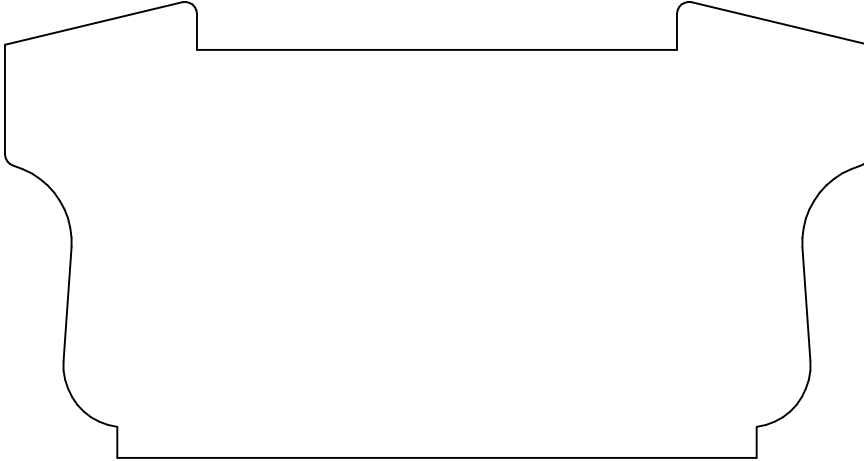

KL 4941P
2.375 x 4.500

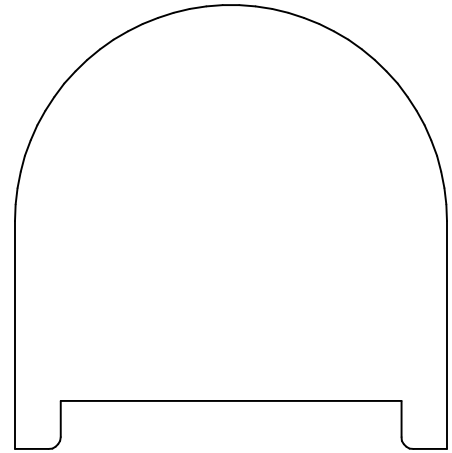

KL 4960P
2.312 x 2.250

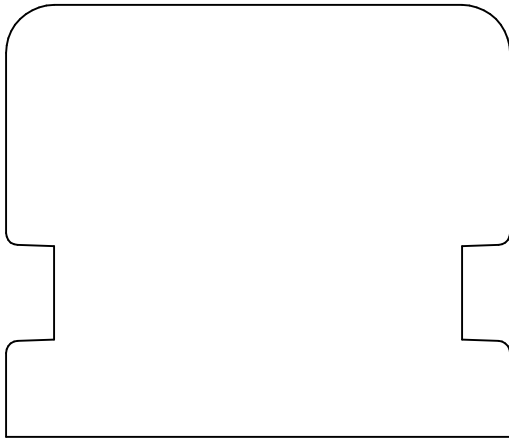

KL 4944
2.250 x 2.625

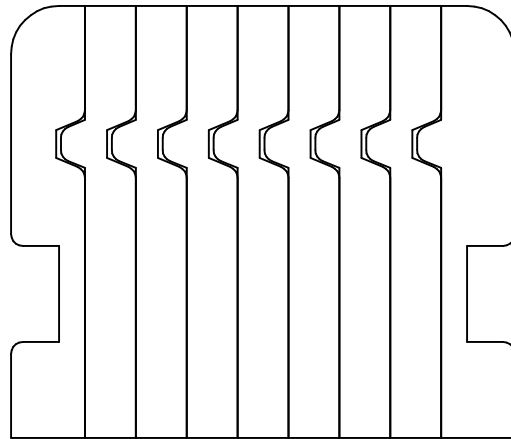

KL 4944B
2.250 x 2.625

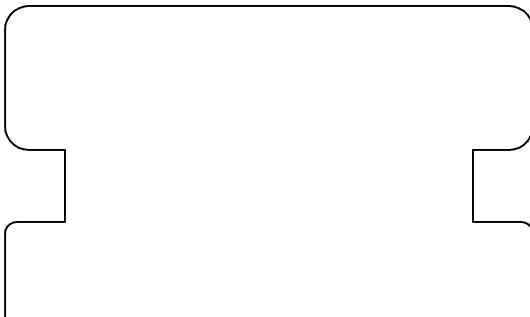

KL 4951
1.625 x 2.750

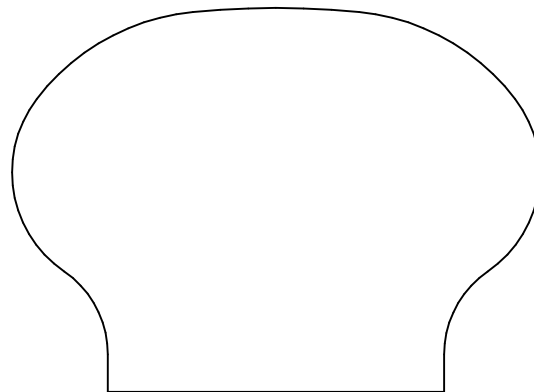

KL 4952
2.000 x 2.750

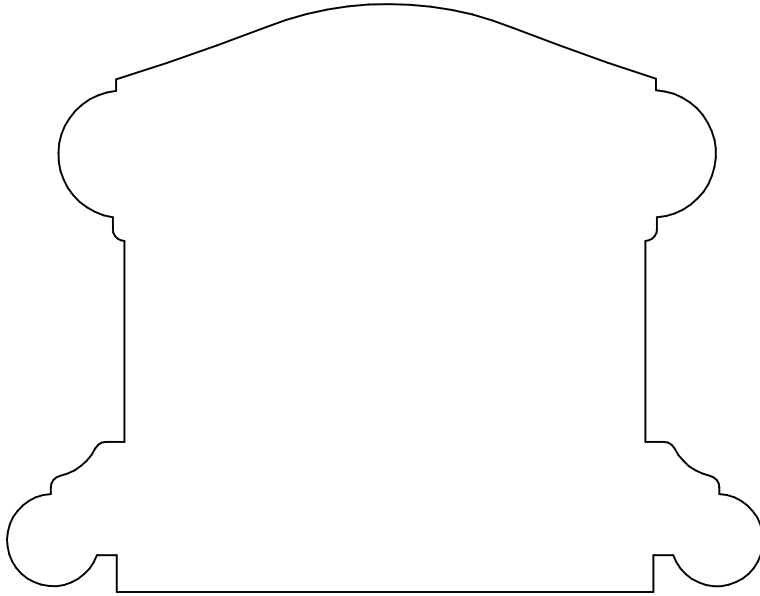

KL 4945
3.062 x 3.938

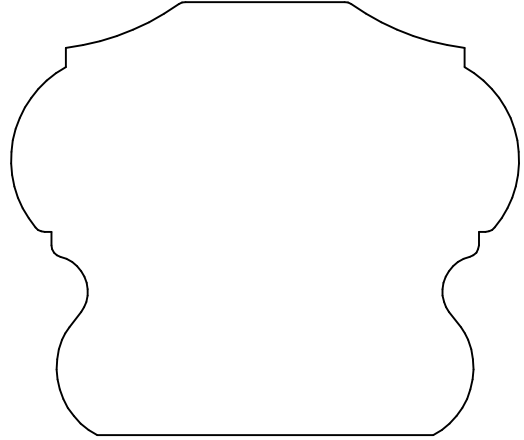

KL 4947
2.256 x 2.646

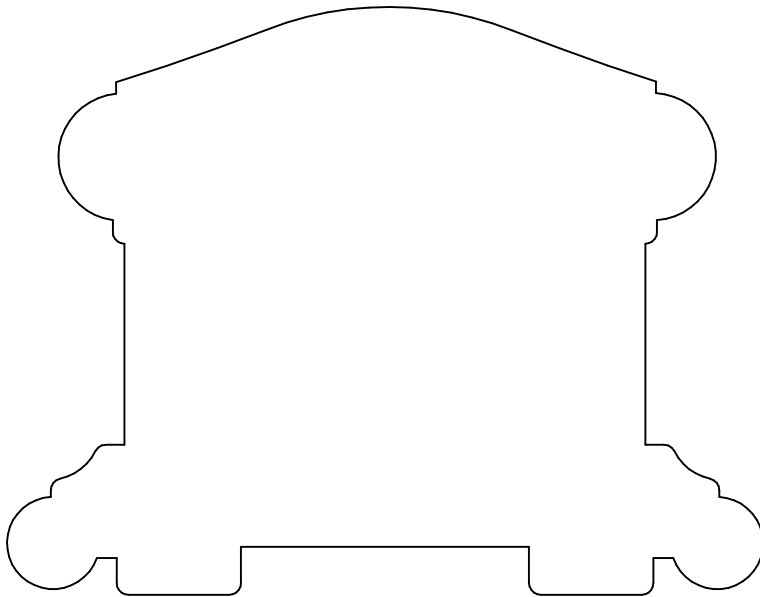

KL 4945P
3.062 x 3.938

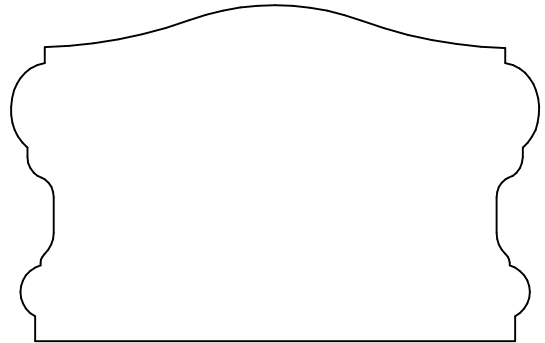

KL 4955
1.750 x 2.750

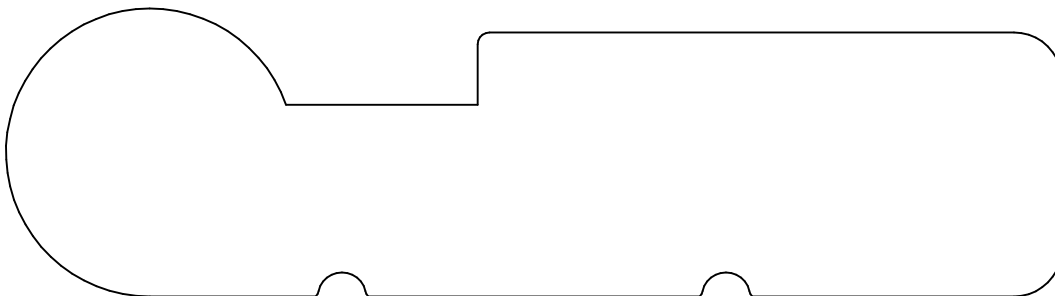

KL 4964
1.500 x 5.500

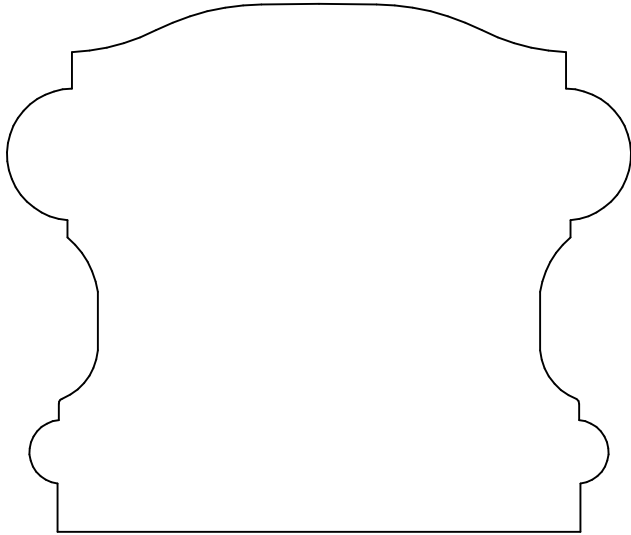

KL 4946
2.750 x 3.250

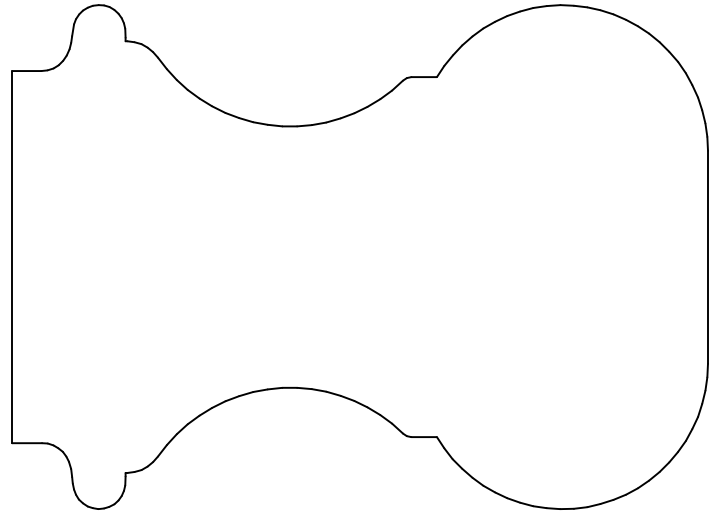

KL 4950
3.625 x 2.625

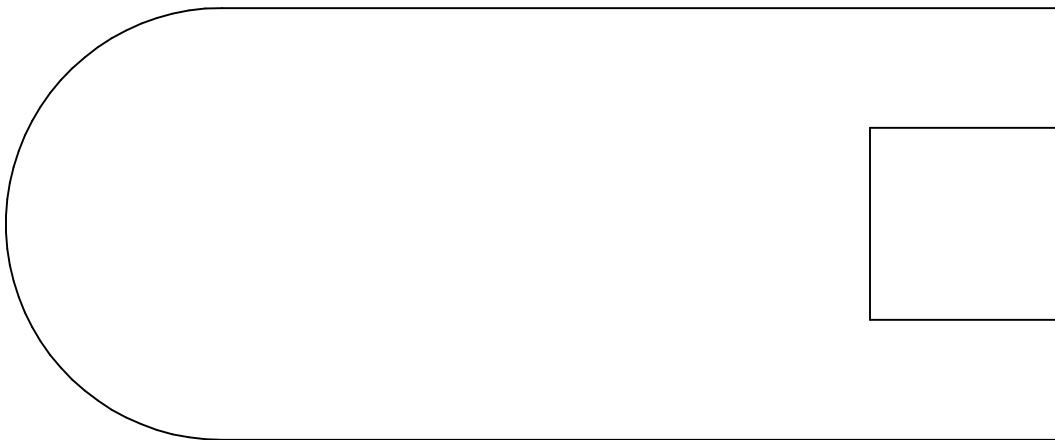

KL 4948P
2.250 x 5.500

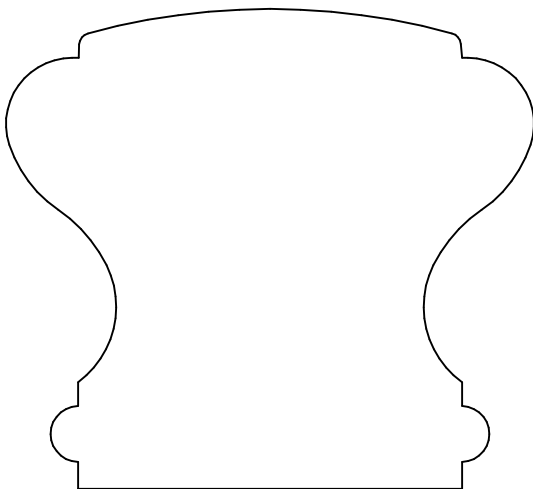

KL 4956
2.500 x 2.750

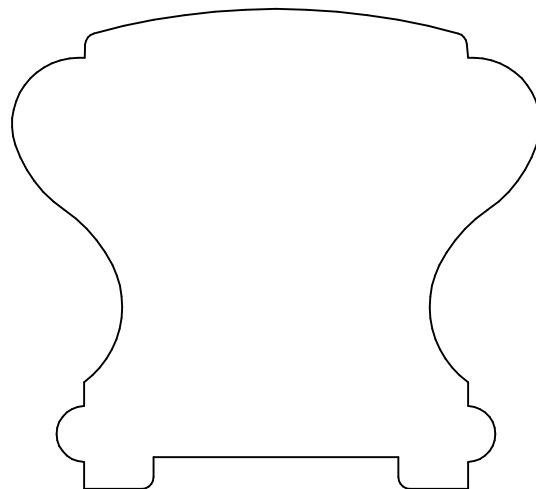

KL 4956P
2.500 x 2.750

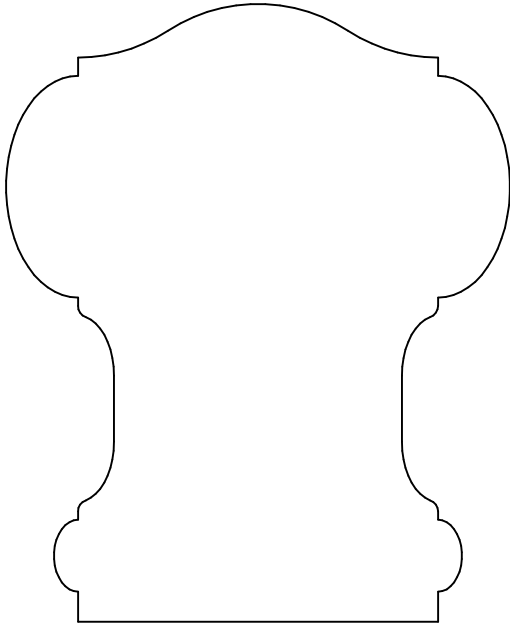

KL 4953
3.218 x 2.625

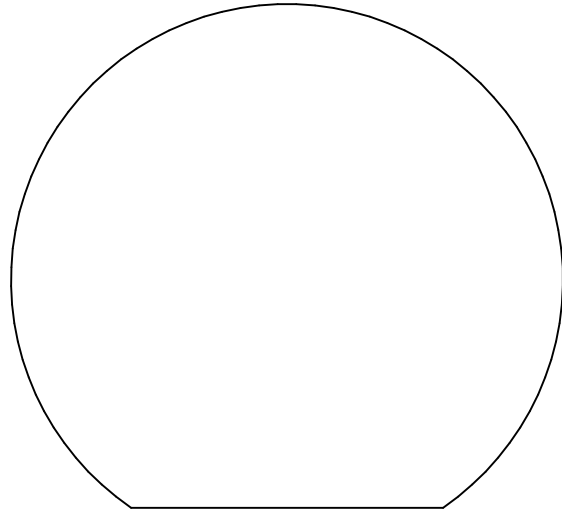

KL 4957
2.623 x 2.875

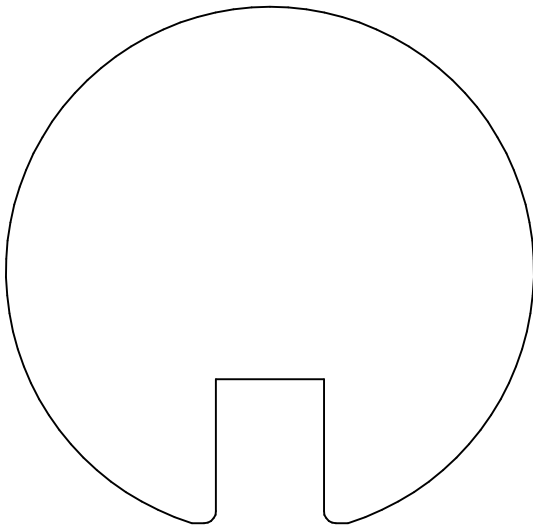

KL 4958P
2.689 x 2.750

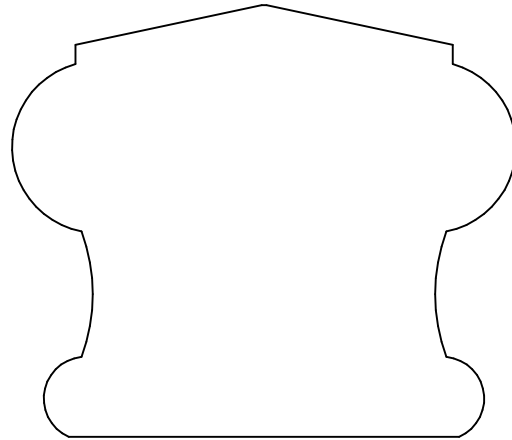

KL 4959
2.250 x 2.625

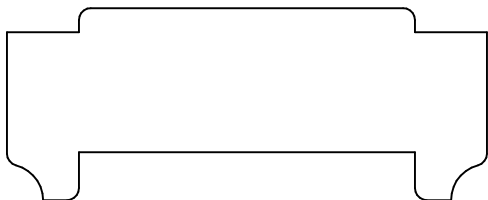

KL 4976P
1.000 x 2.500

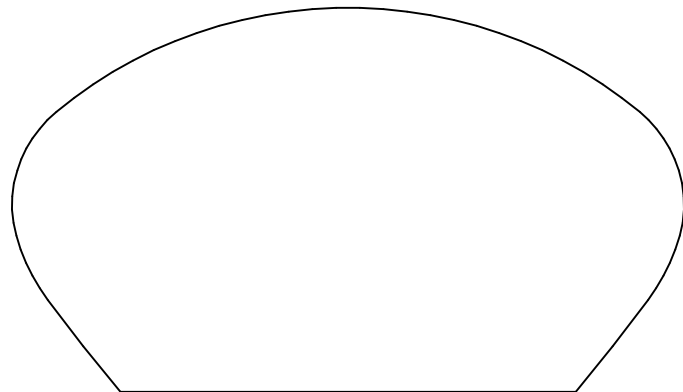

KL 4961
2.000 x 3.500

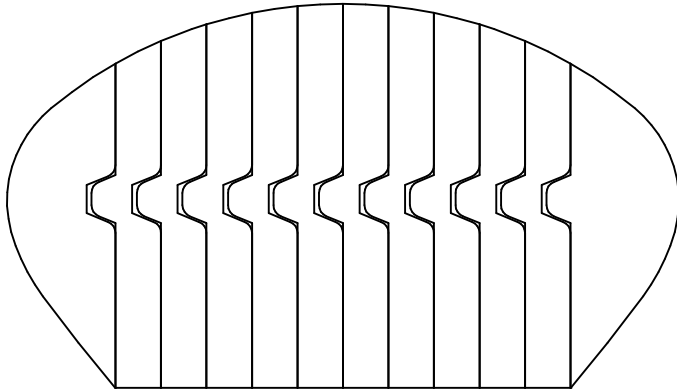

KL 4961B
2.000 x 3.500

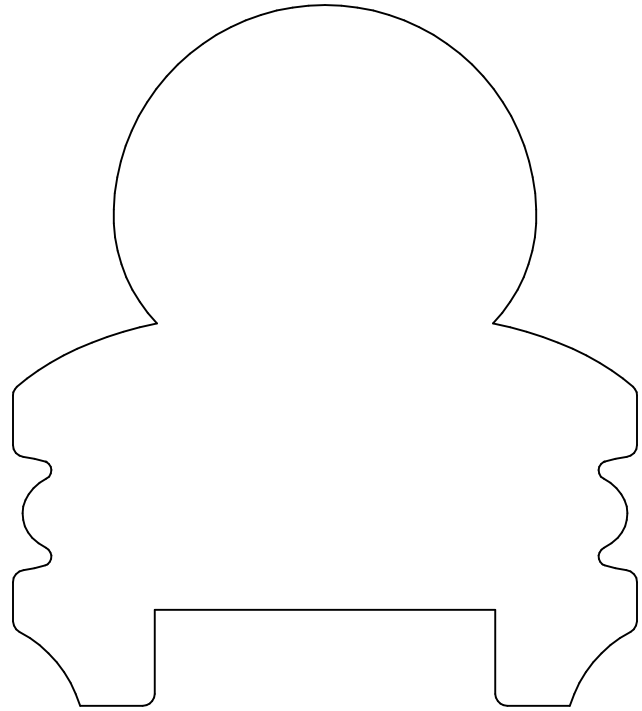

KL 4962P
3.650 x 3.250

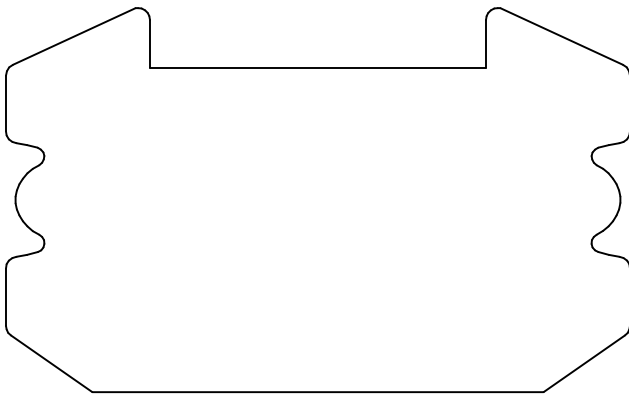

KL 4963P
2.000 x 3.250



KL 4977
.250 x 1.750

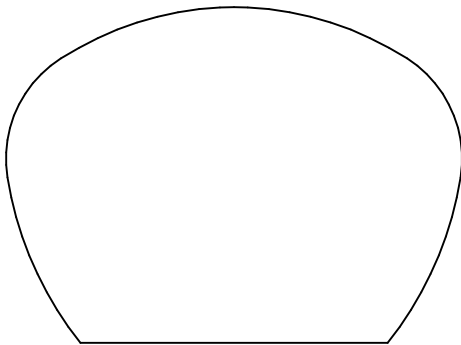

KL 4965
1.750 x 2.375



KL 4979P
1.125 x 2.000

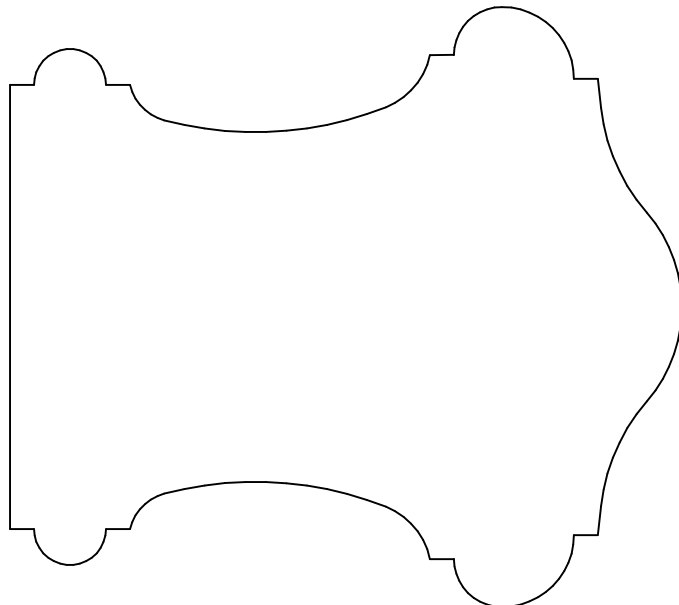

KL 4967
3.500 x 3.125

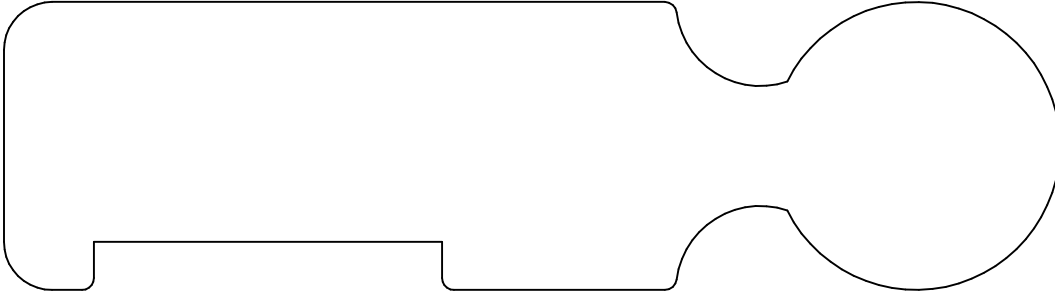

KL 4966
1.500 x 5.500

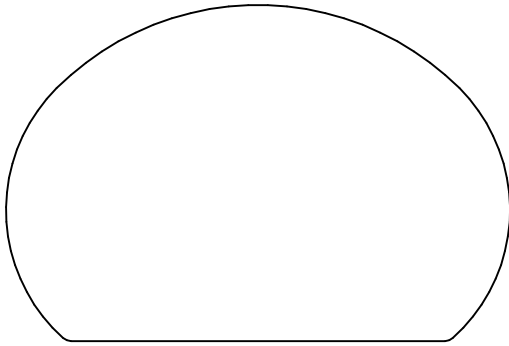

KL 4968
1.750 x 2.625

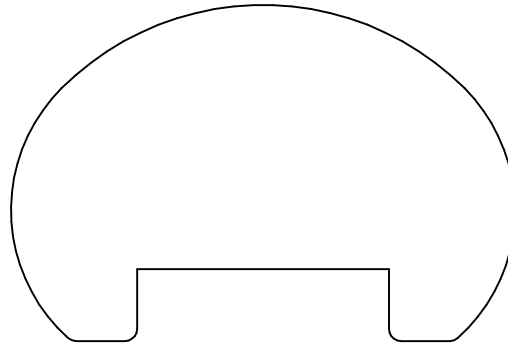

KL 4968P
1.750 x 2.625

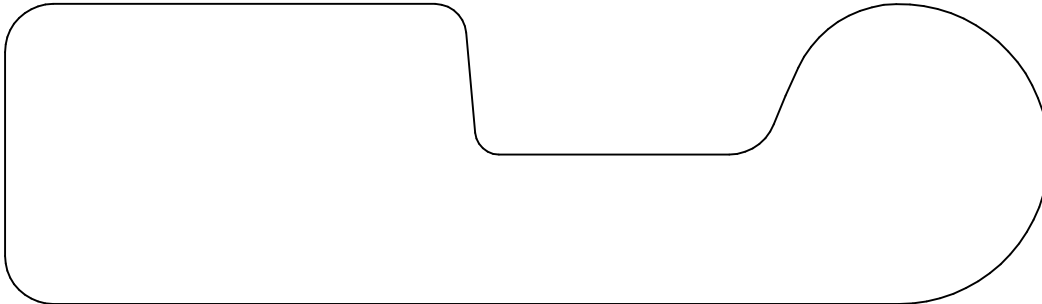

KL 4969
1.562 x 5.437

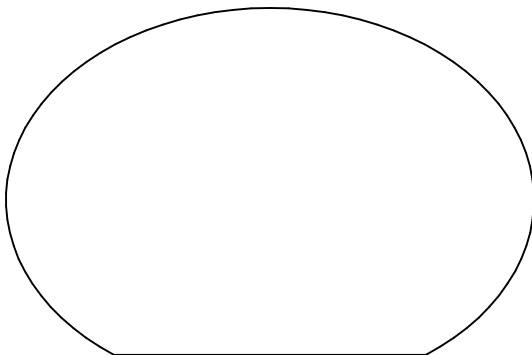

KL 4970
1.807 x 2.750

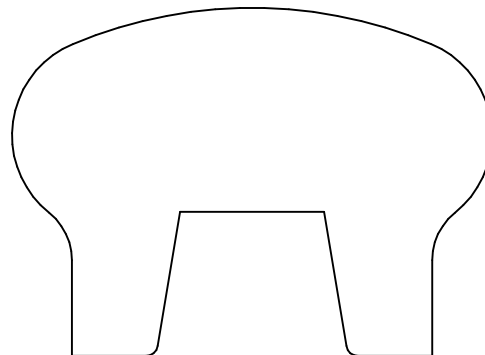

KL 4971P
1.813 x 2.500

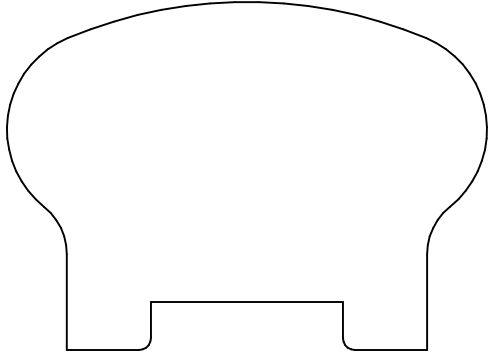

KL 4972P
1.813 x 2.500

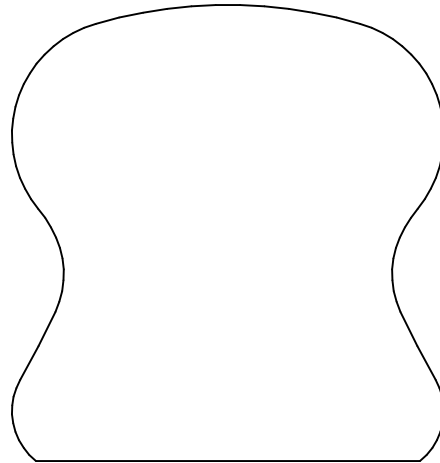

KL 4973
2.375 x 2.250

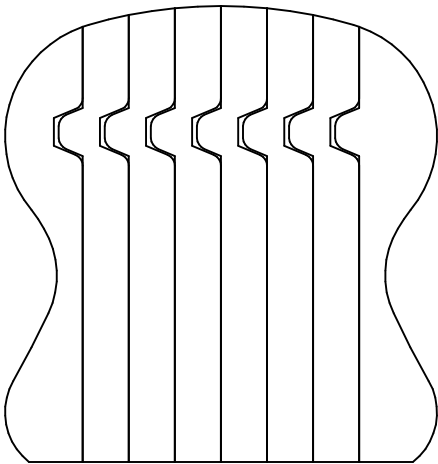

KL 4973B
2.375 x 2.250

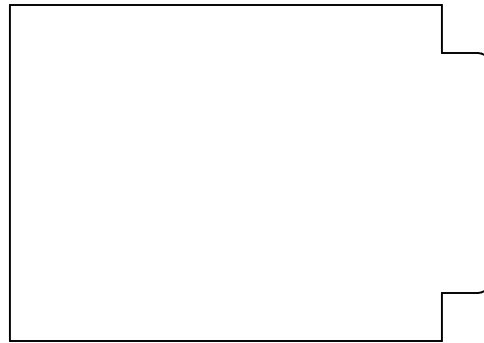

KL 4974
1.750 x 2.500

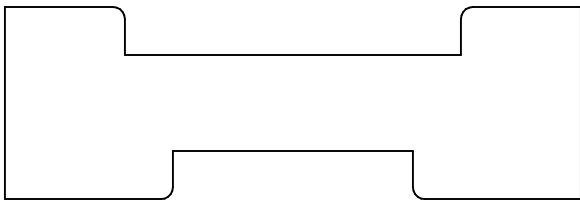

KL 4975P
1.000 x 3.000

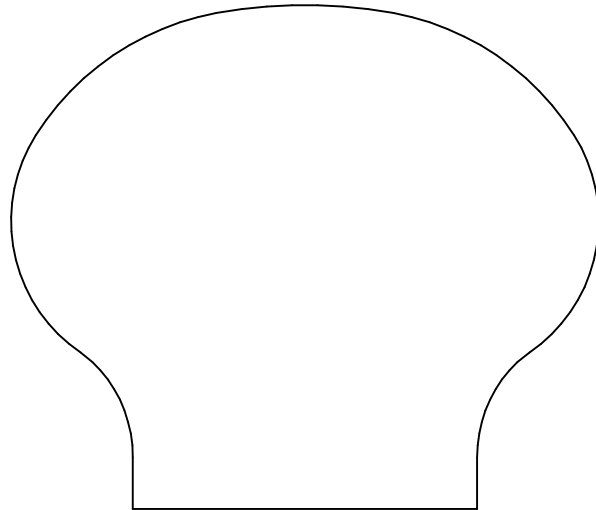

KL 4978
2.625 x 3.062

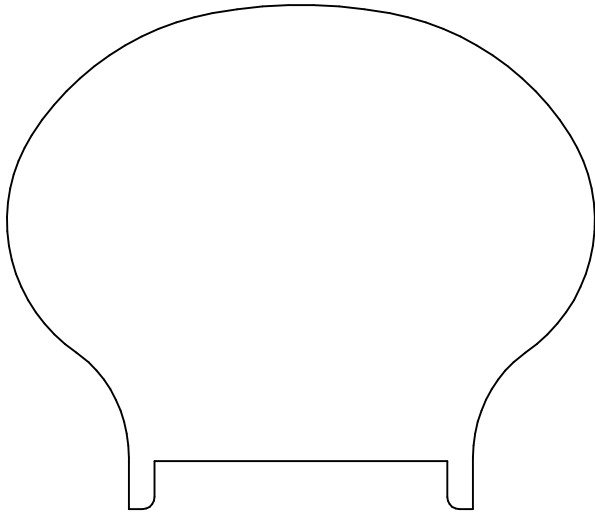

KL 4978P
2.625 x 3.062

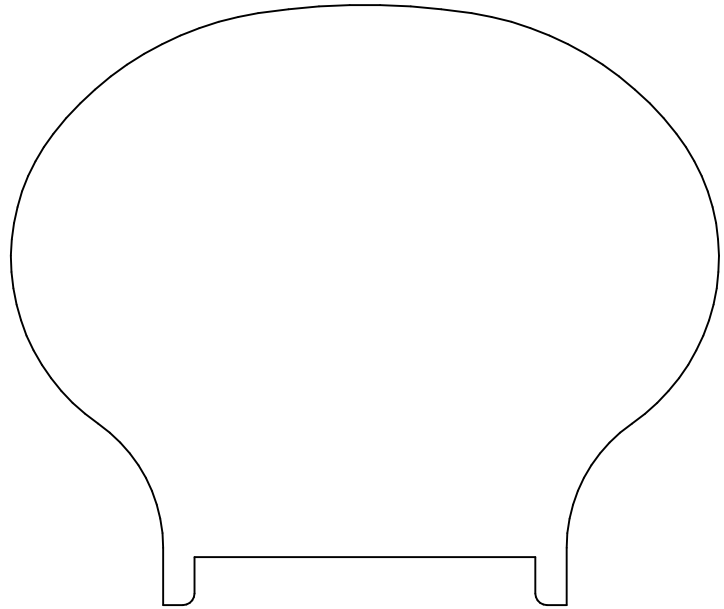

KL 4980P
3.125 x 3.688

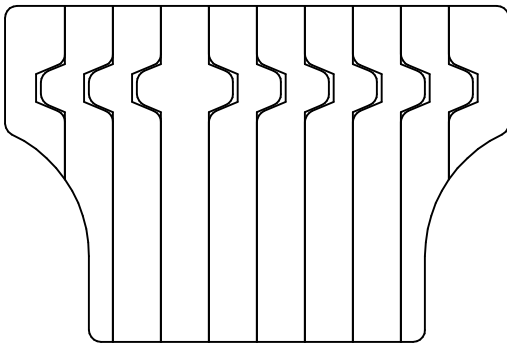

KL 4981B
1.750 x 2.625

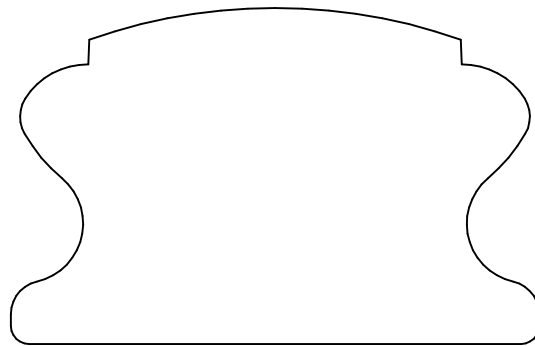

KL 4983
1.750 x 2.750

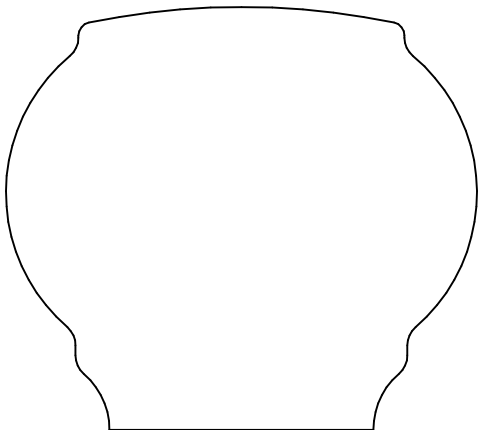

KL 4984
2.203 x 2.453

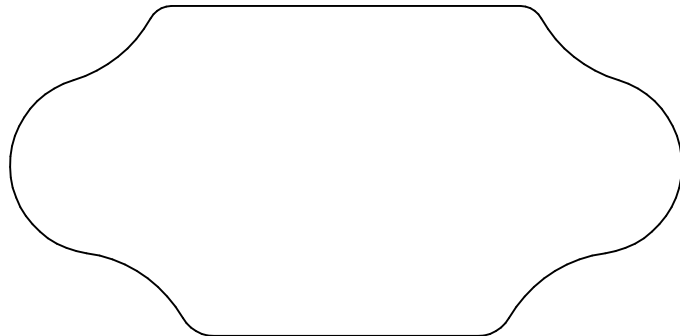

KL 4985
1.719 x 3.500

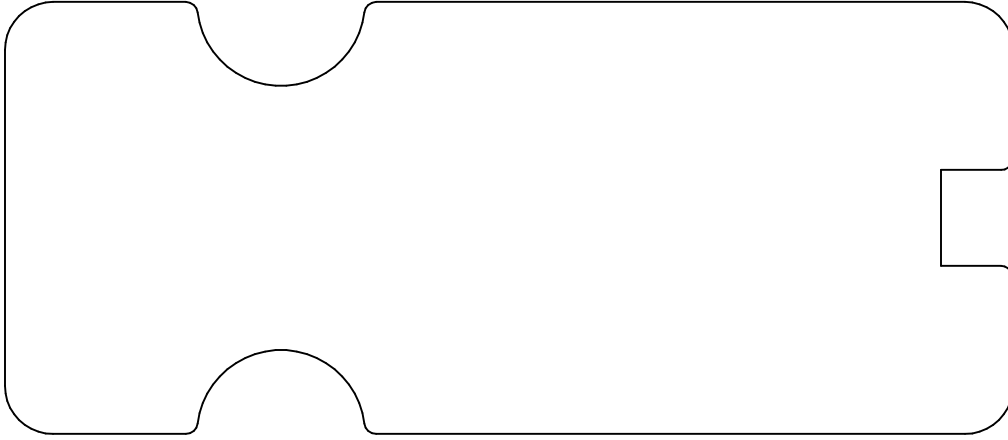

KL 4986P
2.250 x 5.250

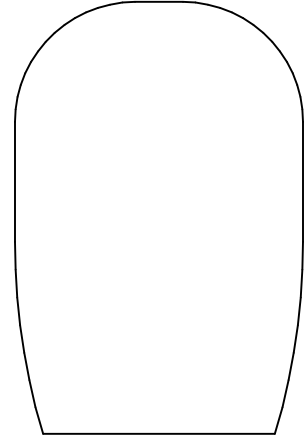

KL4996
2.250 x 1.500

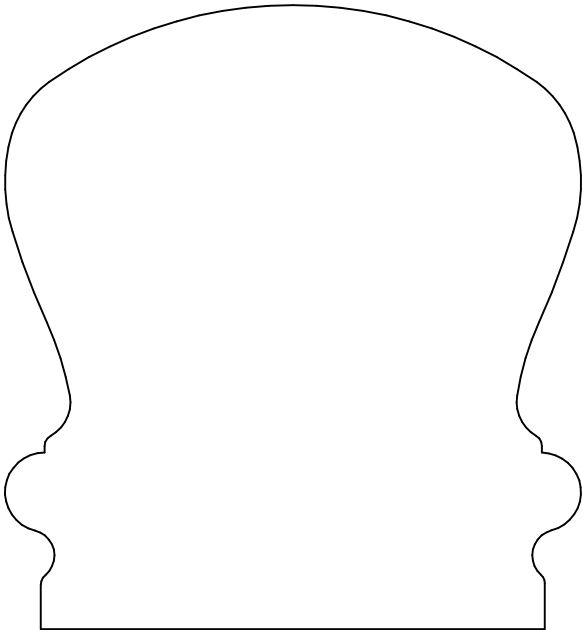

KL 4987
3.250 x 3.000

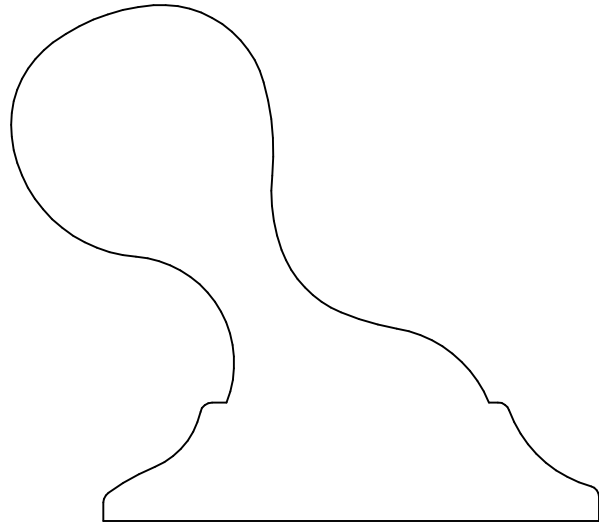

KL 4988
2.687 x 3.062

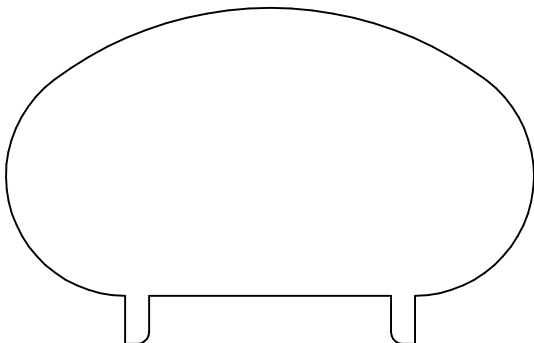

KL 4992P
1.750 x 2.750

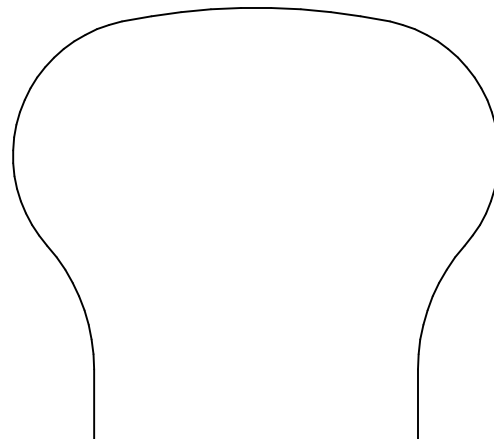

KL 4990
2.250 x 2.531

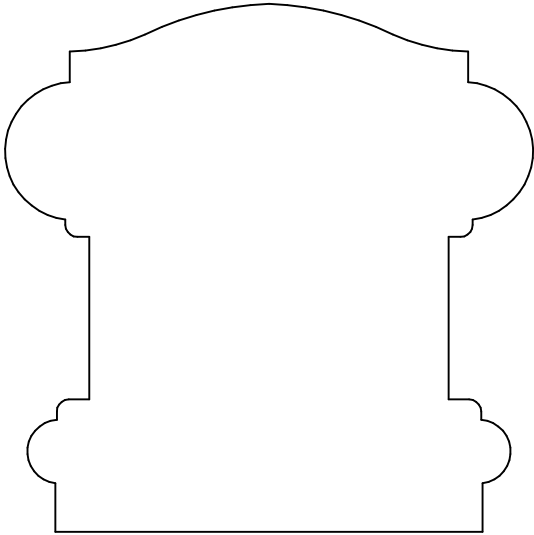

KL 4989
2.750 x 2.750

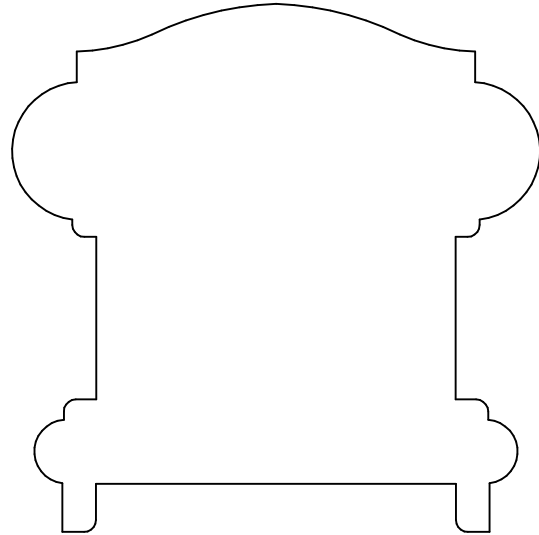

KL 4989P
2.750 x 2.750

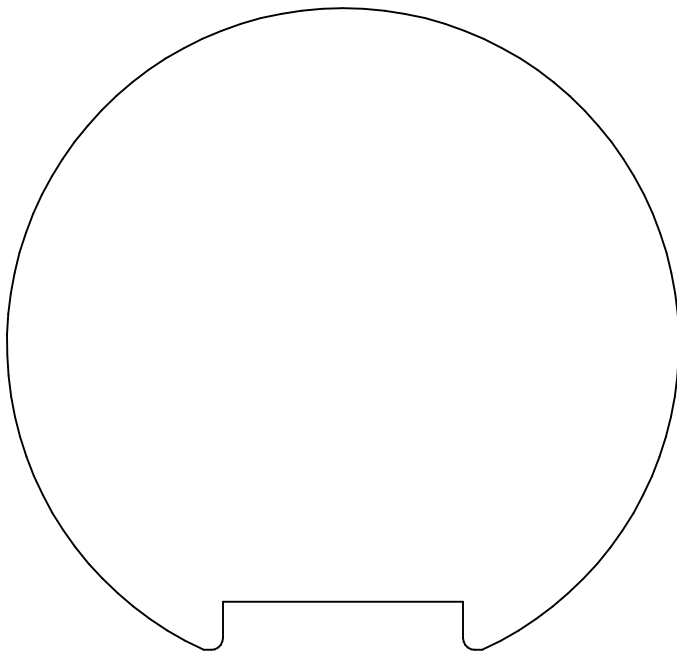

KL 4991P
3.343 x 3.500

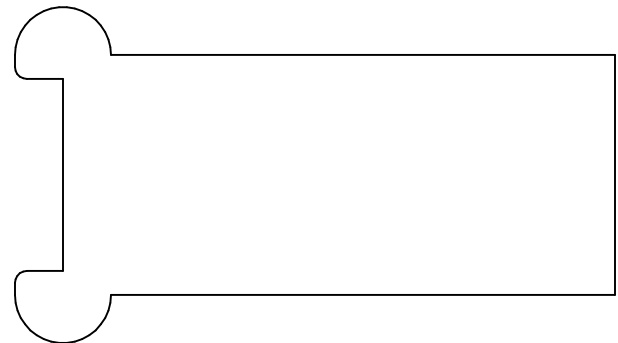

KL 4993P
1.750 x 3.125

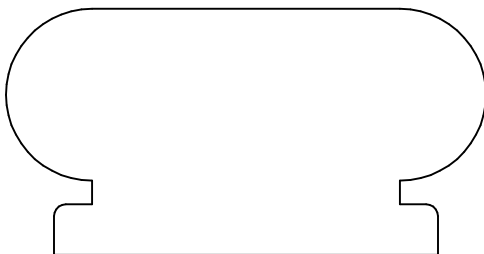

KL 4998
1.281 x 2.500

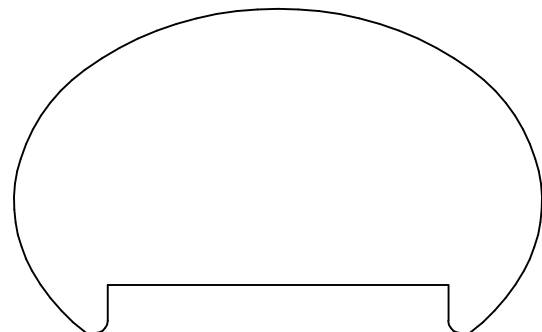

KL 4994P
1.687 x 2.750

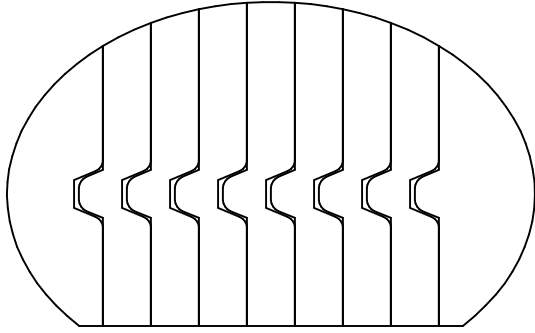

KL 4994B
1.683 x 2.750

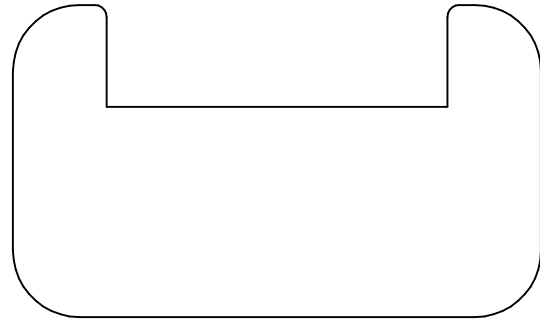

KL 5906P
1.625 x 2.750

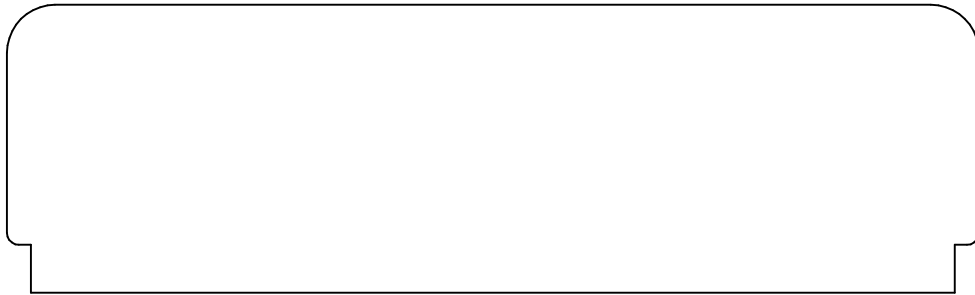

KL 4995
1.500 x 5.062

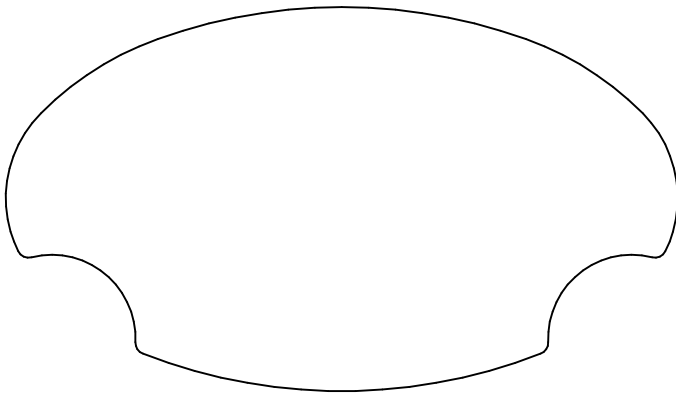

KL 4997
2.000 x 3.500

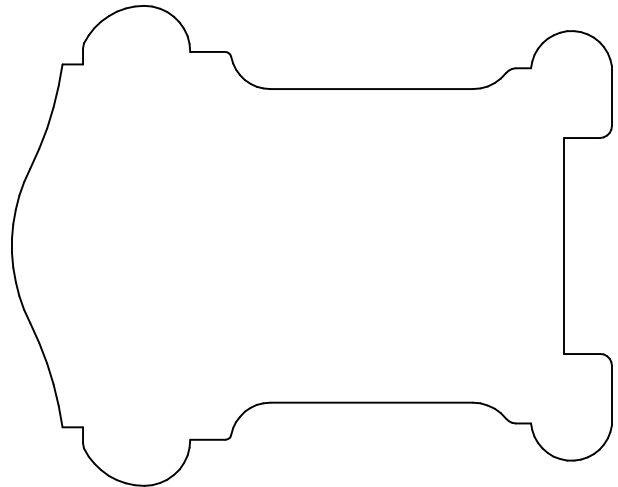

KL 4999P
3.125 x 2.500

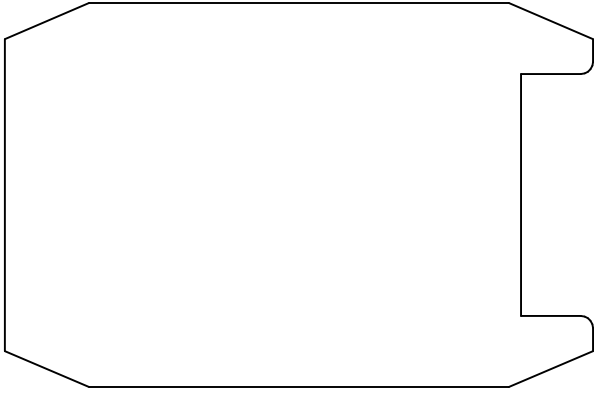

KL 5900P
2.000 x 3.062

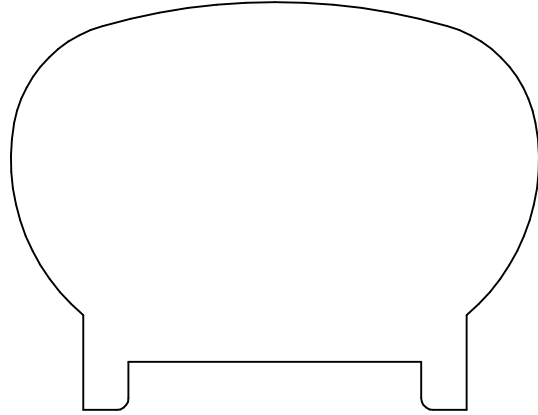

KL 5901P
2.125 x 2.750

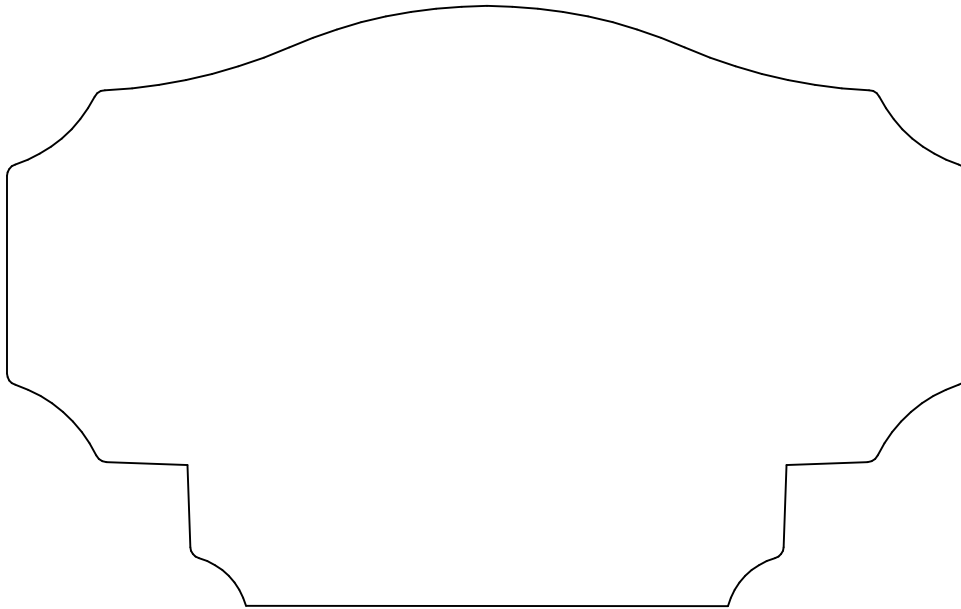

KL 5902
3.125 x 5.000

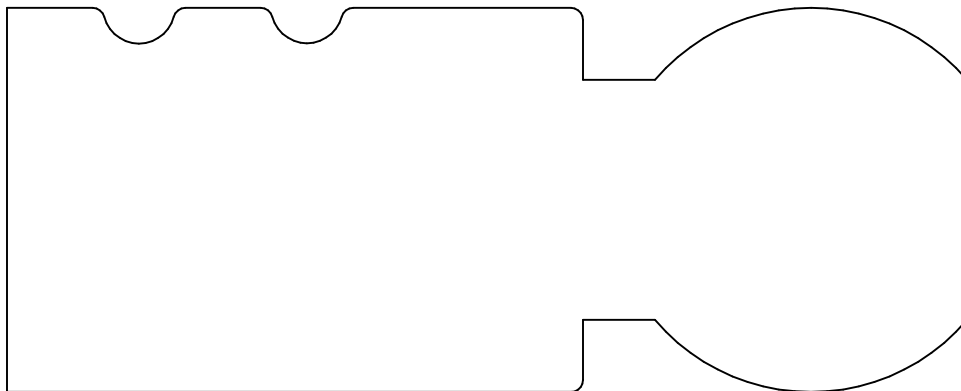

KL 5905
2.000 x 5.000

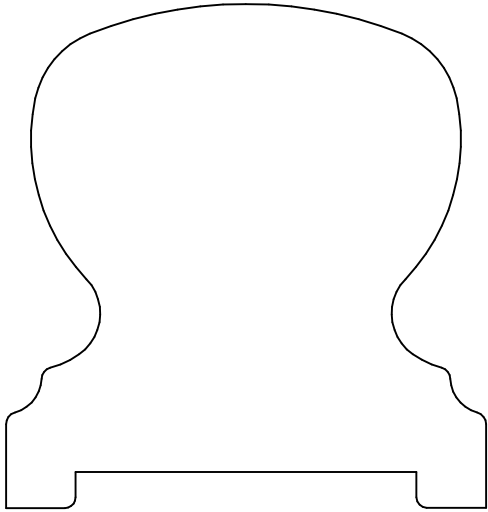

KL 5903P
2.625 x 2.500

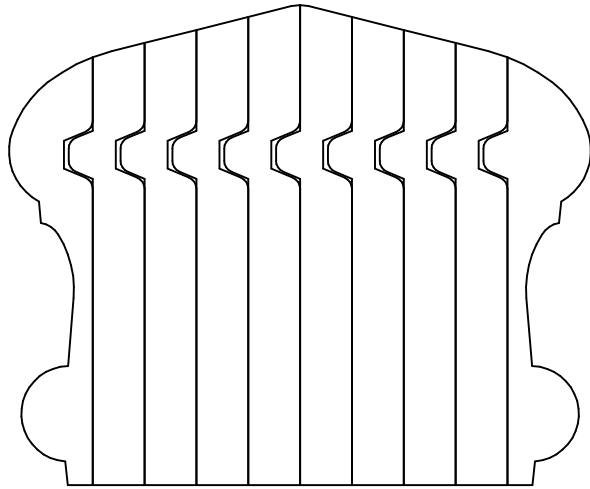

KL 5904B
2.500 x 3.031

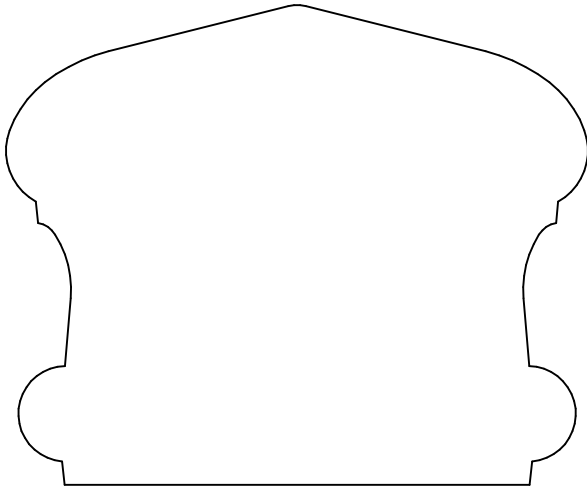

KL 5904
2.500 x 3.031

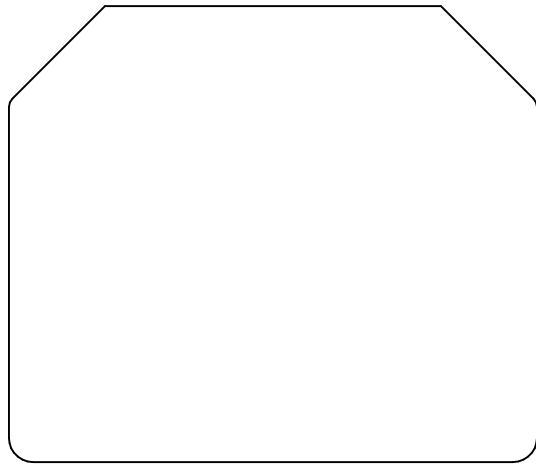

KL 5907
2.375 x 2.750

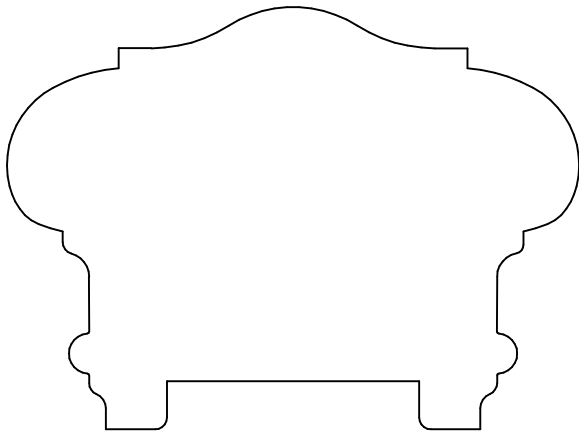

KL 5908P
2.200 x 2.980

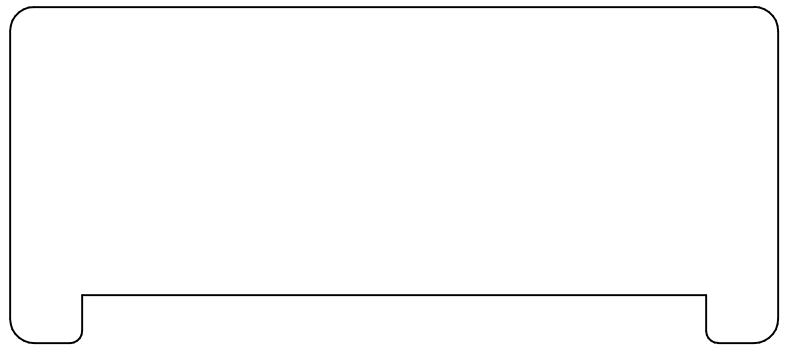

KL5909P
1.750 x 4.000

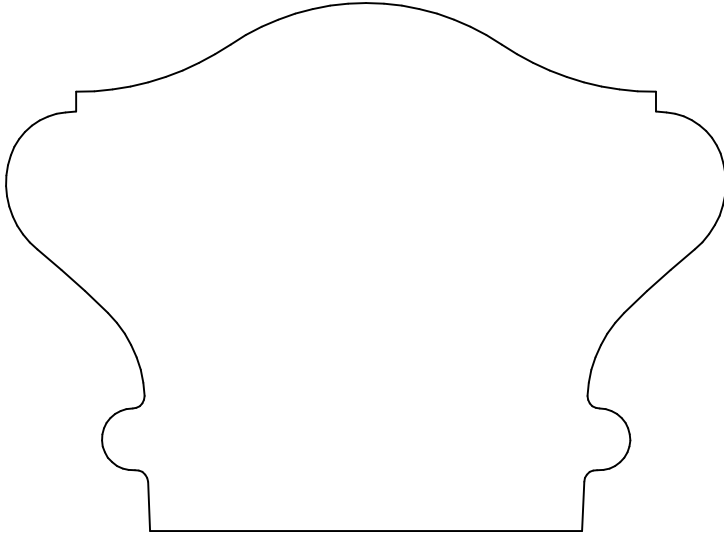

KL 5910
2.750 x 3.750

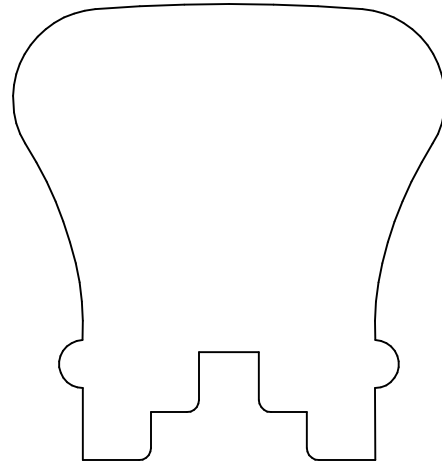

KL 5915P
2.375 x 2.250

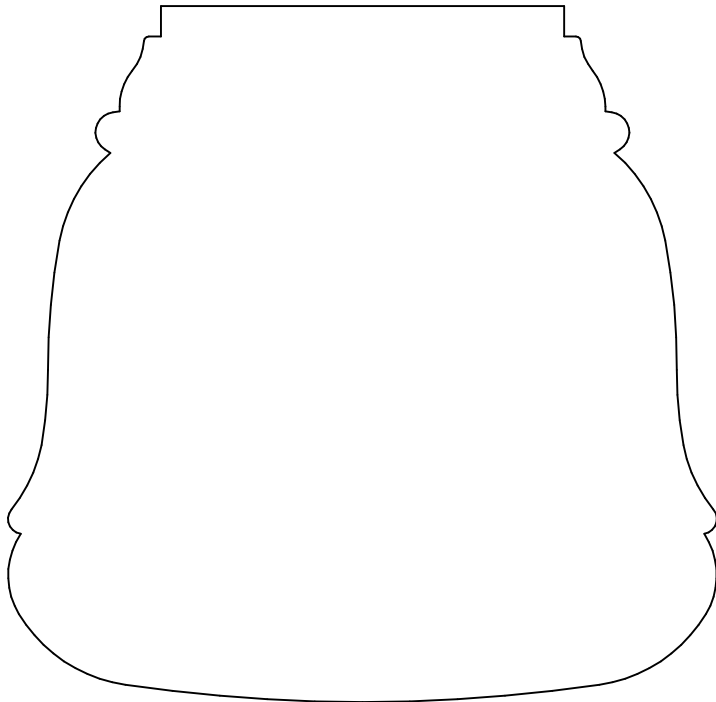

KL 5911
3.625 x 3.690

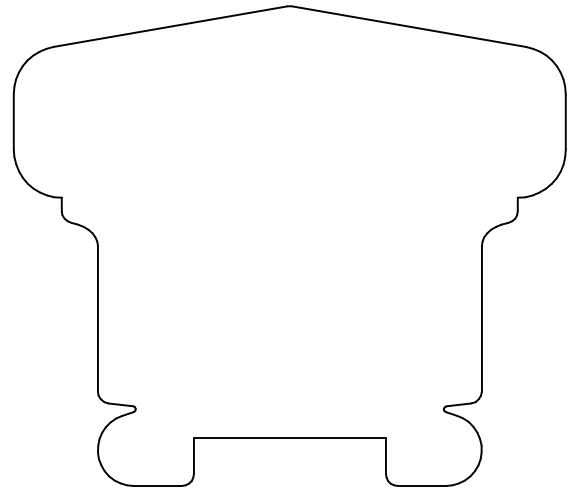

KL 5916P
2.500 x 2.875

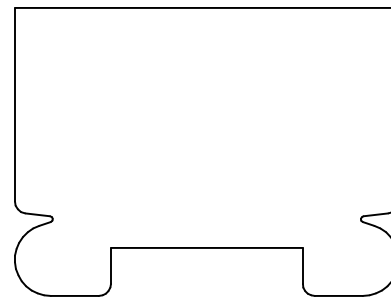

KL 5917P
1.500 x 2.000

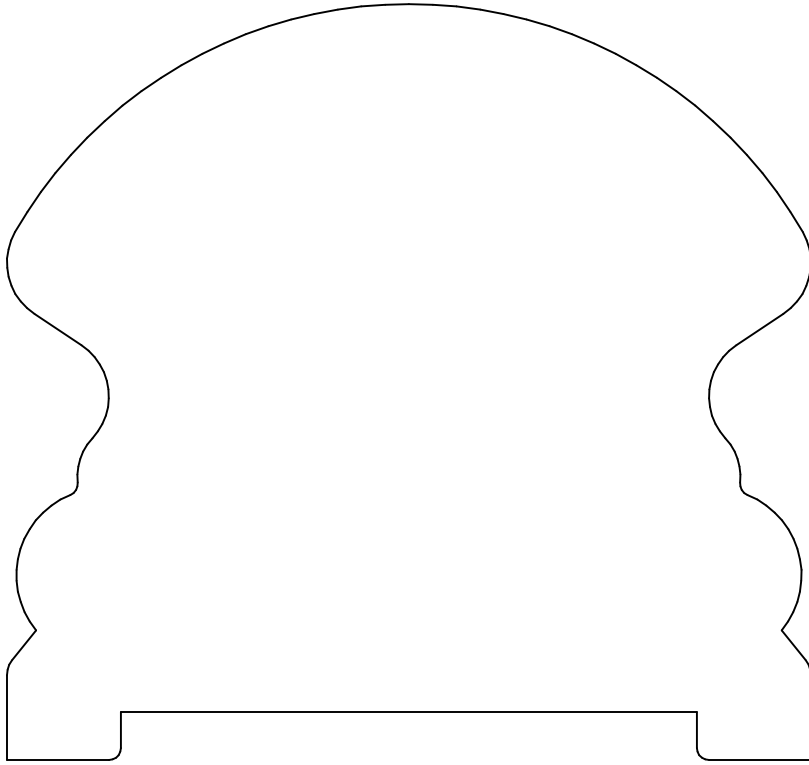

KL 5912P
3.937 x 4.187

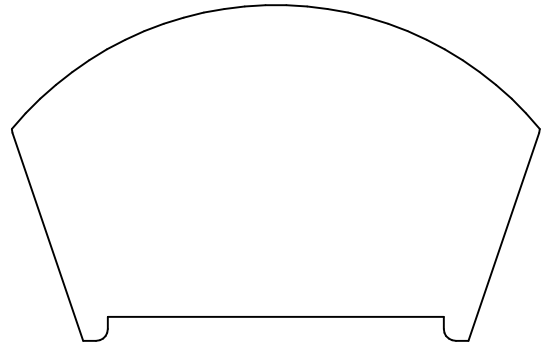

KL 5919P
1.750 x 2.750

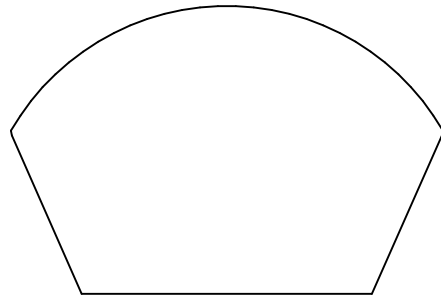

KL 5920
1.500 x 2.250

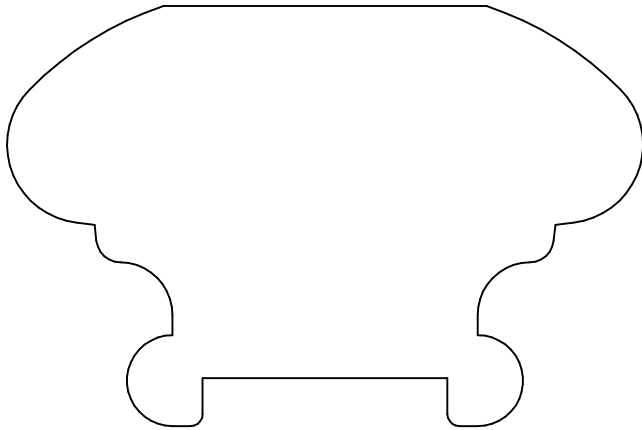

KL 5913P
2.187 x 3.312

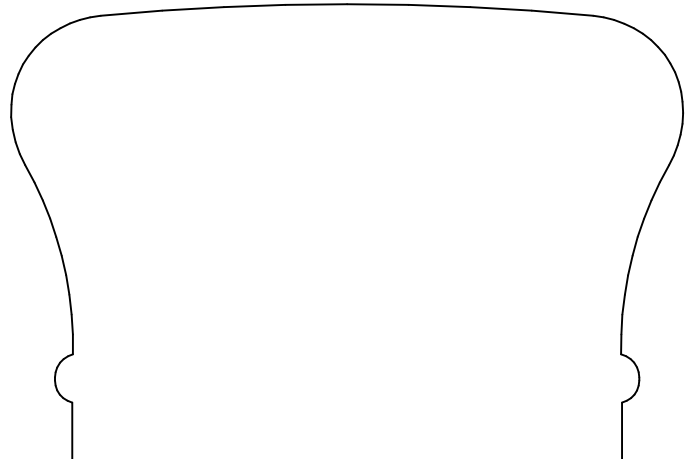

KL 5914
2.375 x 3.500

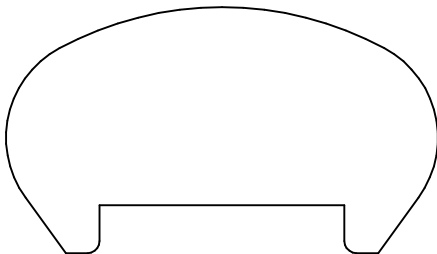

KL 5934P
1.281 x 2.250

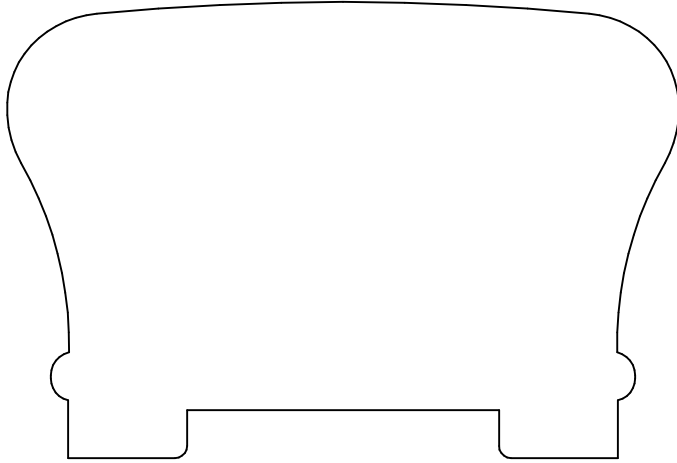

KL 5914P
2.375 x 3.500

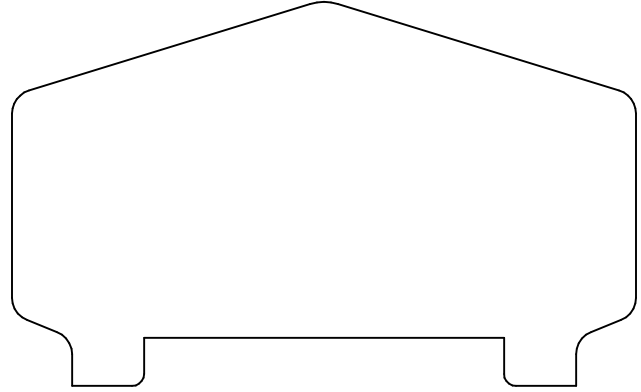

KL 5922P
2.000 x 3.250

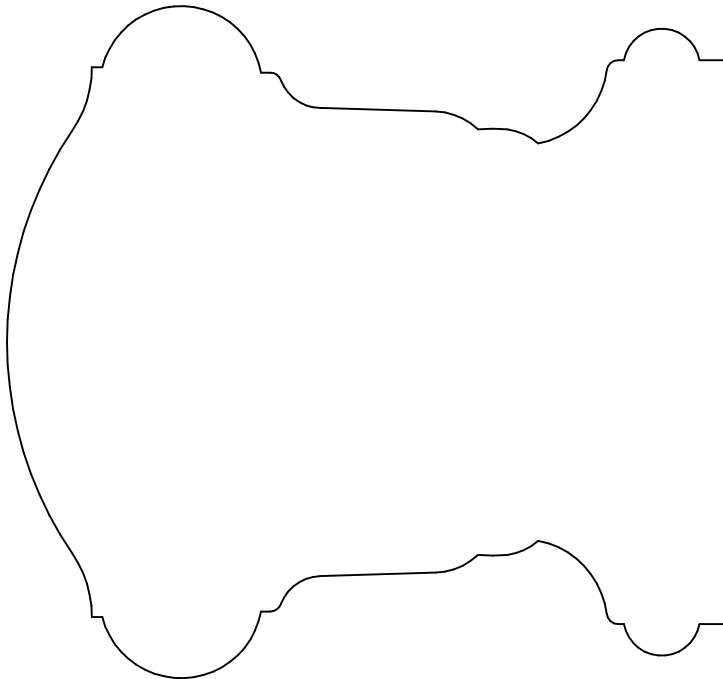

KL 5918
3.750 x 3.500

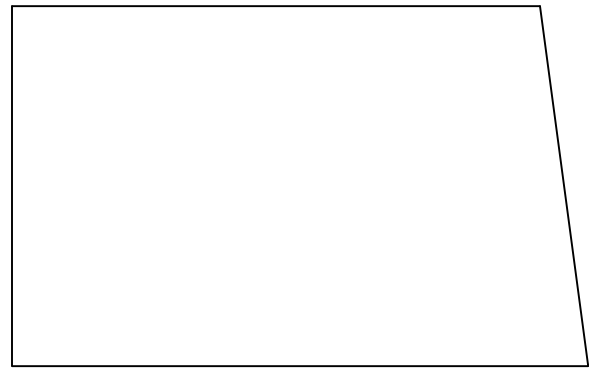

KL 5923
1.875 x 3.000

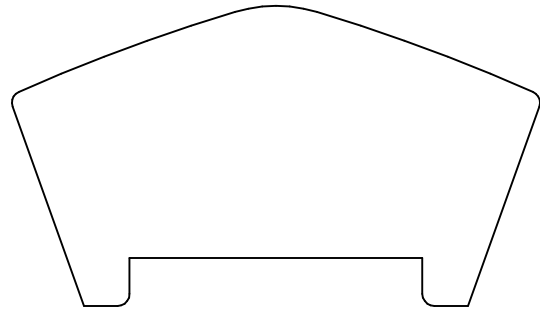

KL 5924P
1.563 x 2.750

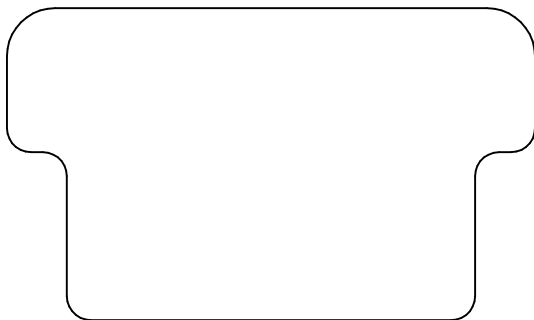

KL 5927
1.625 x 2.750

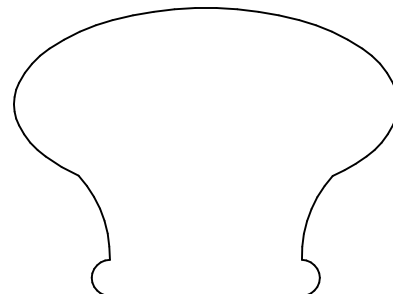

KL 5928
1.500 x 2.000

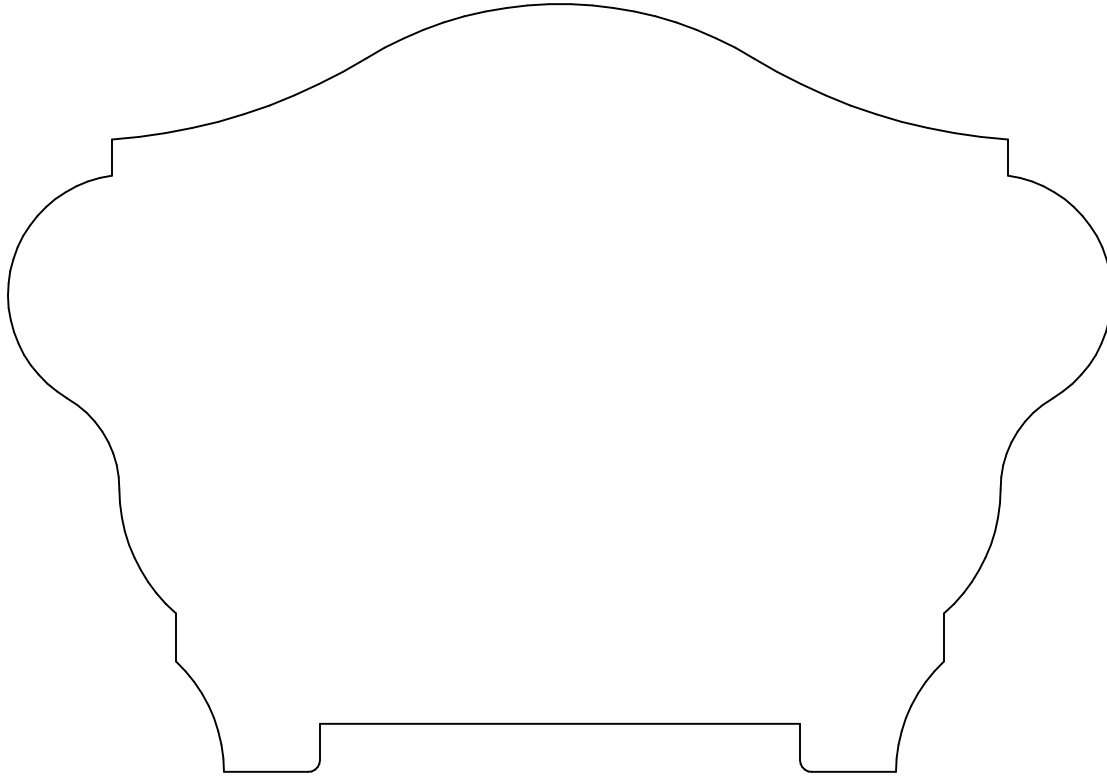

KL 5921P
4.000 x 5.750

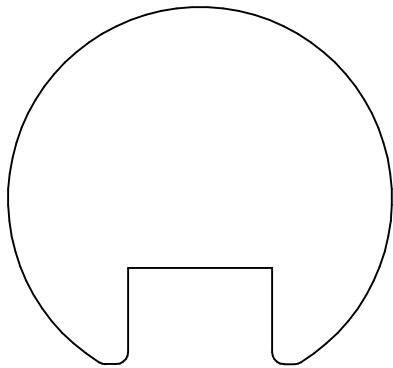

KL 5925P
1.860 x 2.000

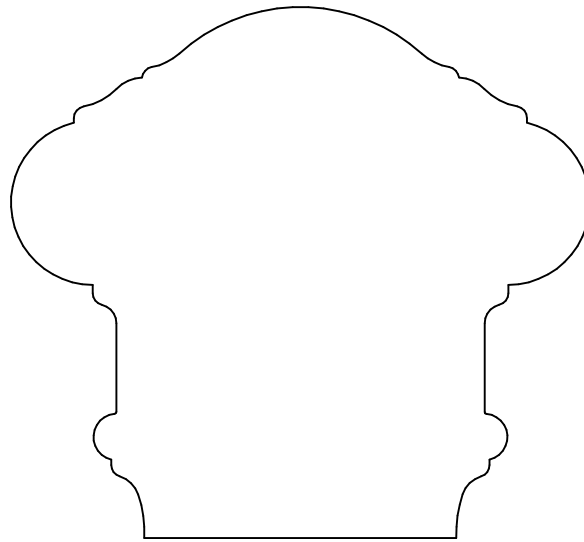

KL 5926
2.765 x 3.015

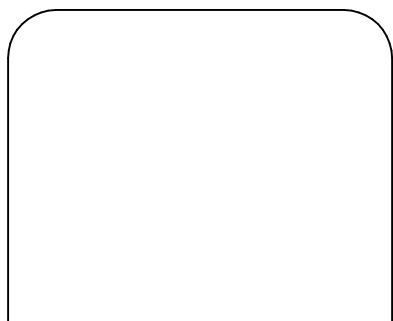

KL 5935
1.625 x 2.000

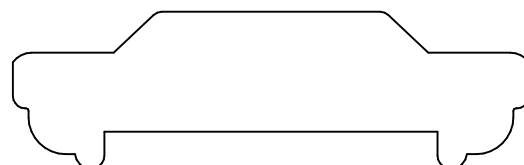

KL 5937P
.812 x 2.687

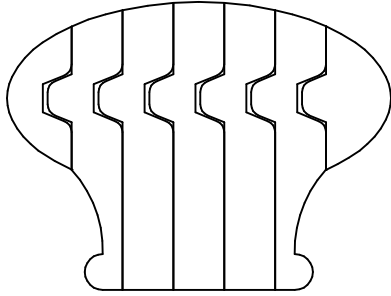

KL 5928B
1.875 x 2.000

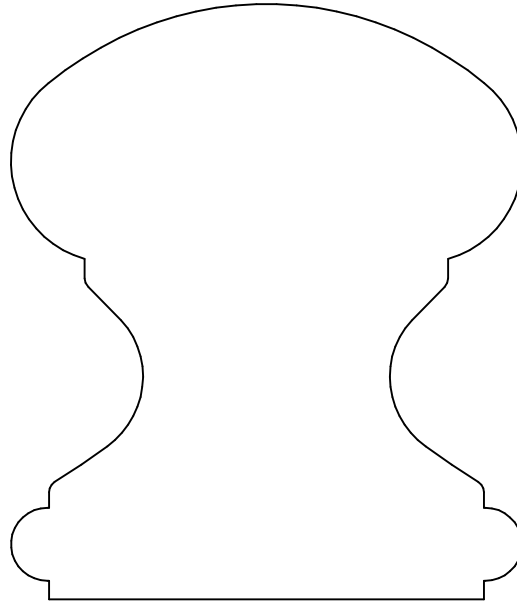

KL 5929
3.100 x 2.661

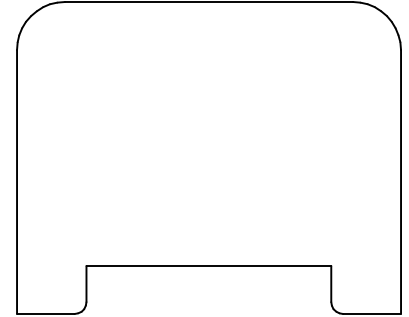

KL 5935P
1.625 x 2.000

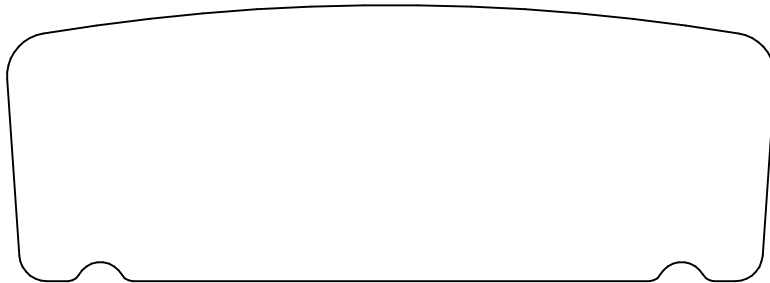

KL 5930
1.437 x 4.000

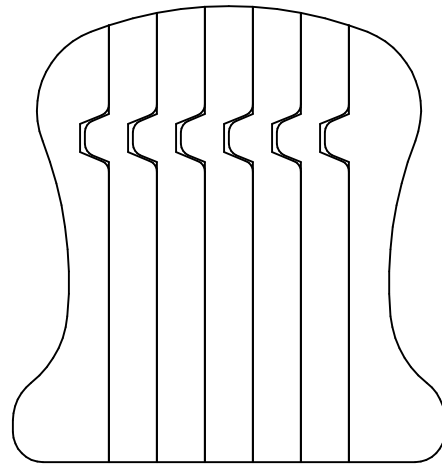

KL 5936B
1.187 x 1.125

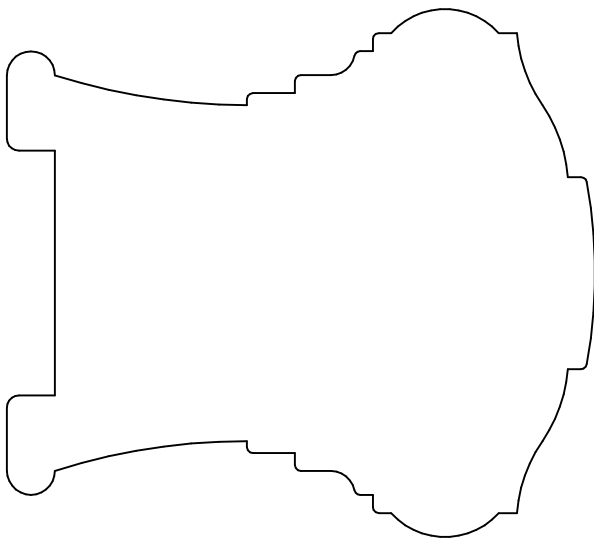

KL 5933P
3.062 x 2.750

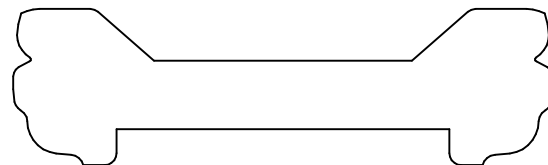

KL 5938P
.813 x 2.813

CUSTOM PROFILES

Handrail

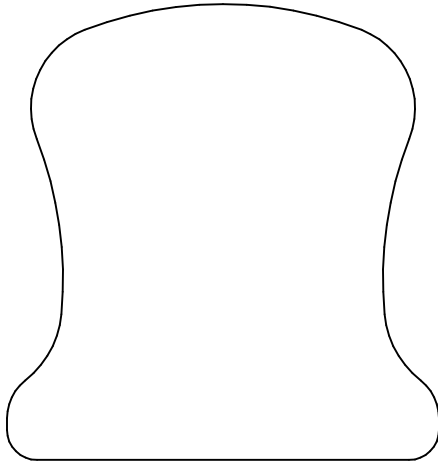

KL 5936
2.375 x 2.250

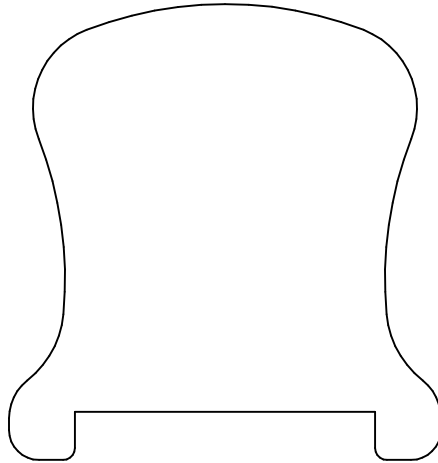

KL 5936P
2.375 x 2.250

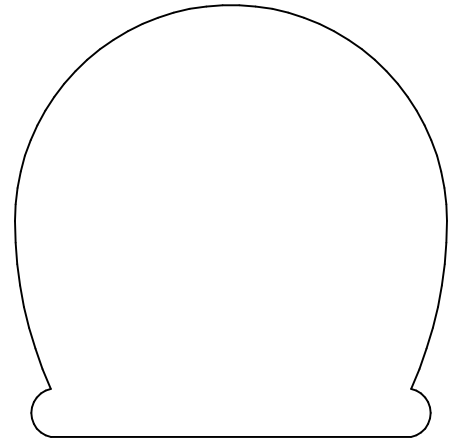

KL 5943
2.250 x 2.250

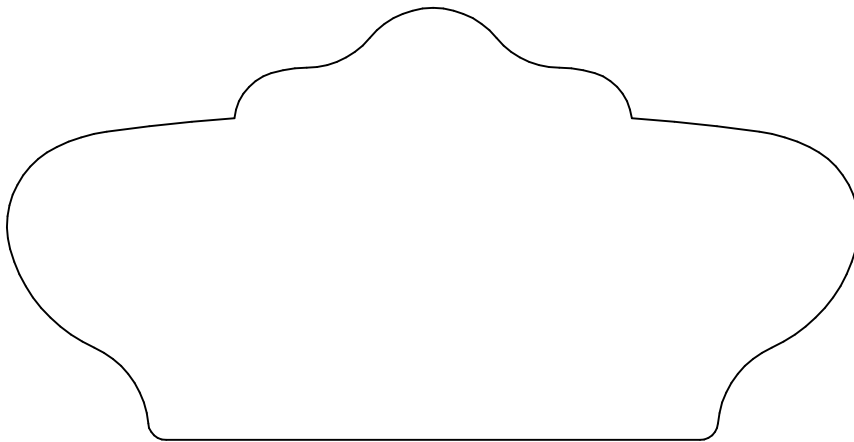

KL 5939
2.250 x 4.438

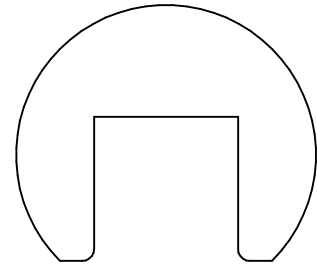

KL 5946P
1.333 x 1.562

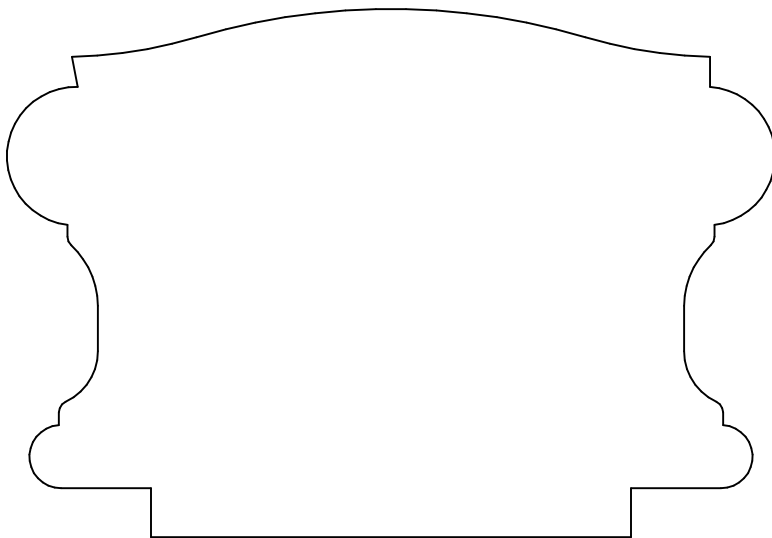

KL 5940
2.750 x 4.000

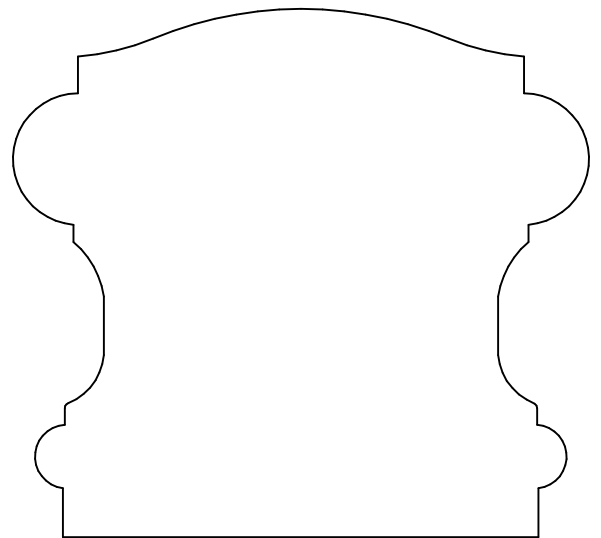

KL 5952P
2.750 x 3.000

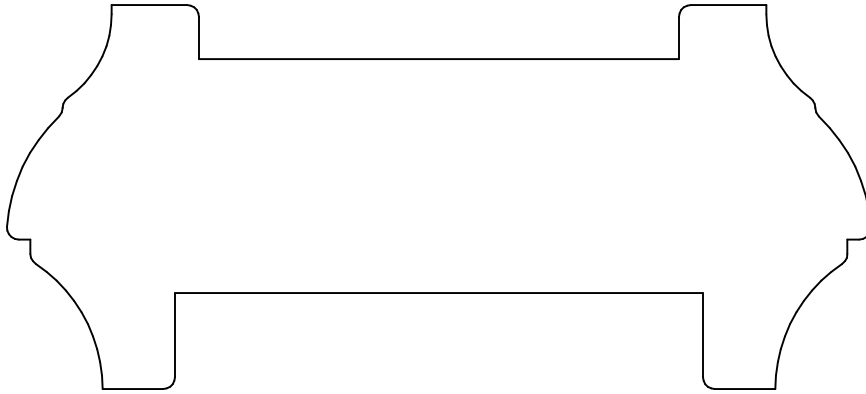

KL 5941P
2.000 x 4.500

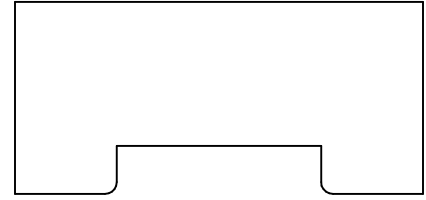

KL5949P
1.000 x 2.125

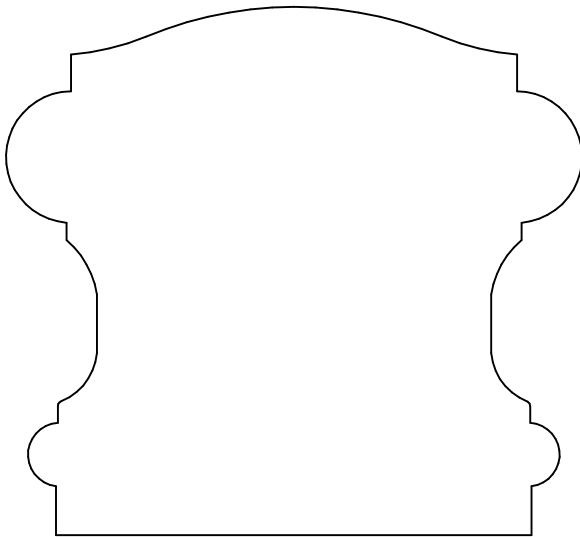

KL 5942
2.750 x 3.000

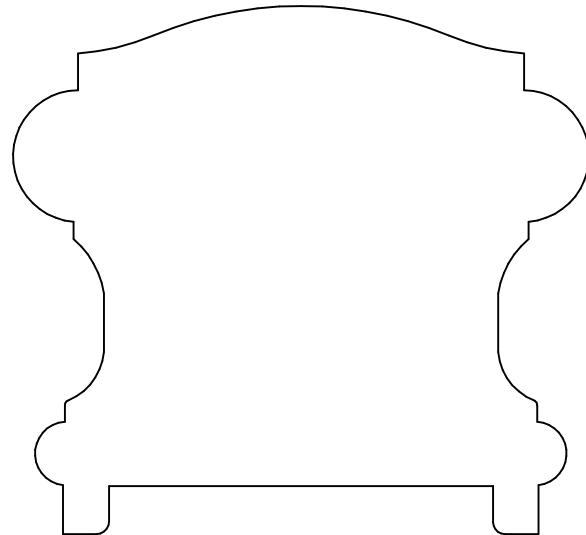

KL 5942P
2.750 x 3.000

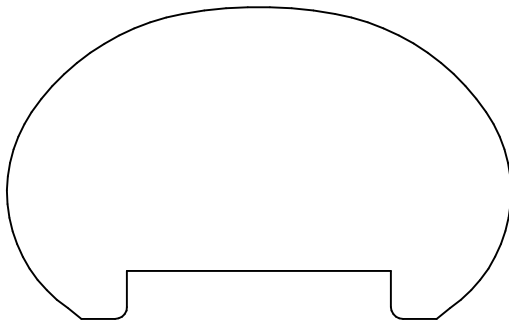

KL 5945P
1.625 x 2.625

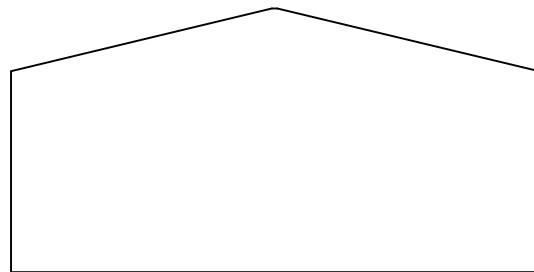

KL 5948
1.375 x 2.750

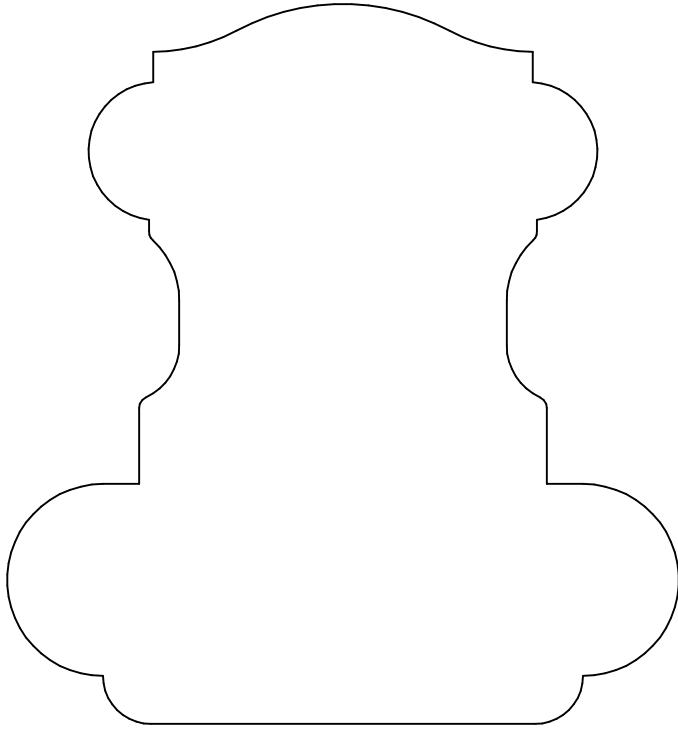

KL 5944
3.750 x 3.500

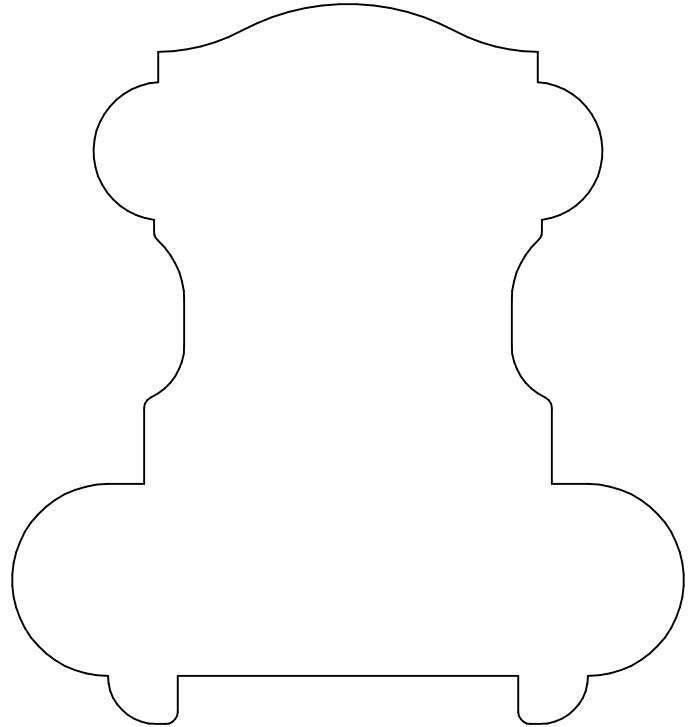

KL 5944P
3.750 x 3.500

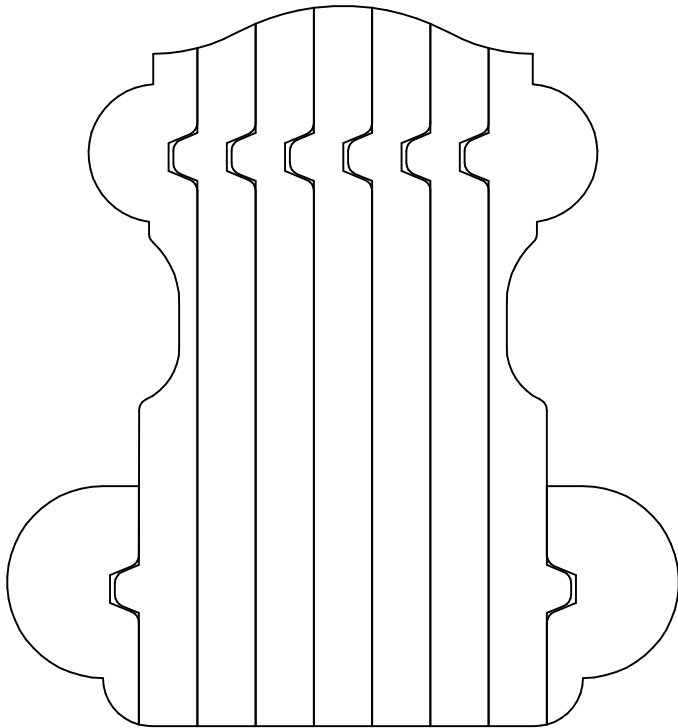

KL 5944B
3.750 x 3.500

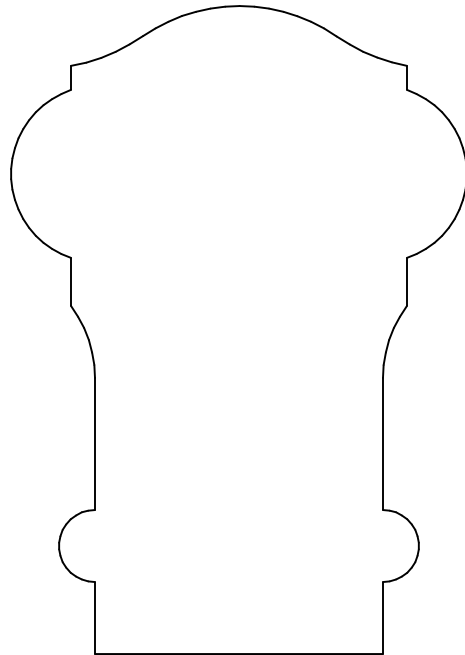

KL 5950
3.375 x 2.375

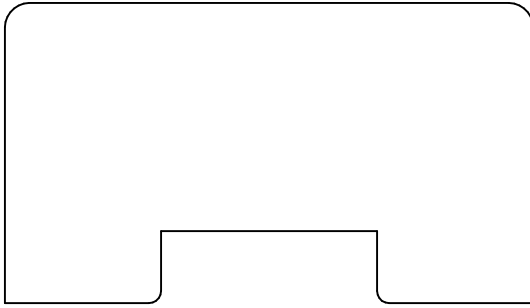

KL 5951P
1.563 x 2.750



KL 5952P
1.562 x 2.750

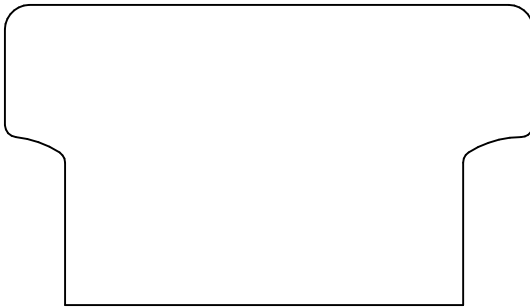

KL 5953
1.562 x 2.750

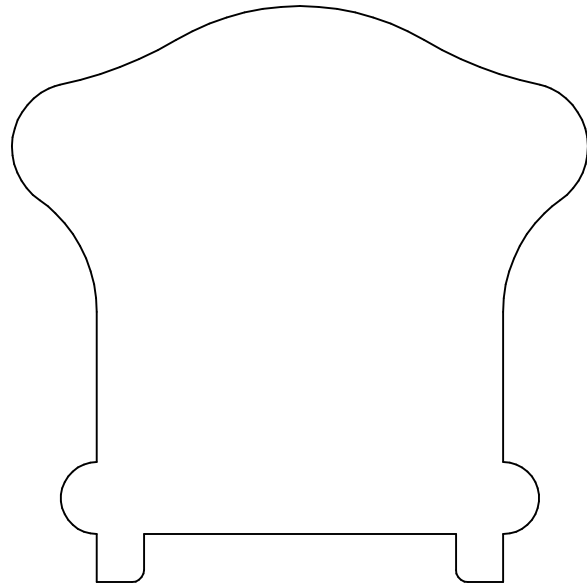

KL 5954P
3.000 x 3.000

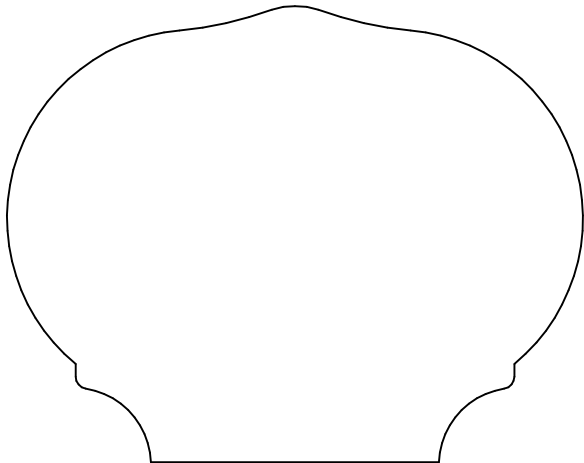

KL 5955
2.375 x 3.000

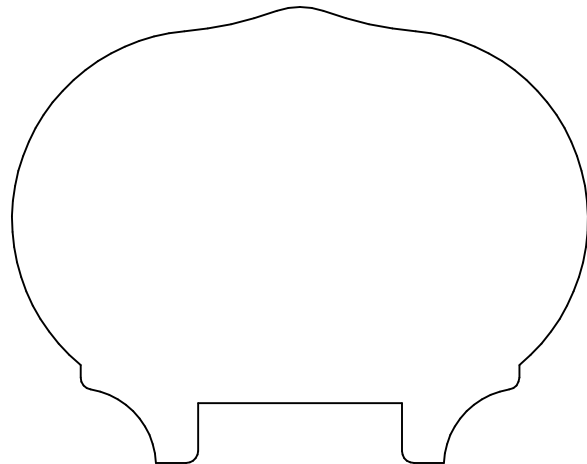

KL 5955P
2.375 x 3.000

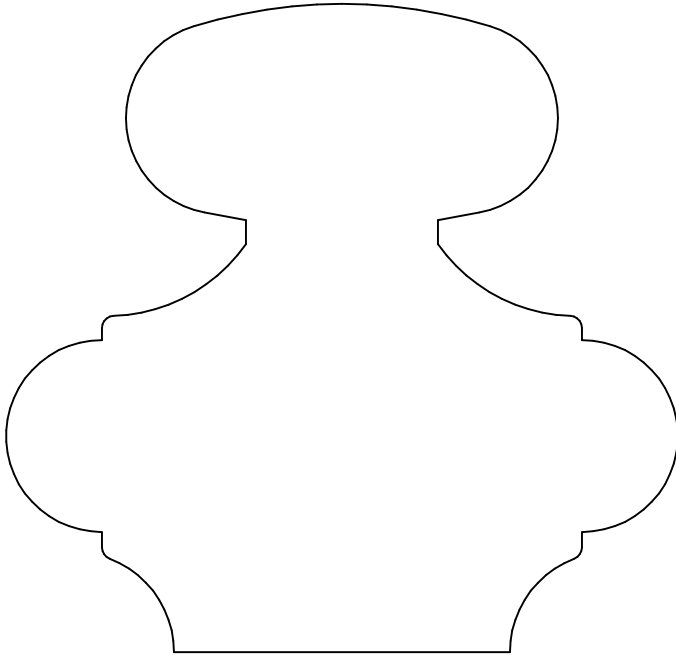

KL 5956
3.375 x 3.500

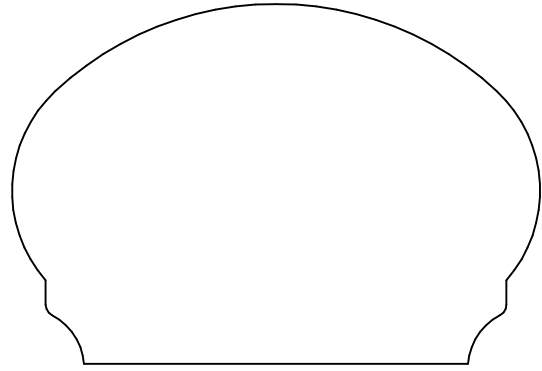

KL 5957
1.875 x 2.750

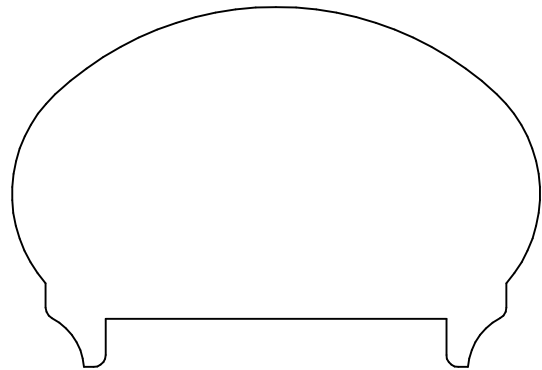

KL 5957P
1.875 x 2.750

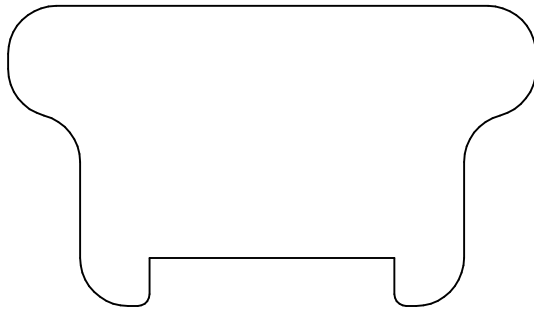

KL 5958P
1.563 x 2.750

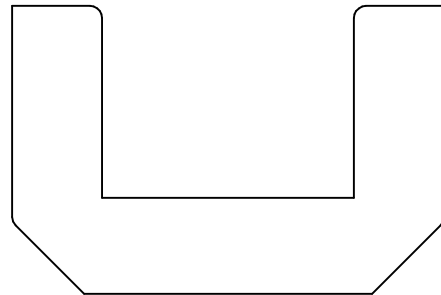

KL 5959P
1.500 x 2.250

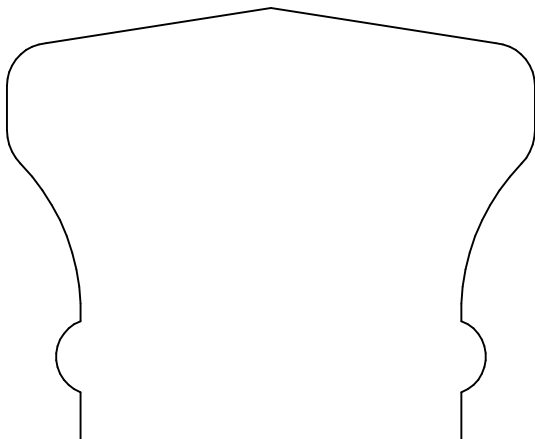

KL 5960
2.250 x 2.750

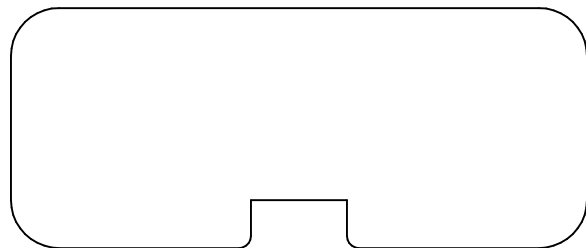

KL 5962P
1.250 x 3.000

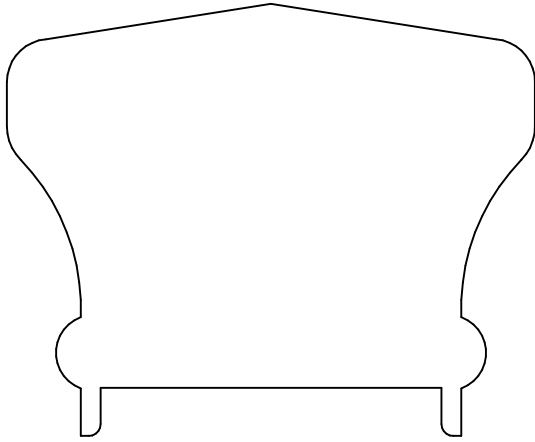

KL 5960P
2.250 x 2.750

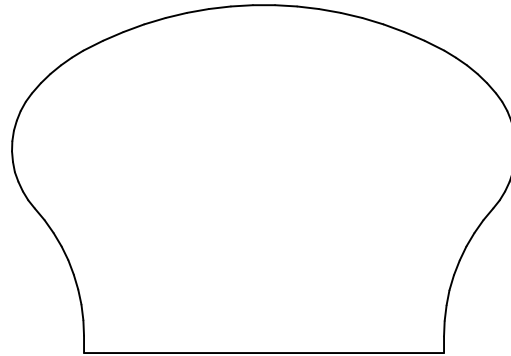

KL 5965
1.813 x 2.625

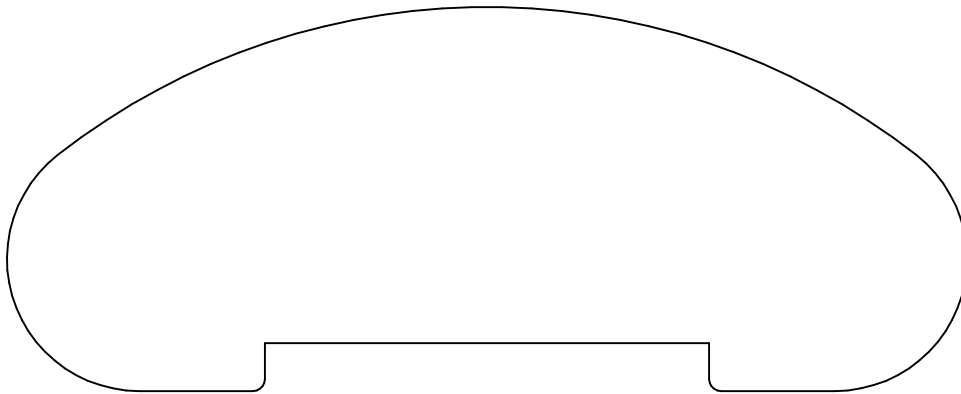

KL 5961P
2.000 x 5.000

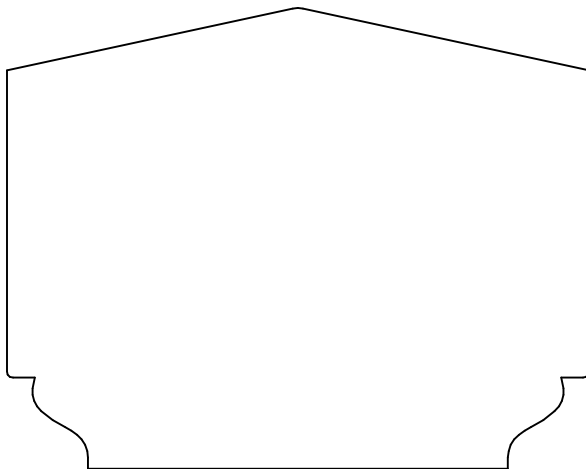

KL 5963
2.400 x 3.031

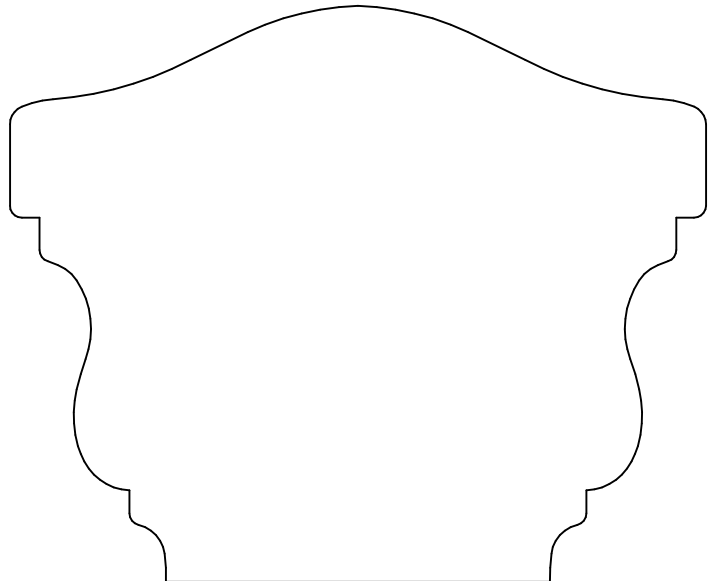

KL 5964
3.000 x 3.625



KL 5966
2.000 x 5.500

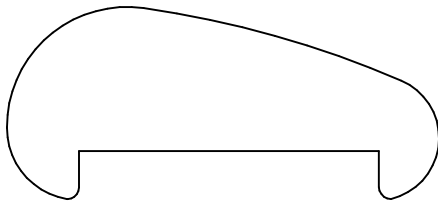

KL 5967P
1.000 x 2.250

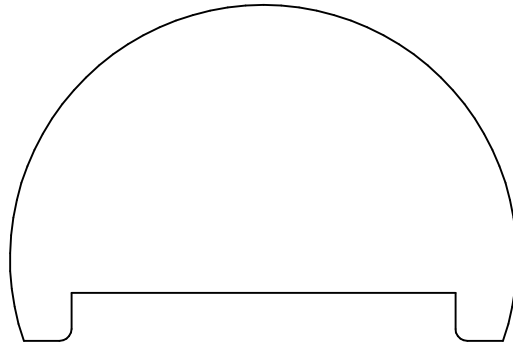

KL 5968P
1.750 x 2.640

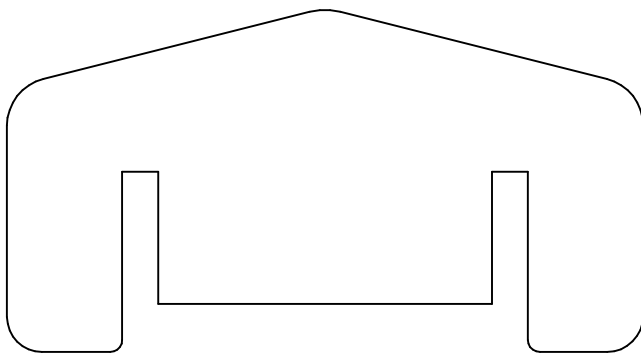

KL 5969P
1.781 x 3.313

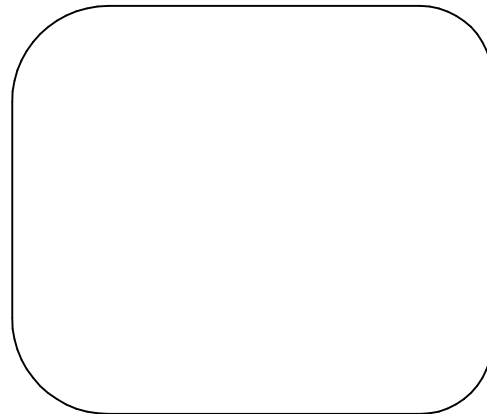

KL 5971
2.125 x 2.500

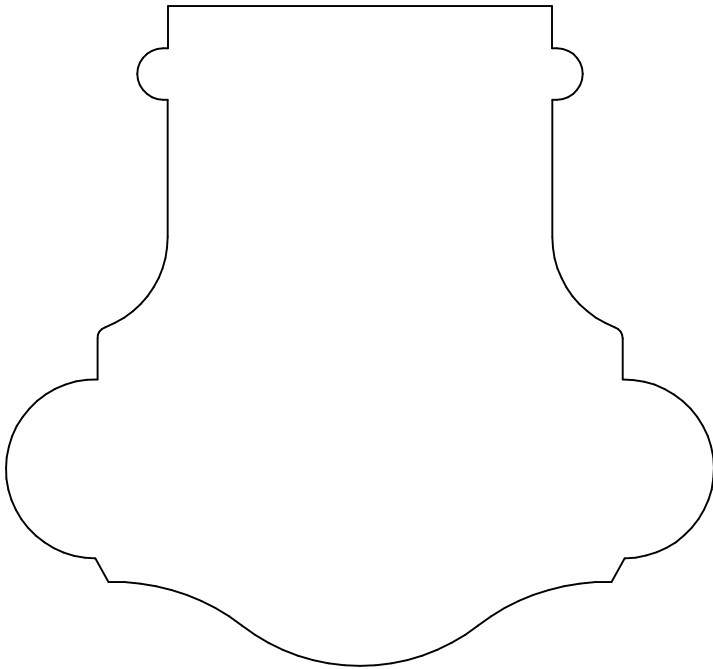

KL 5970
3.437 x 3.688

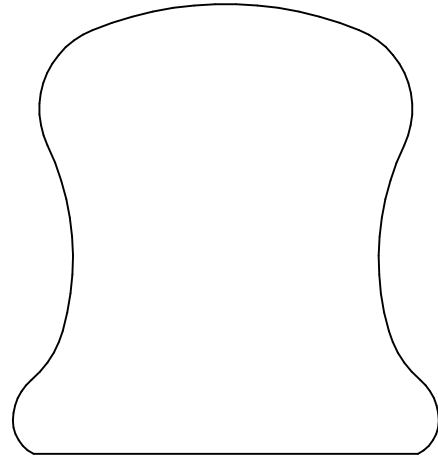

KL 5973
2.343 x 2.218

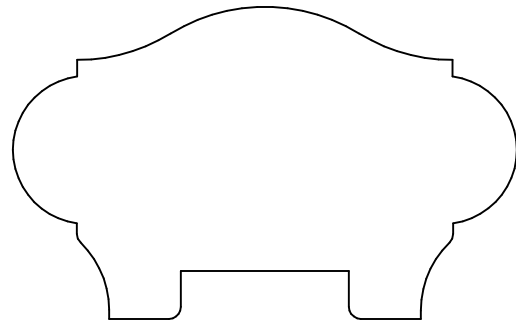

KL 5974P
1.625 x 2.625

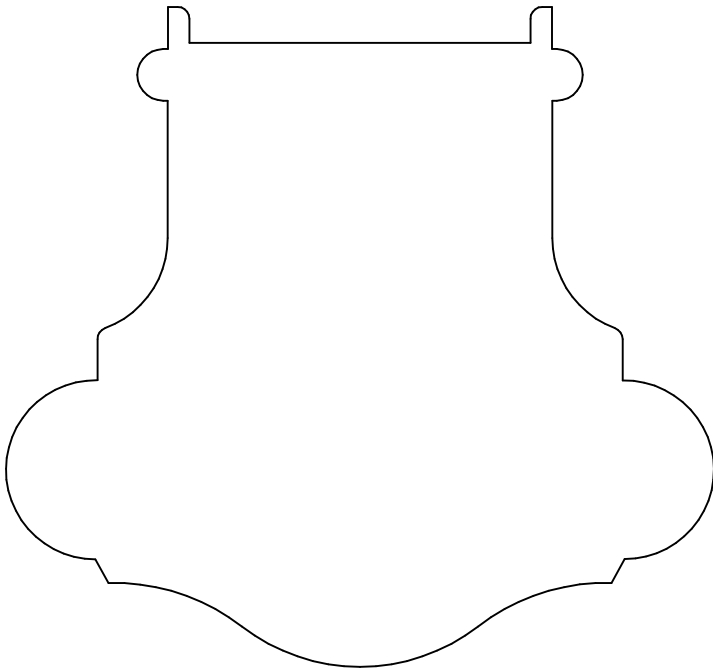

KL 5970P
3.437 x 3.688

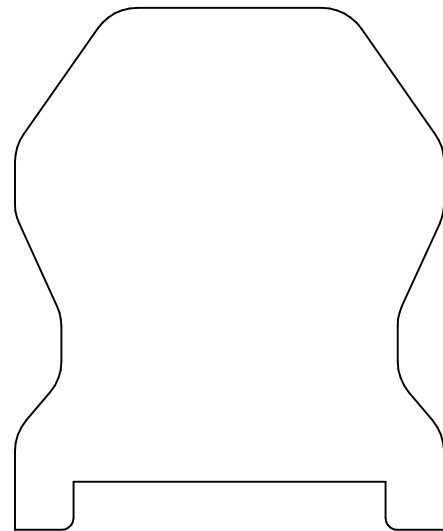

KL 5975P
2.719 x 2.234

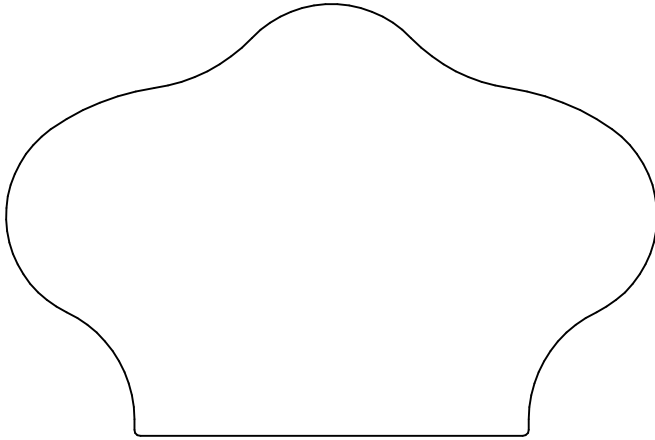

KL 5972
2.250 x 3.391

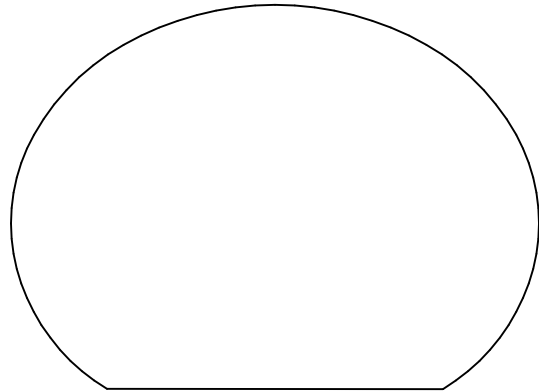

KL 5988
2.000 x 2.750

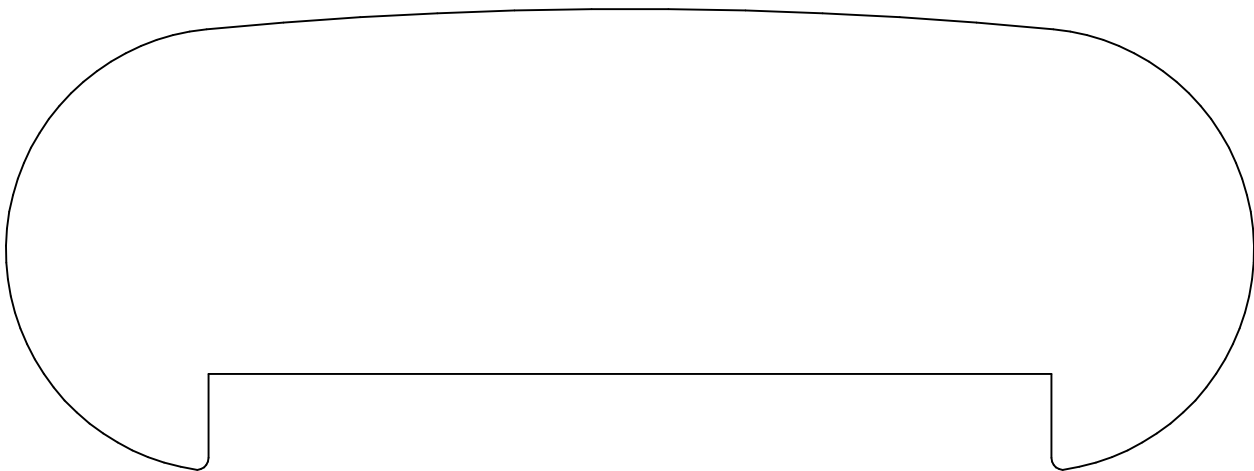

KL 5976P
2.400 x 6.500

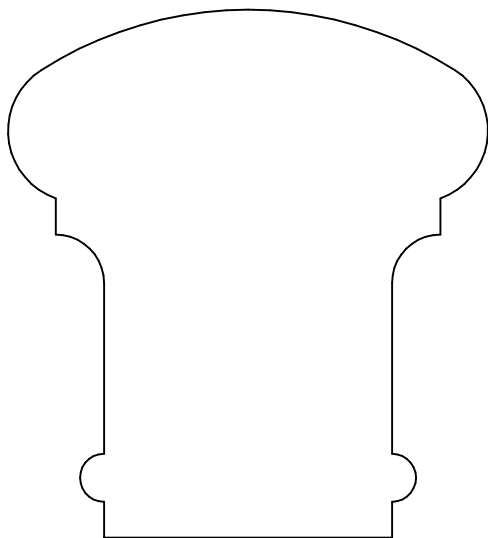

KL 5977
2.750 x 2.500

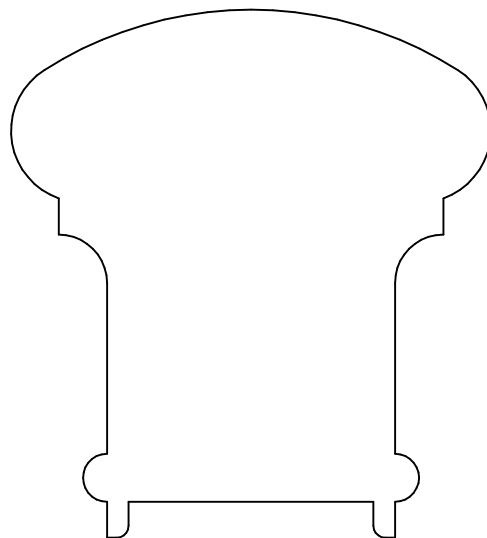

KL 5977P
2.750 x 2.500

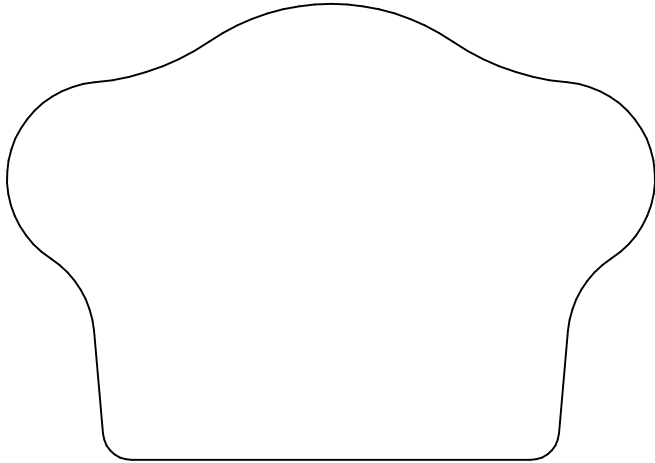

KL 5978
2.375 x 3.375

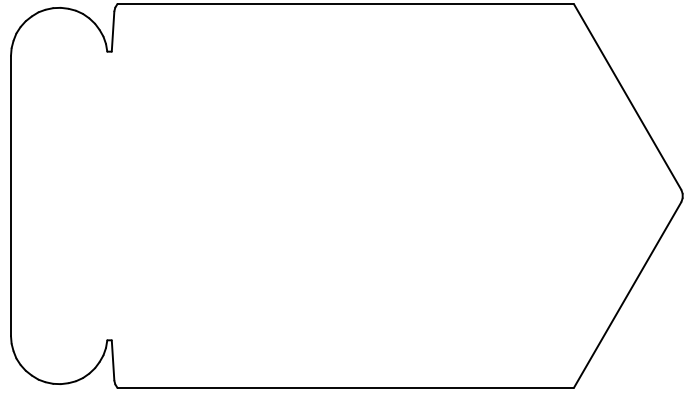

KL 5980
2.000 x 3.500

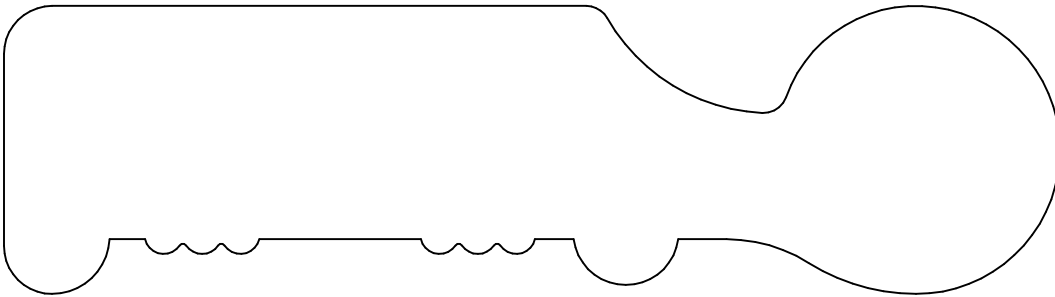

KL 5979
1.500 x 5.500

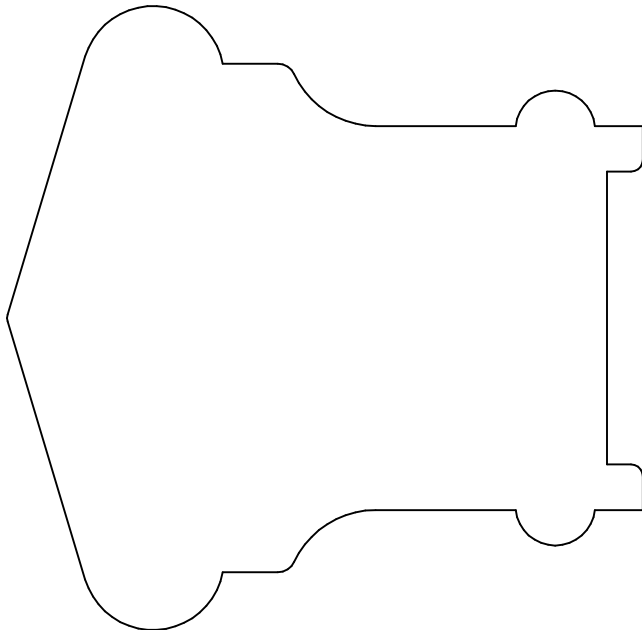

KL 5981P
3.312 x 3.250

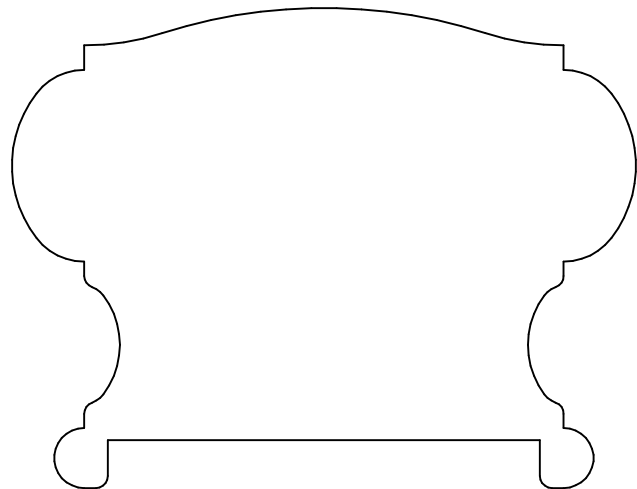

KL 5983P
2.500 x 3.250

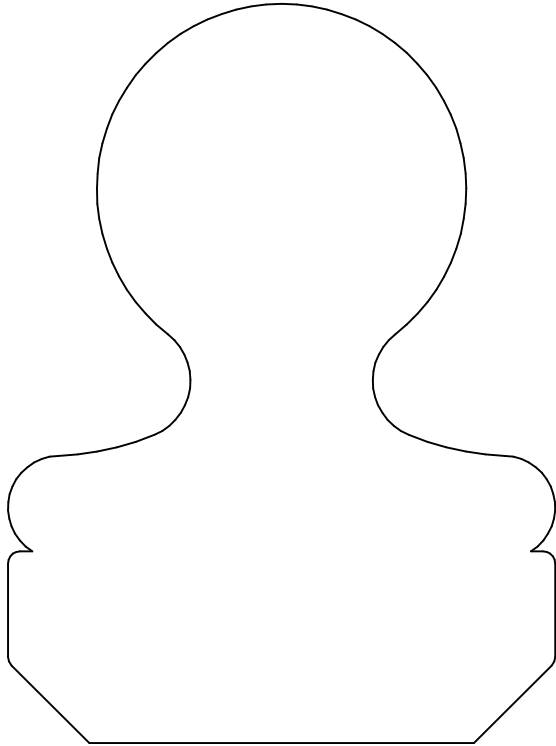

KL 5982
3.850 x 2.850

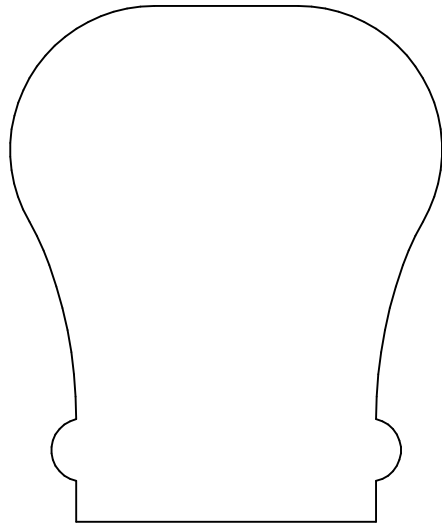

KL 5984
2.687 x 2.250

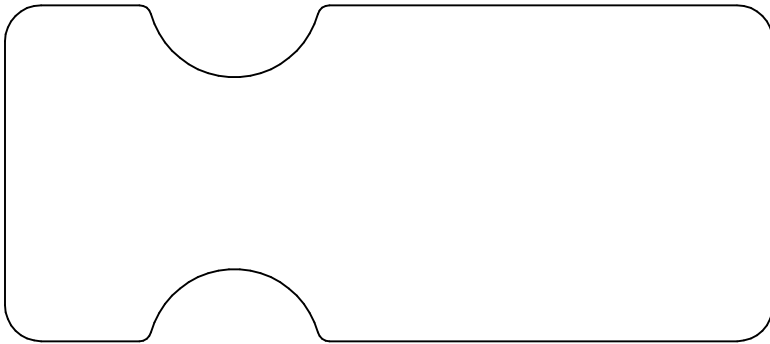

KL 5985
1.750 x 4.000

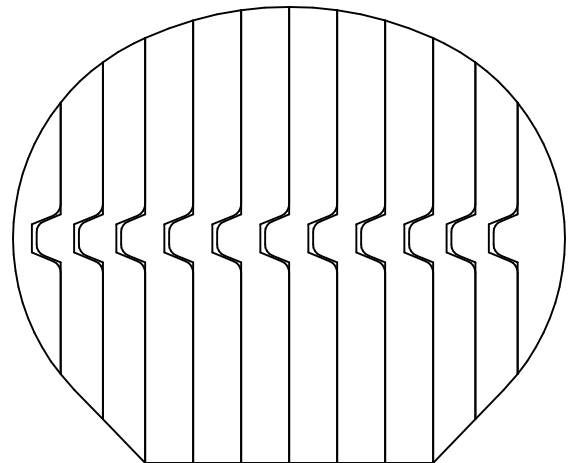

KL 5986B
2.500 x 3.500

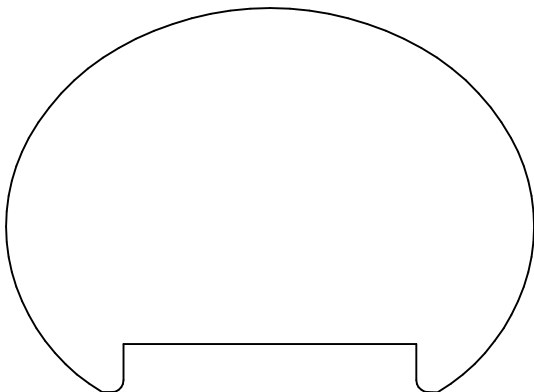

KL 5988P
2.000 x 2.750

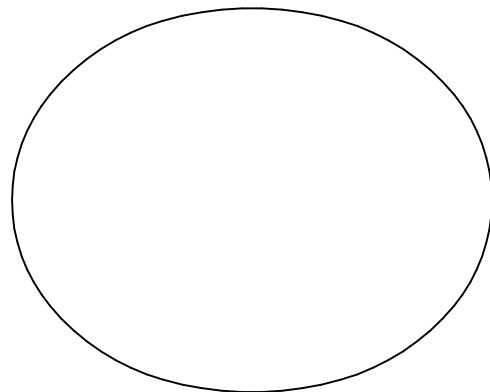

KL 5990
2.000 x 2.500

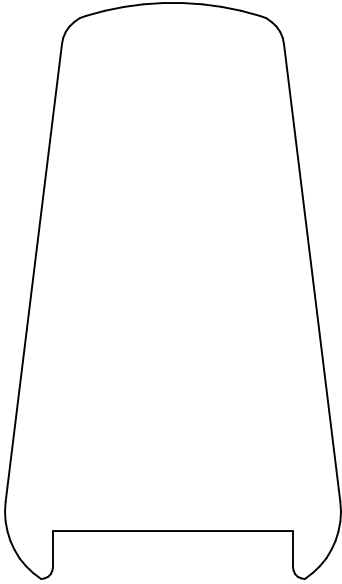

KL 5987P
3.000 x 1.750

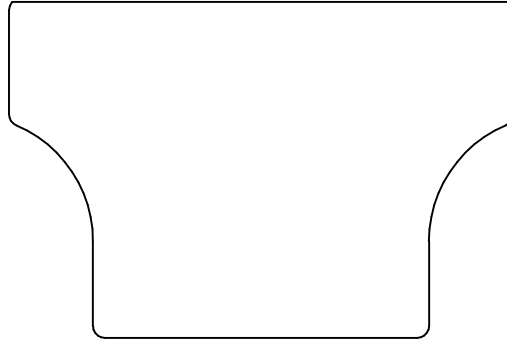

KL 5991
1.750 x 2.625

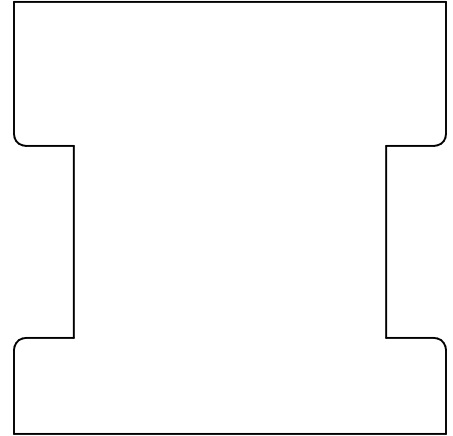

KL 5993
2.250 x 2.250



KL 5989
1.500 x 5.500

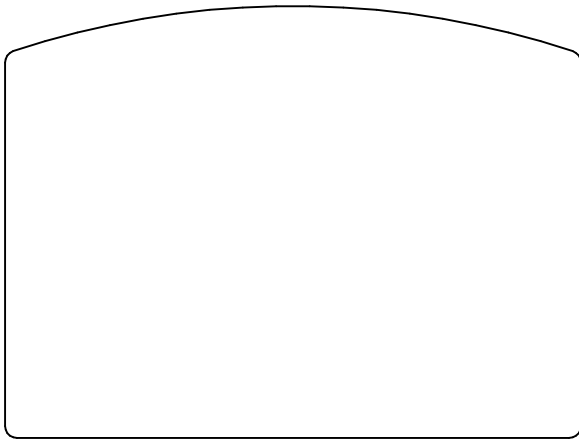

KL 5992
2.250 x 3.000

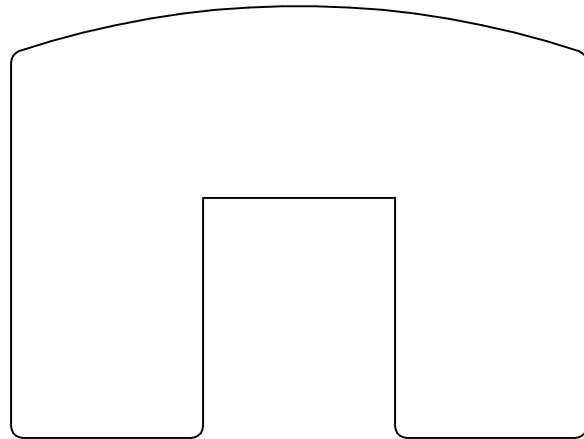

KL 5992P
2.250 x 3.000

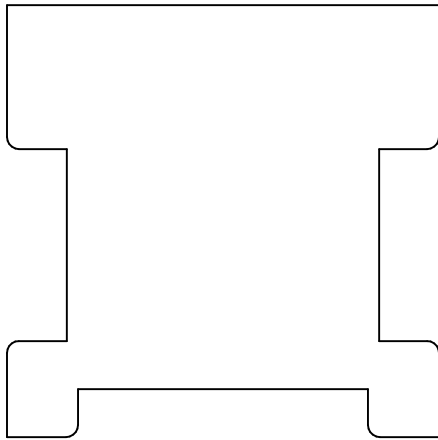

KL 5993P
2.250 x 2.250

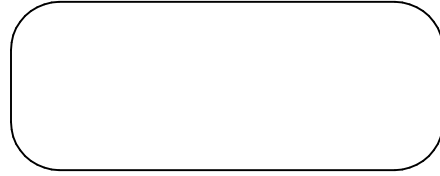

KL 5994
.875 x 2.250

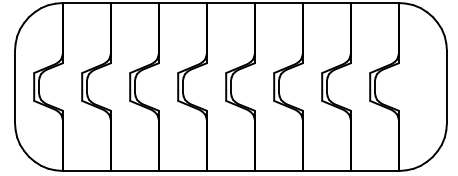

KL 5994B
.875 x 2.250

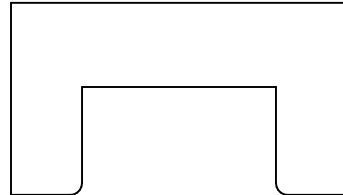

KL 5995P
1.000 x 1.750

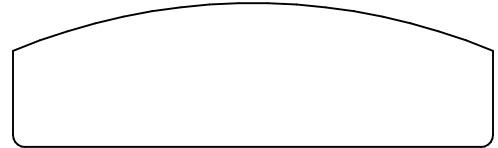

KL 5996
.750 x 2.500

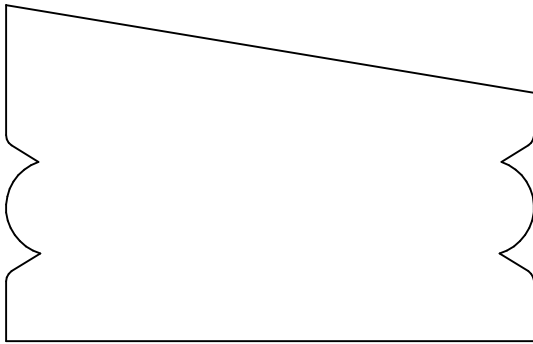

KL 5997
1.750 x 2.750

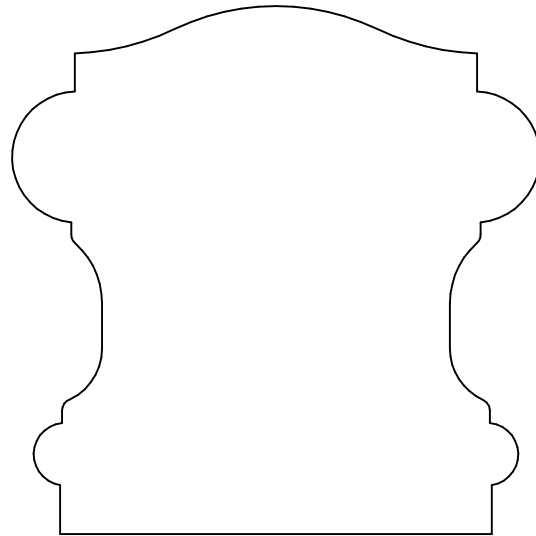

KL 5998
2.750 x 2.750

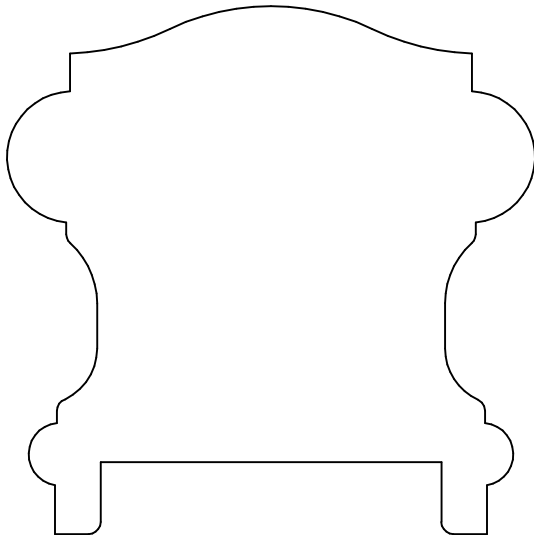

KL 5998P
2.750 x 2.750

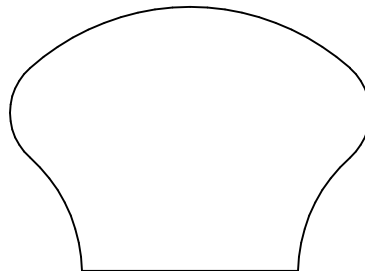

KL 5999
1.375 x 1.875



KL6903
1.000 x 2.000

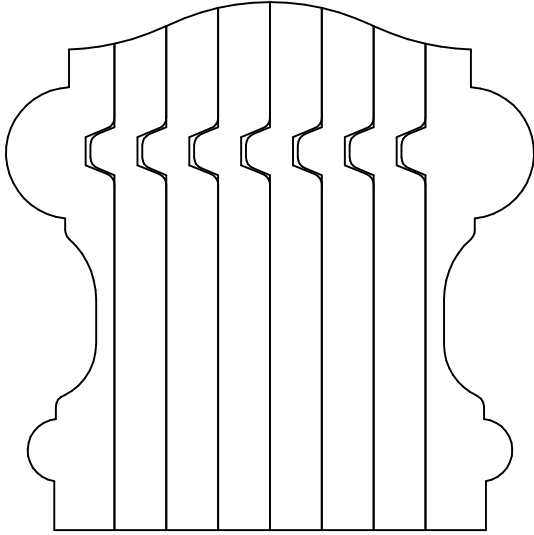

KL 5998B
2.750 x 2.750

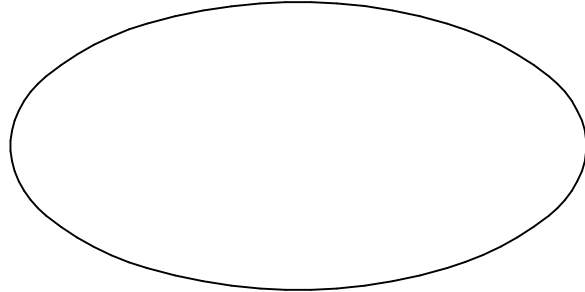

KL6900
1.500 x 3.000

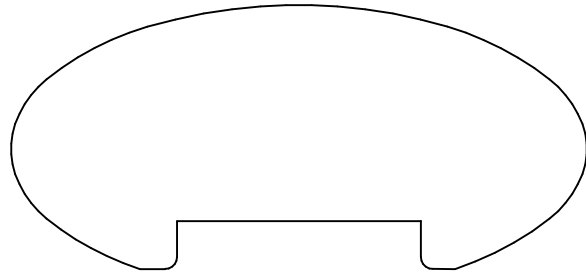

KL6900P
1.375 x 3.000

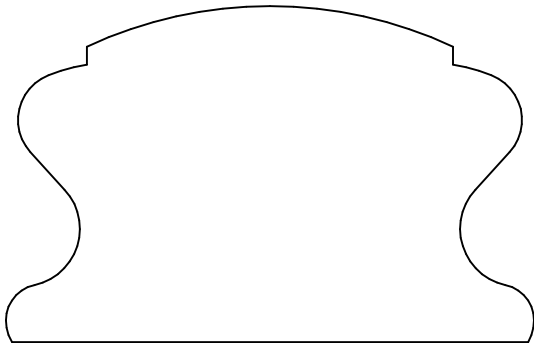

KL6901
1.750 x 2.750

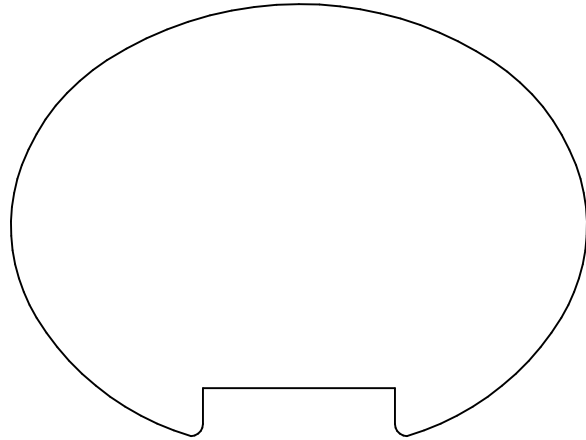

KL 6902P
2.250 x 3.000

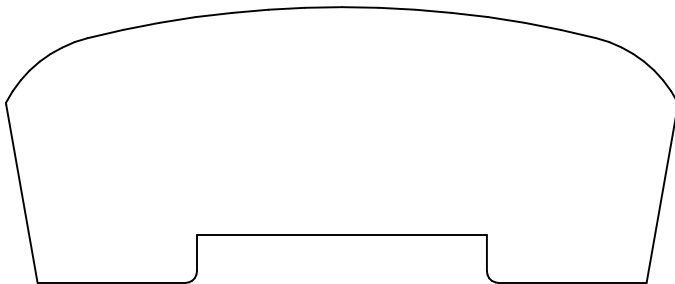

KL 6904P
1.437 x 3.500



KL 6906
1.500 x 2.750

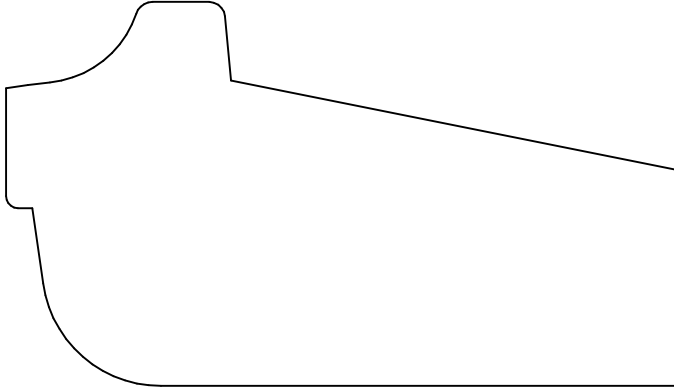

KL6905
2.000 x 3.500

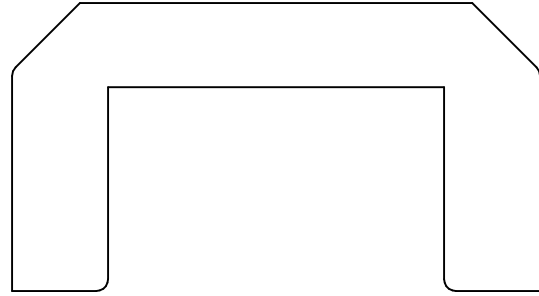

KL 6906P
1.500 x 2.750

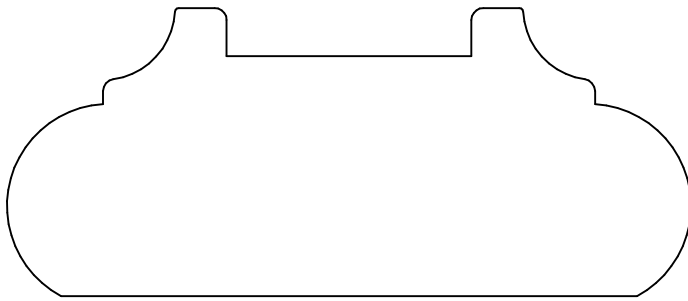

KL 6907P
1.500 x 3.563

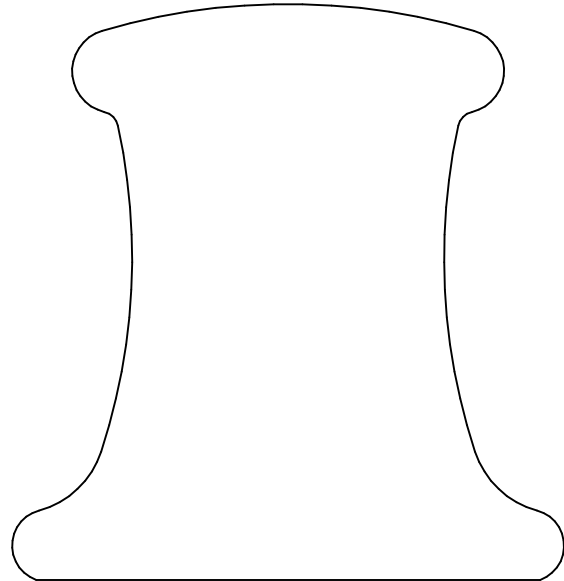

KL 6908
3.000 x 2.875

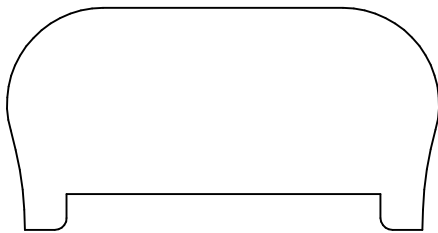

KL 6909P
1.156 x 2.250

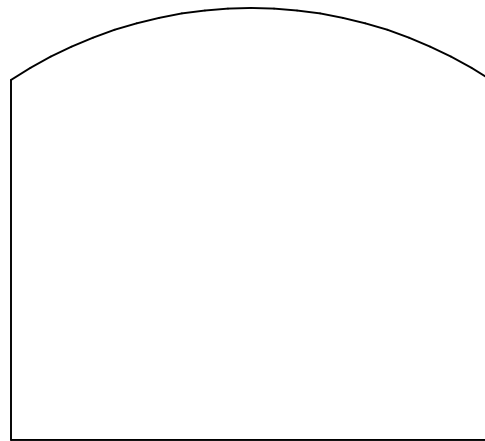

KL 6912
2.250 x 2.500

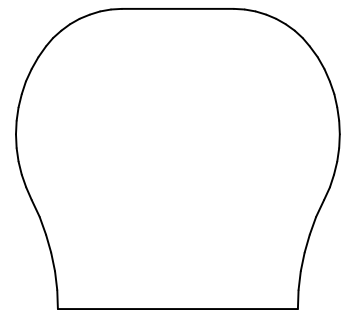

KL 6920
1.562 x 1.687

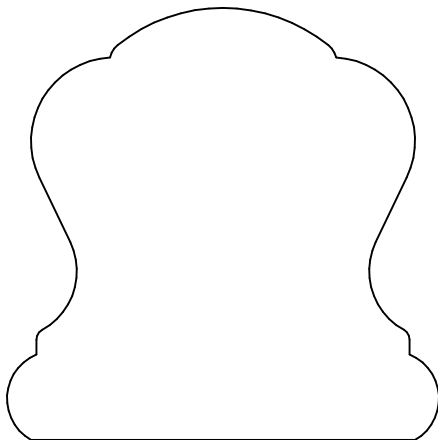

KL 6910
2.250 x 2.250

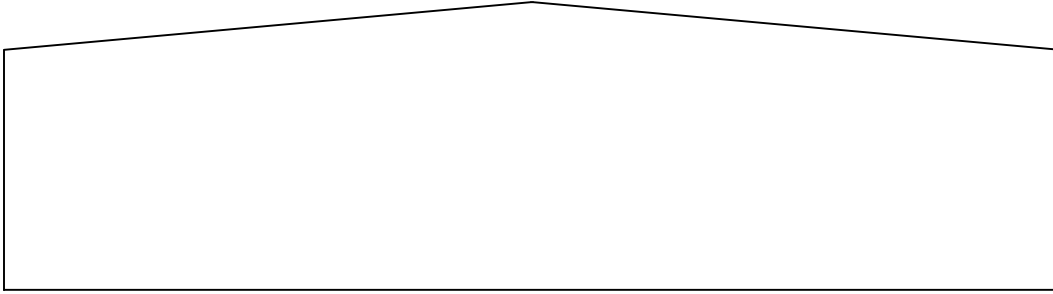

KL 6911
1.500 x 5.500

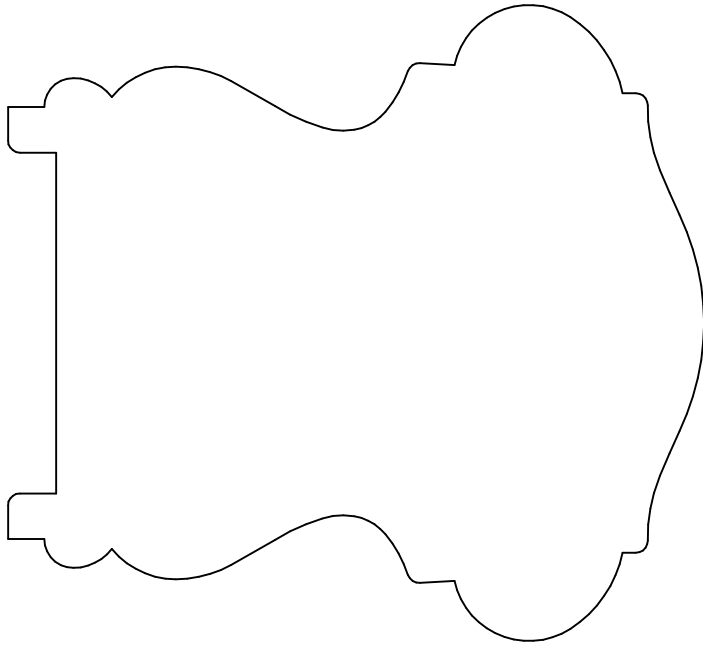

KL 6913P
3.625 x 3.313

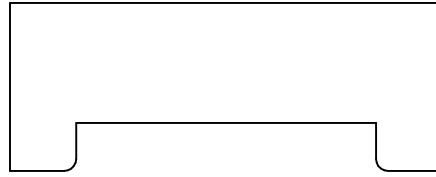

KL 6914P
.875 x 2.250

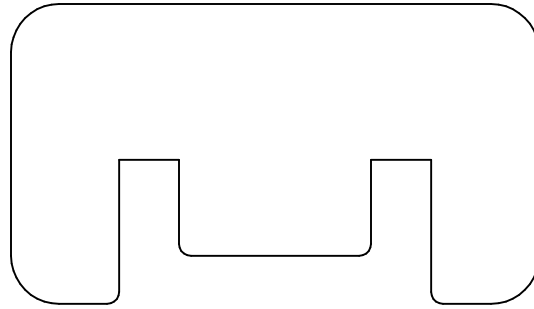

KL 6915P
1.562 x 2.750

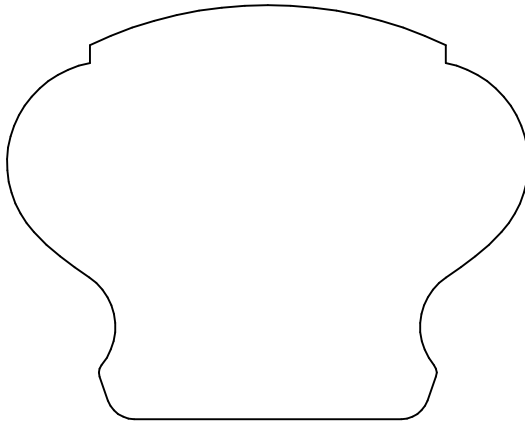

KL 6916
2.157 x 2.716

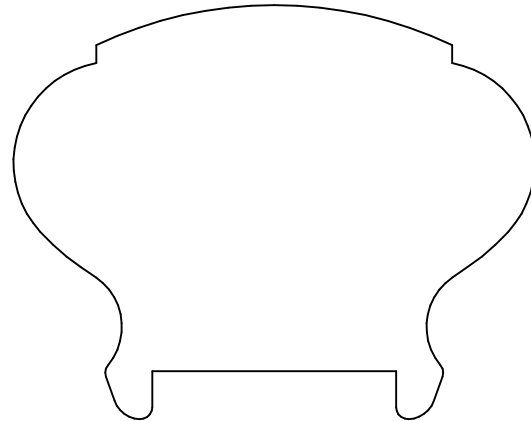

KL 6916P
2.157 x 2.716

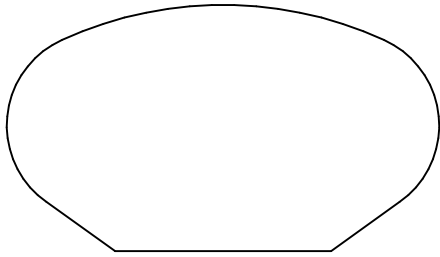

KL 6917
1.281 x 2.250

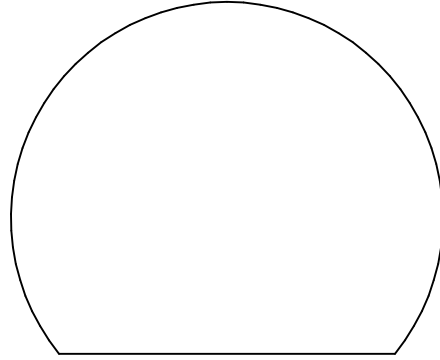

KL 6918
1.832 x 2.250

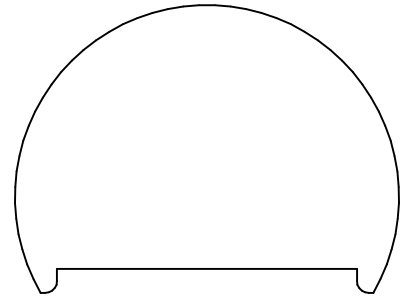

KL 6923P
1.500 x 2.000

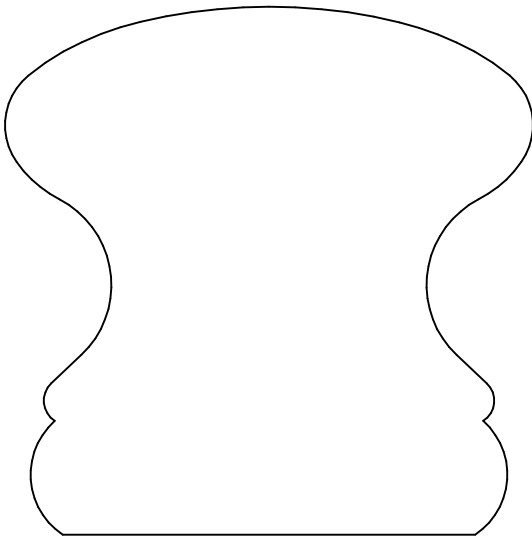

KL 6919
2.750 x 2.750

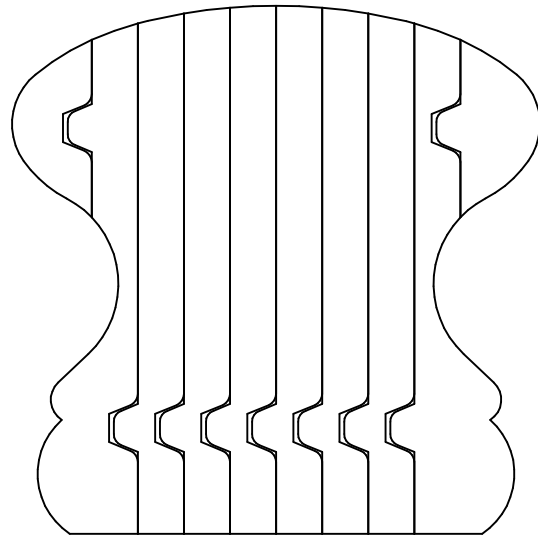

KL 6919B
2.750 x 2.750

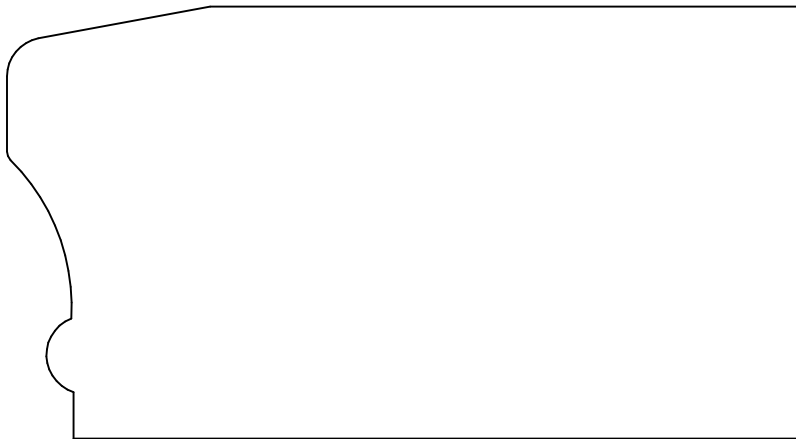

KL 6921
2.250 x 4.125

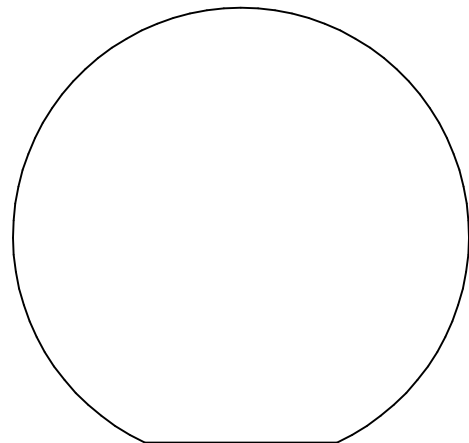

KL 6922
2.265 x 2.375

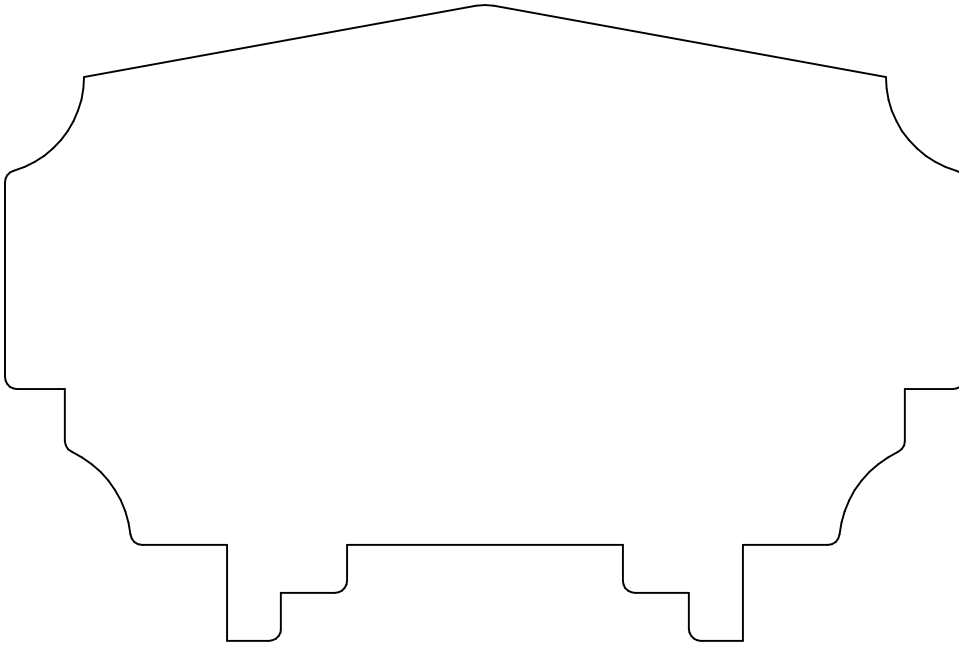

KL 6924P
3.312 x 5.000

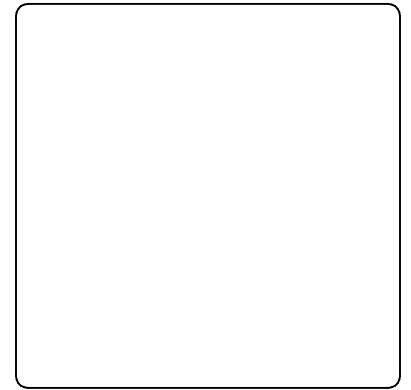

KL 6930
2.000 x 2.000

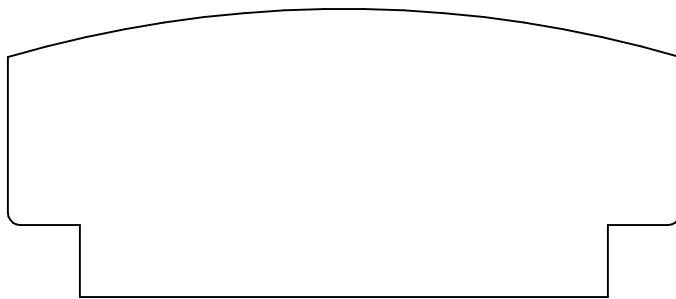

KL 6925
1.500 x 3.500

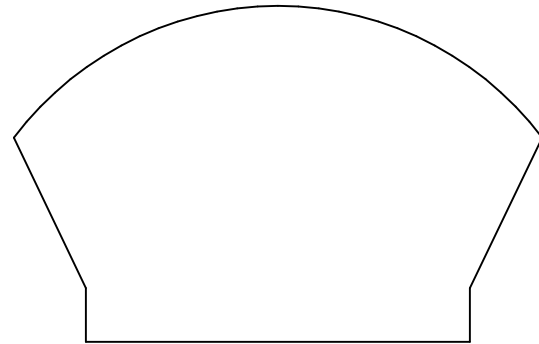

KL 6926
1.750 x 2.750

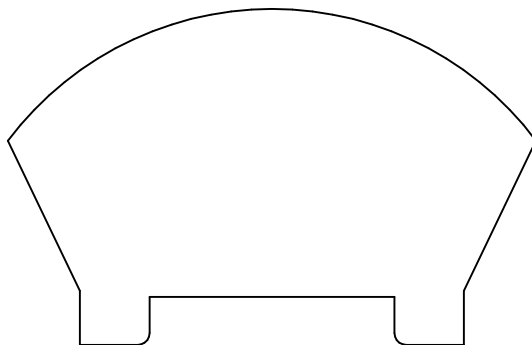

KL 6926P
1.750 x 2.750

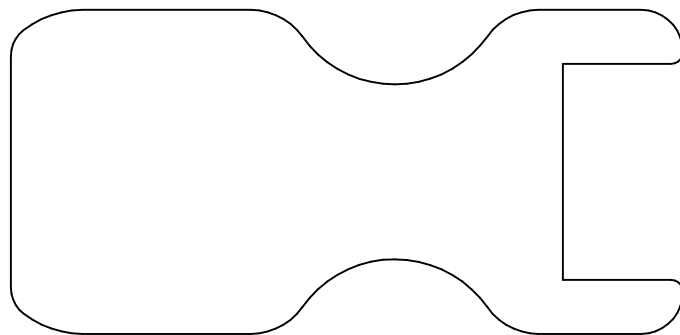

KL 6927P
1.687 x 3.500

CUSTOM PROFILES

Handrail

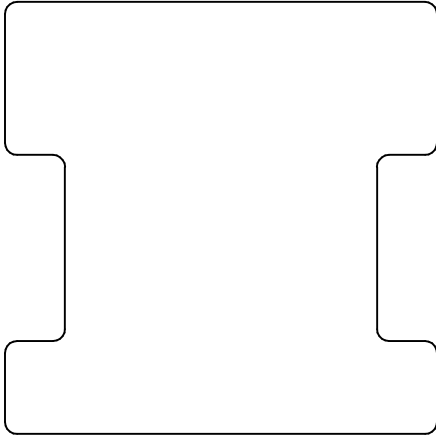

KL 6928
2.250 x 2.250

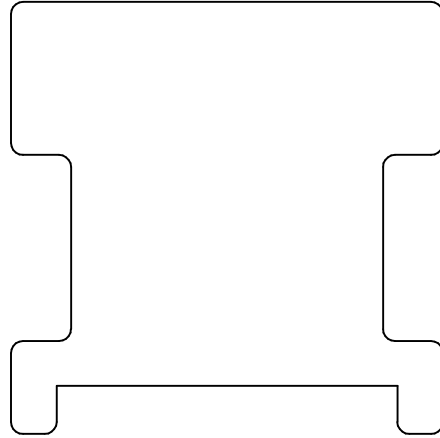

KL 6928P
2.250 x 2.250

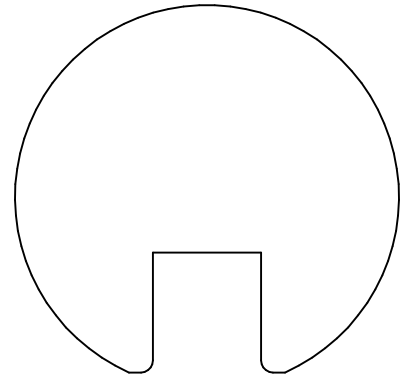

KL 6946P
1.914 x 2.000

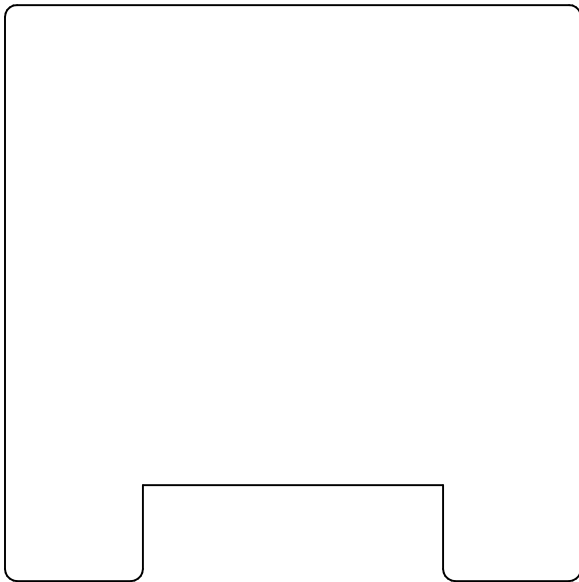

KL 6929P
3.000 x 3.000

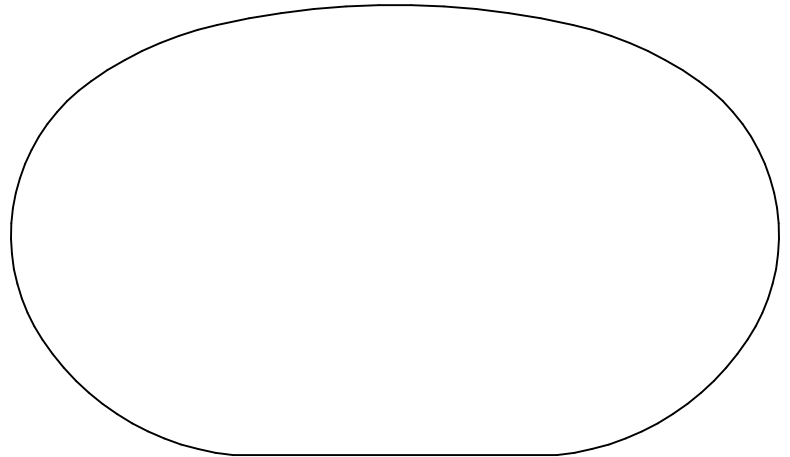

KL 6931
2.344 x 4.000

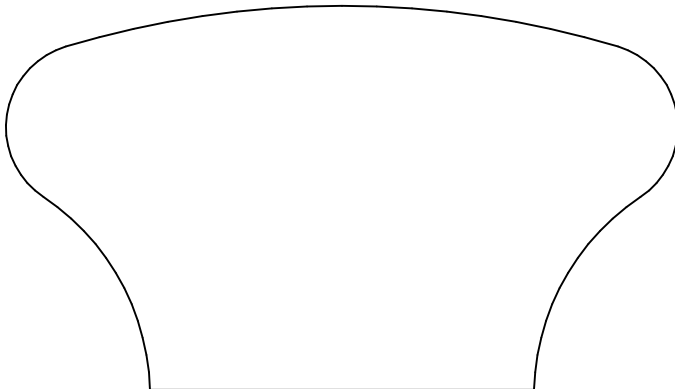

KL 6932
2.000 x 3.500

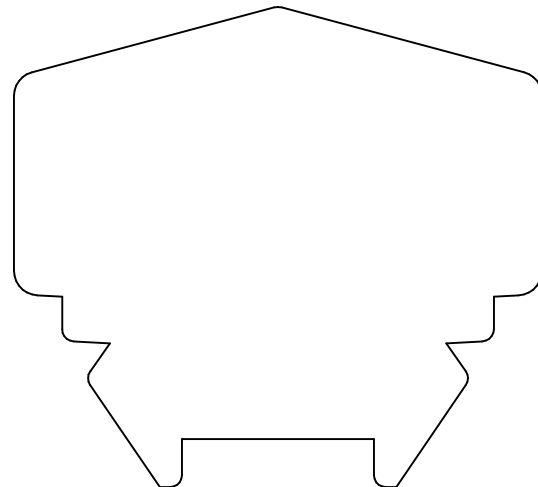

KL 6933P
2.500 x 2.750

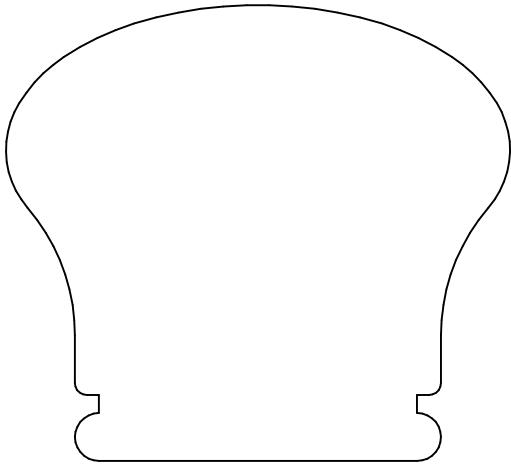

KL 6934
2.375 x 2.625

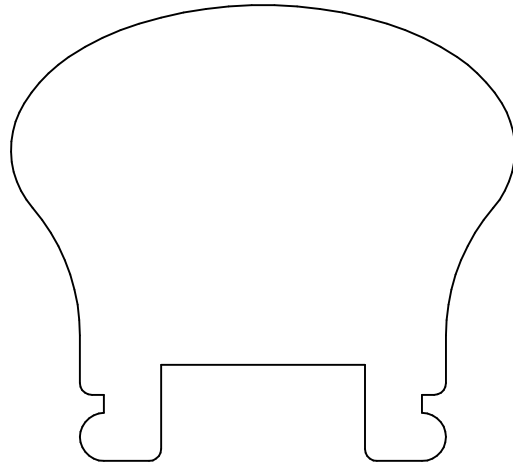

KL 6934P
2.375 x 2.625

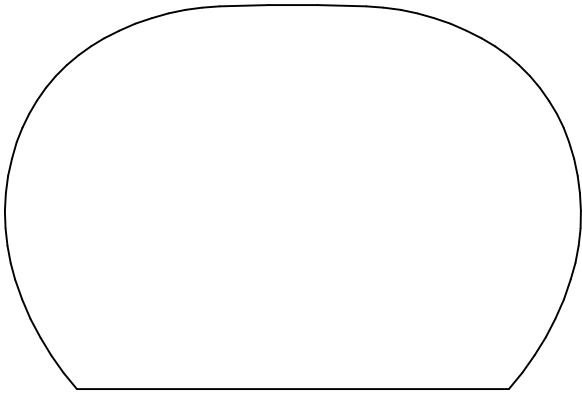

KL 6935
2.000 x 3.000

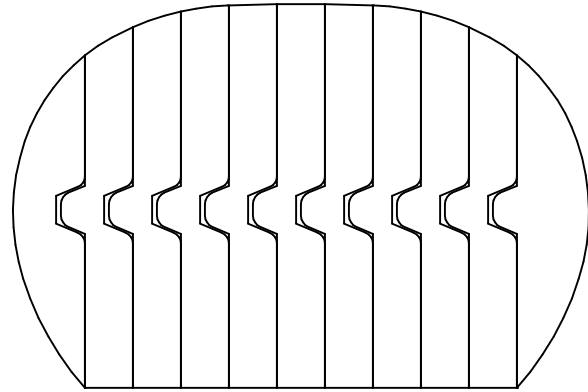

KL 6935B
2.000 x 3.000

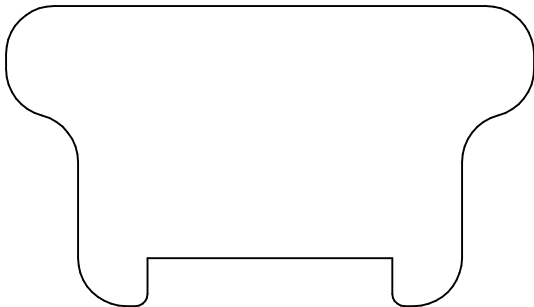

KL 6936P
1.563 x 2.750

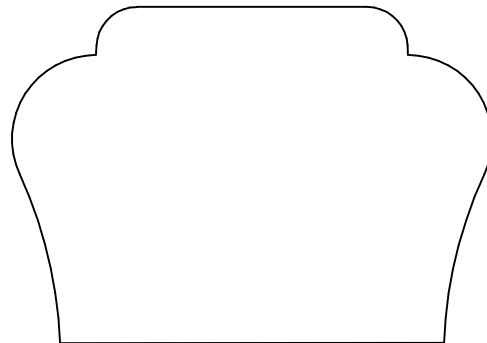

KL 6937
1.750 x 2.500

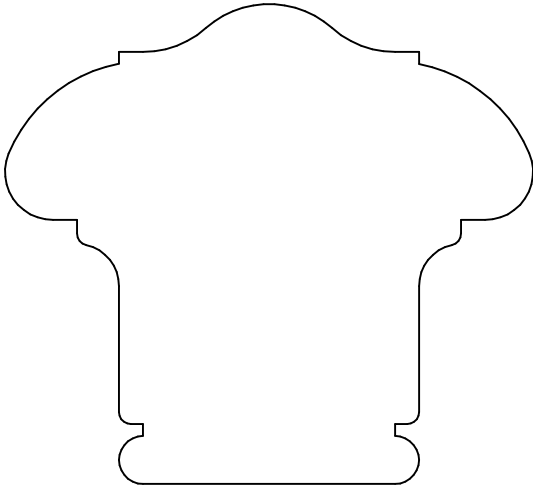

KL 6938
2.500 x 2.750

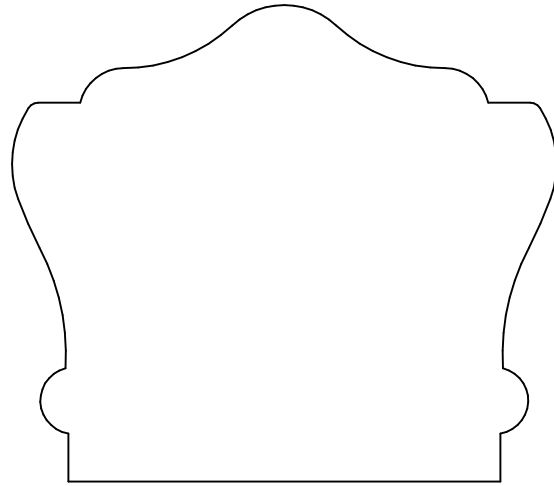

KL 6939
2.482 x 2.836

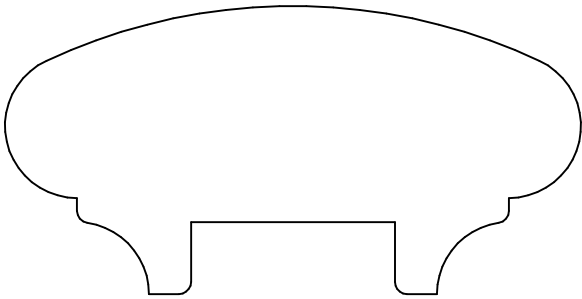

KL 6940P
1.500 x 3.000



KL 6941P
1.125 x 3.000

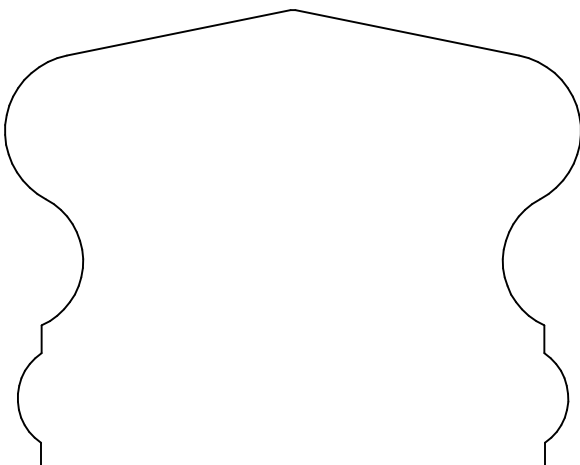

KL 6942
2.375 x 3.000

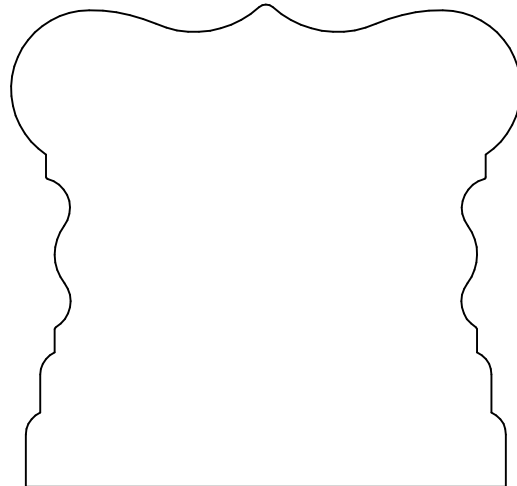

KL 6943
2.512 x 2.656

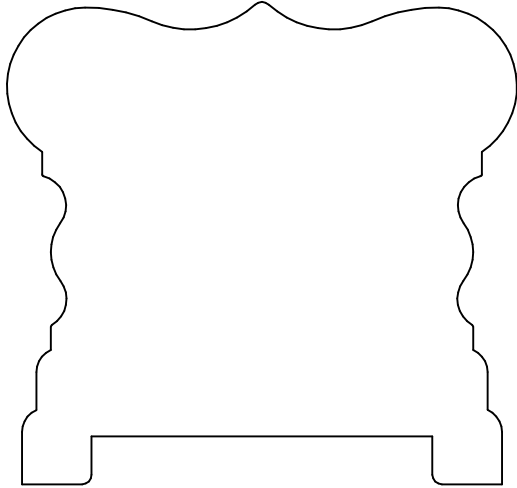

KL 6943P
2.512 x 2.656

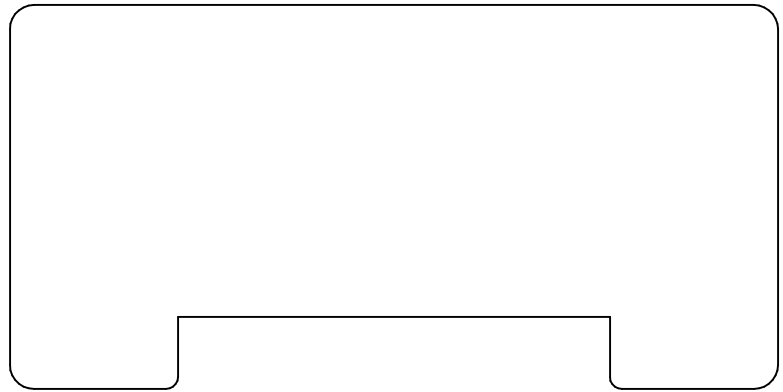

KL 6944P
2.000 x 4.000

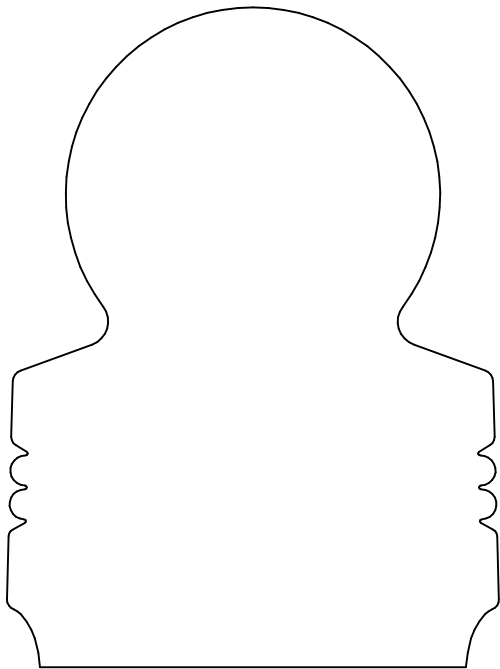

KL 6945
3.438 x 2.562

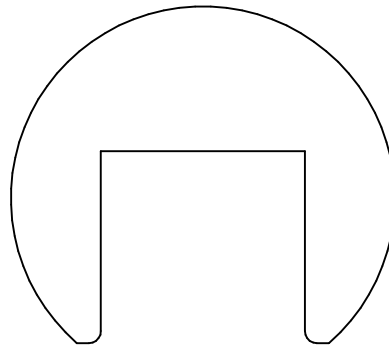

KL 6947P
1.754 x 2.000

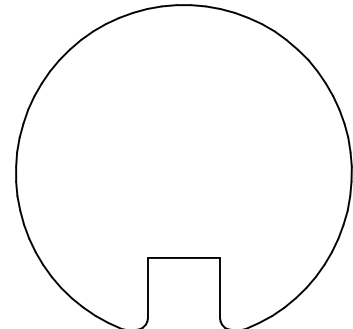

KL 6953P
1.692 x 1.750

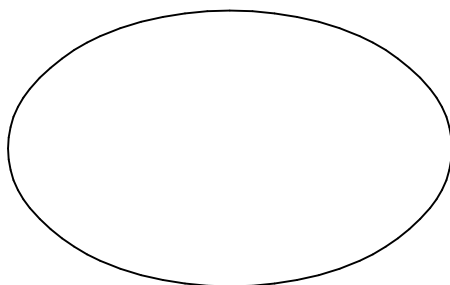

KL 6956
1.438 x 2.312

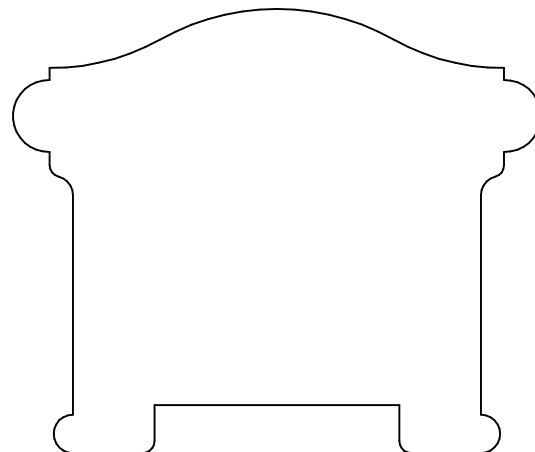

KL 6951P
2.312 x 2.750

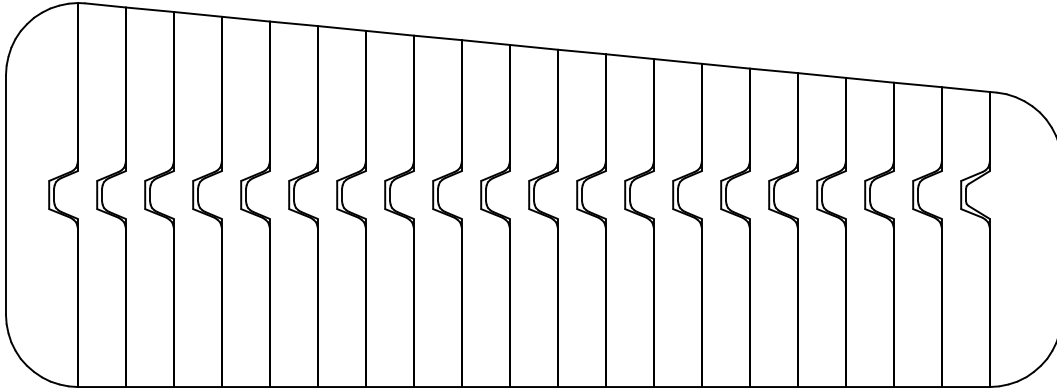

KL 6949B
2.000 x 5.500

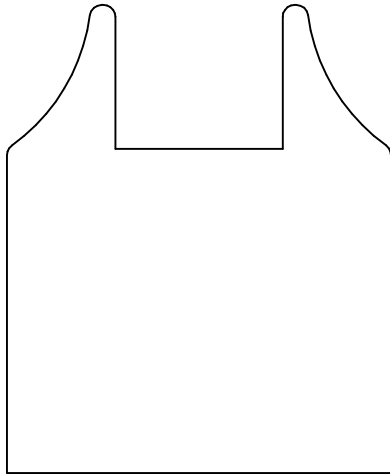

KL 6952-2
2.439 x 2.000

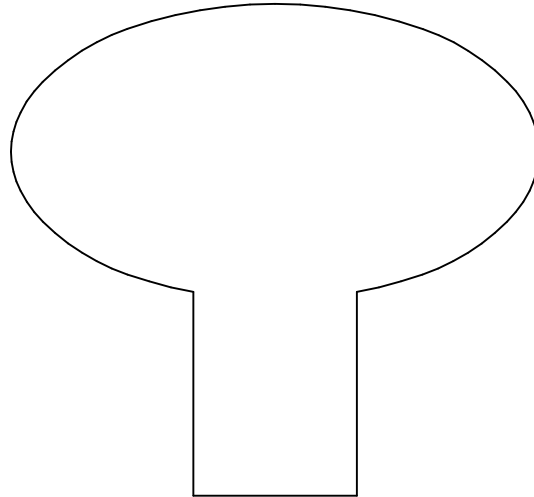

KL 6952-1
2.561 x 2.750

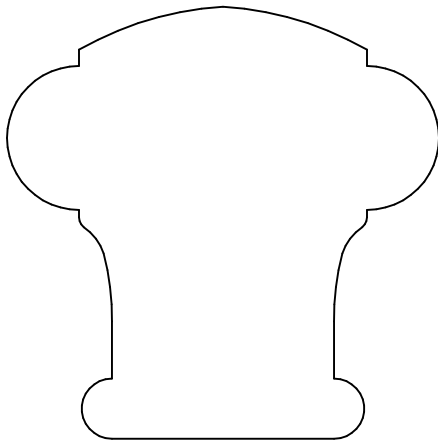

KL 6955
2.250 x 2.250

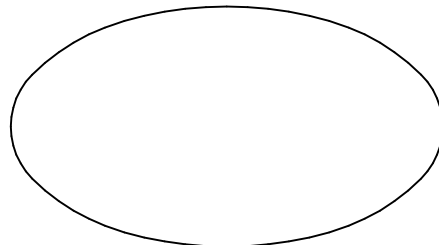

KL 6957
1.250 x 2.250



KL 6961
1.625 x 2.250

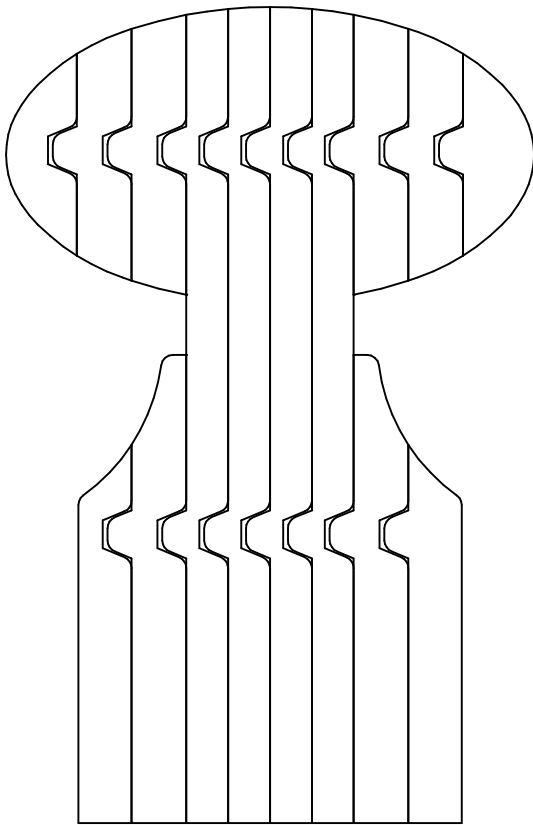

KL 6952B
2.750 x 4.250

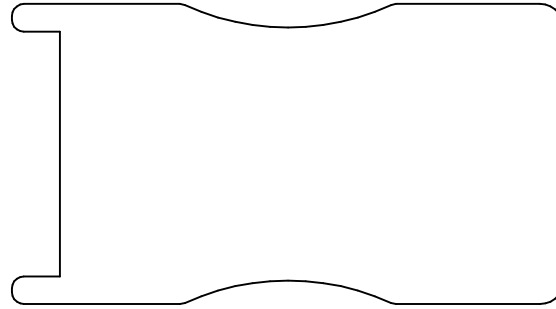

KL 6954P
1.563 x 2.875

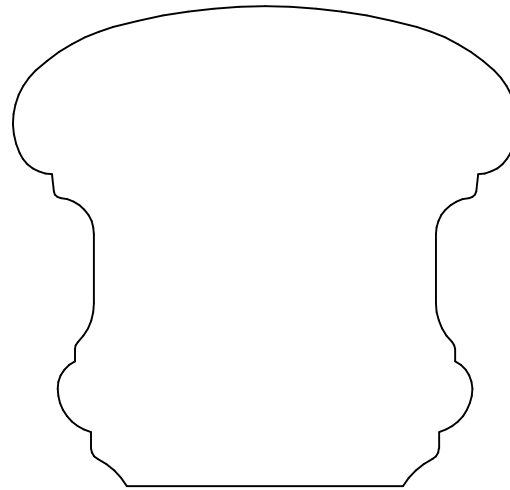

KL 6958
2.500 x 2.625

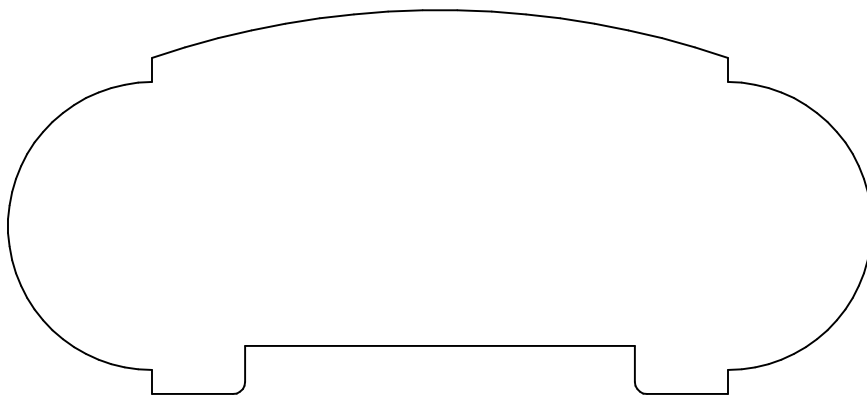

KL 6959P
2.000 x 4.500

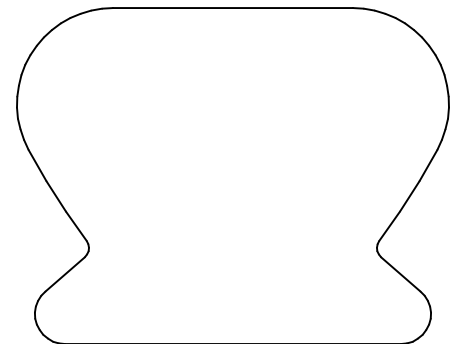

KL 6963
1.750 x 2.250

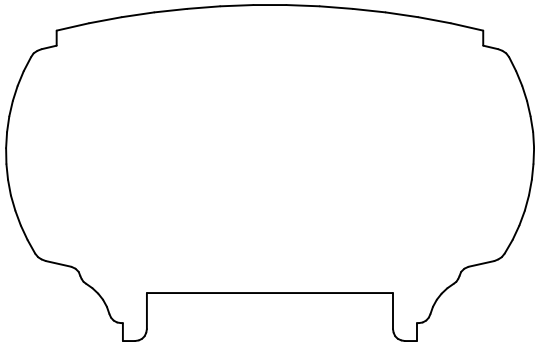

KL 6960P
1.750 x 2.750

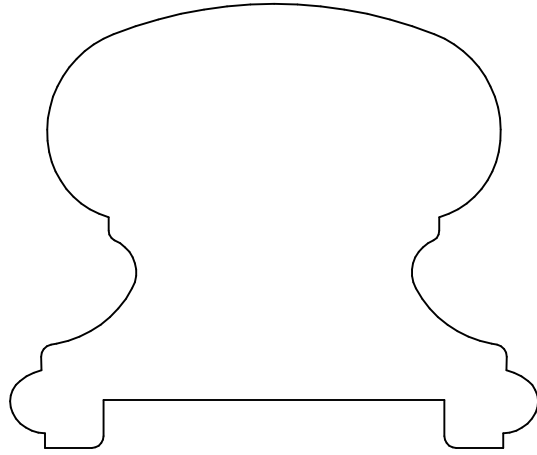

KL 6964P
2.312 x 2.750

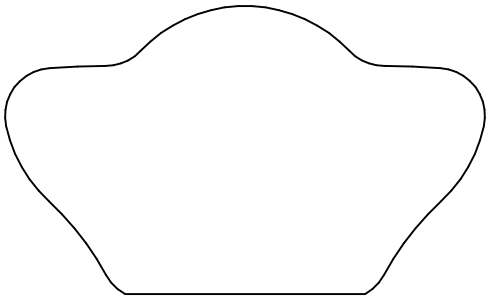

KL 6965
1.500 x 2.500

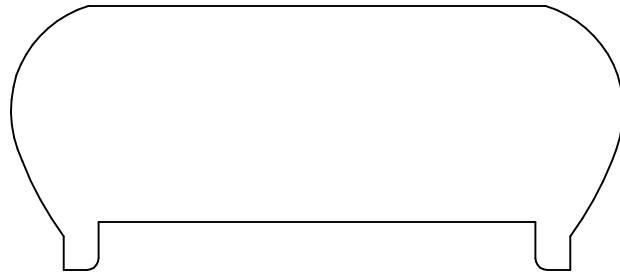

KL 6966P
1.375 x 3.188

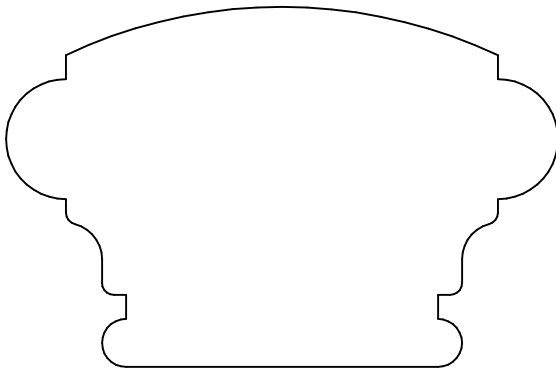

KL 6967
1.875 x 2.875

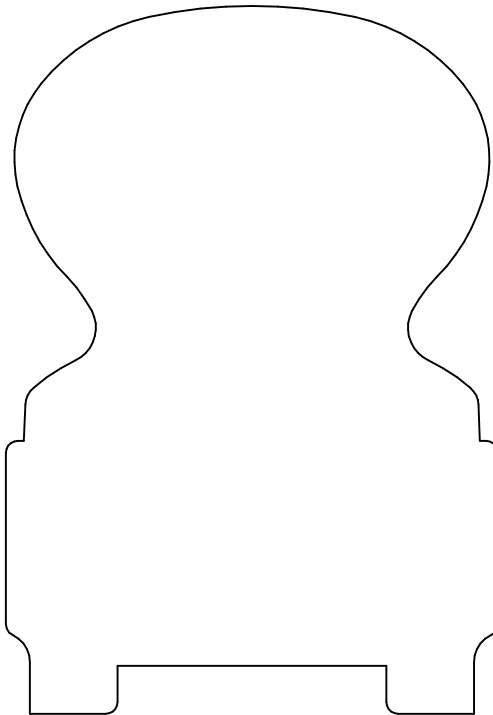

KL 6968P
3.687 x 2.562

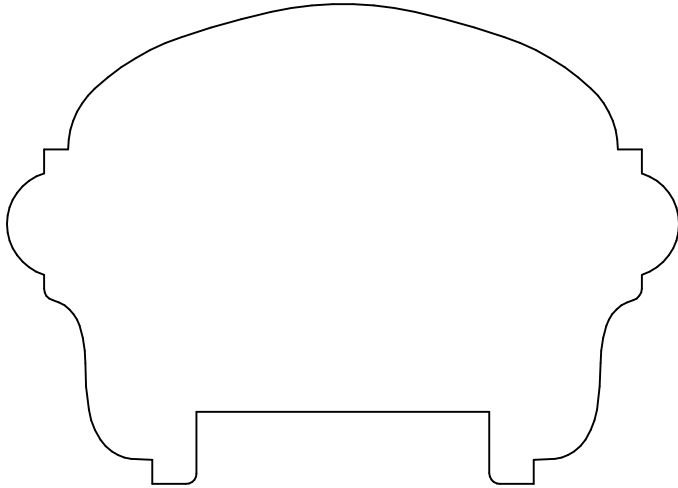

KL 6969P
2.500 x 3.500

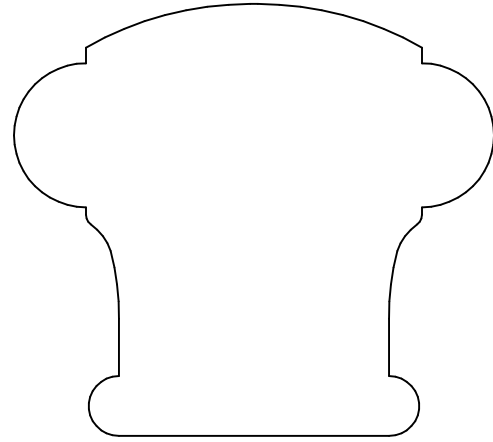

KL 6970
2.250 x 2.500

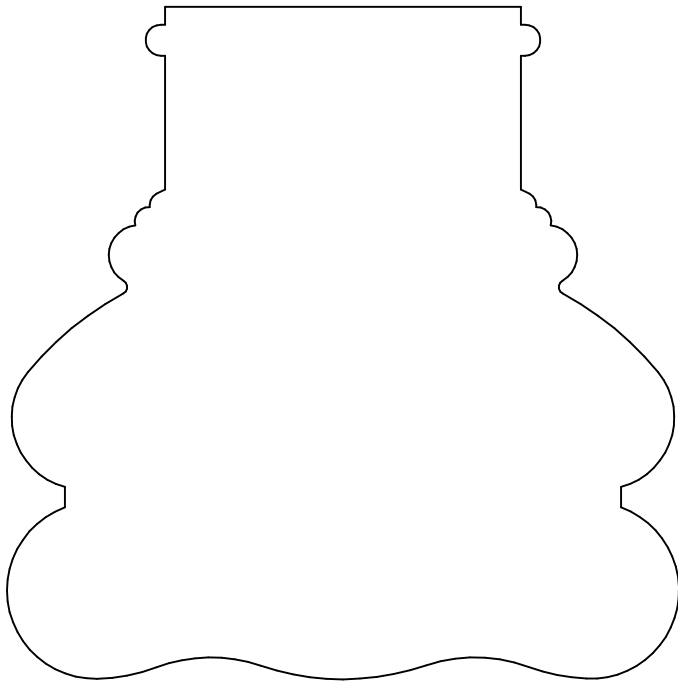

KL 6971
3.500 x 3.500

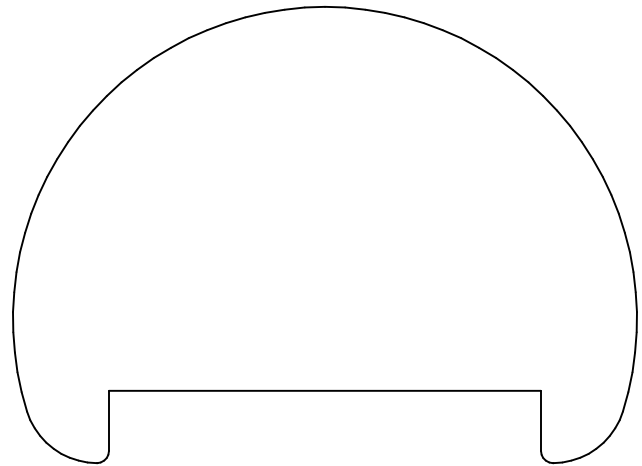

KL 6973P
2.375 x 3.250

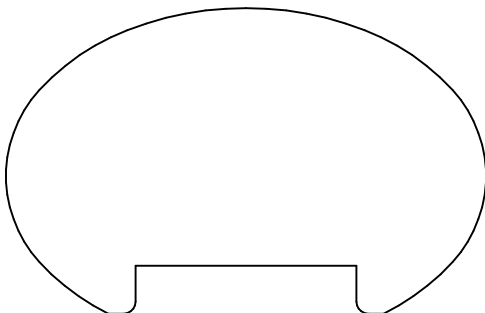

KL 6979P
1.592 x 2.500

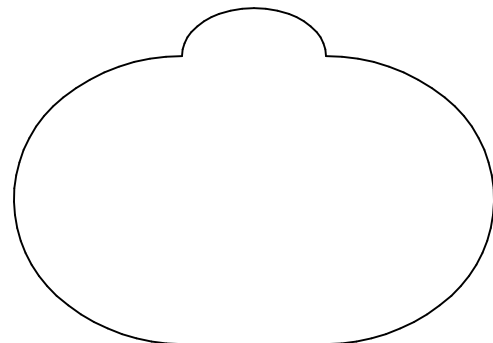

KL 6974
1.750 x 2.500

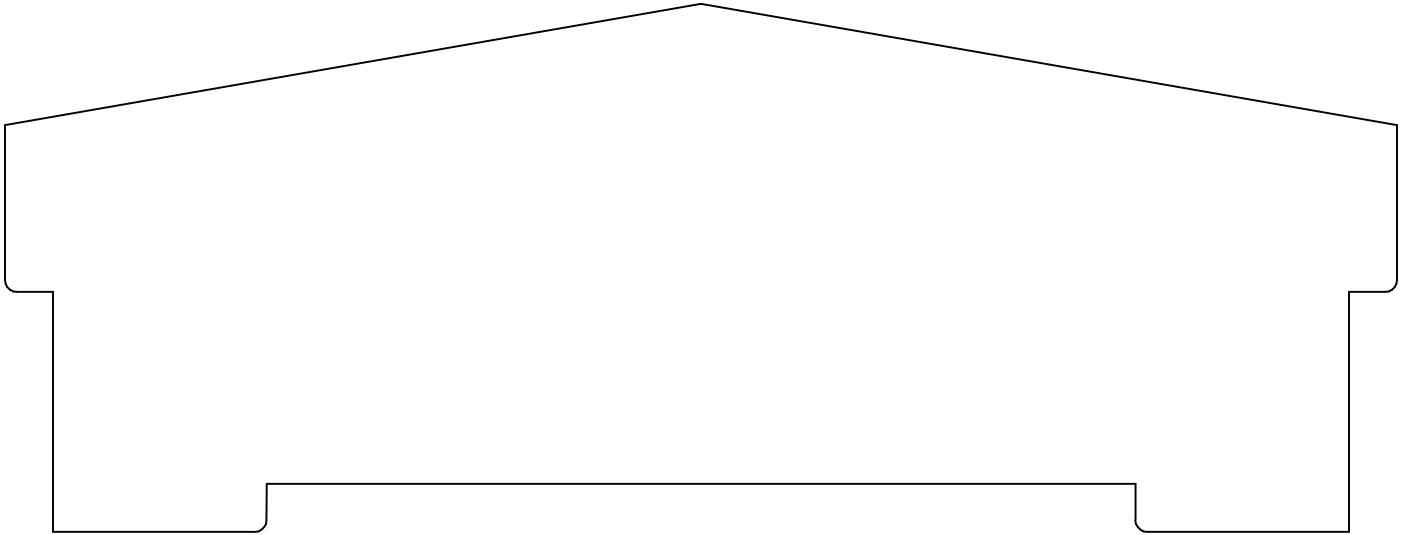

KL 6972P
2.750 x 7.250

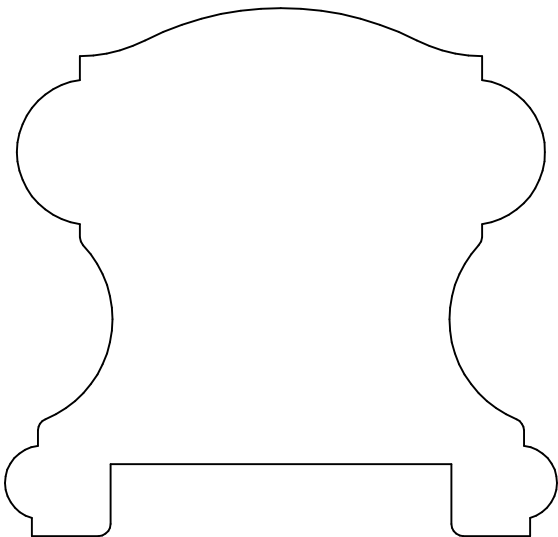

KL 6975P
2.750 x 2.875

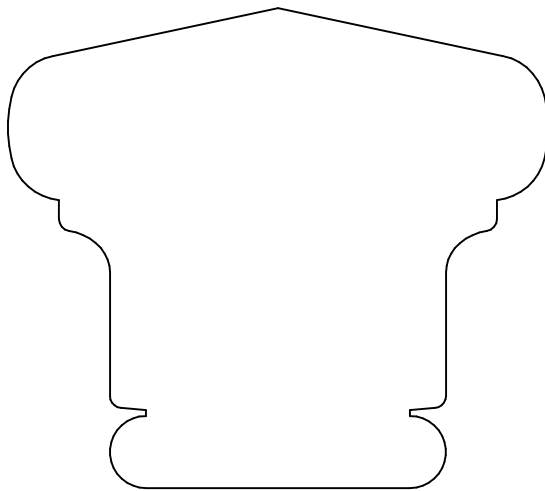

KL 6976
2.500 x 2.813



KL 6994
.313 x .937

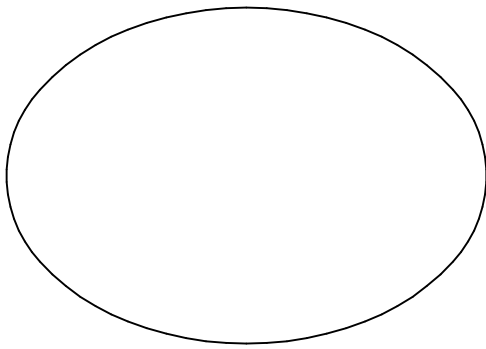

KL 6979
1.750 x 2.500

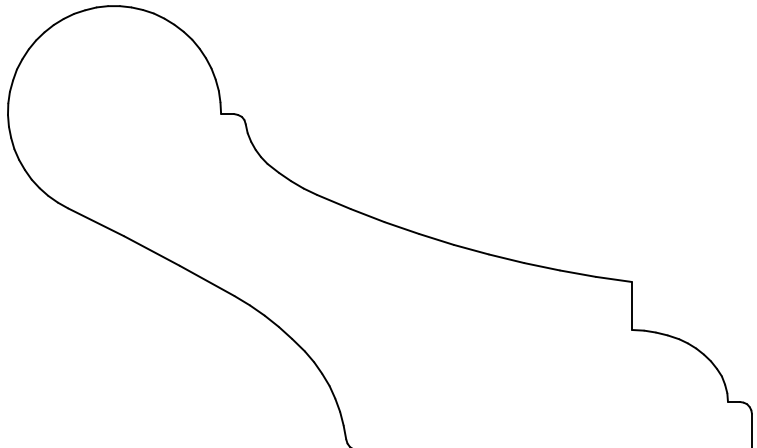

KL 6977
2.312 x 3.875

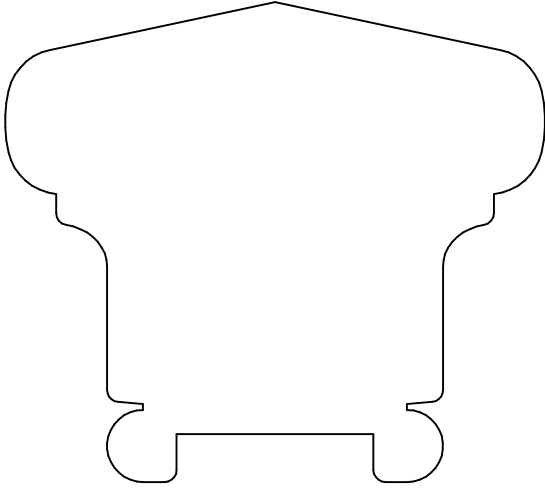

KL 6976P
2.500 x 2.813

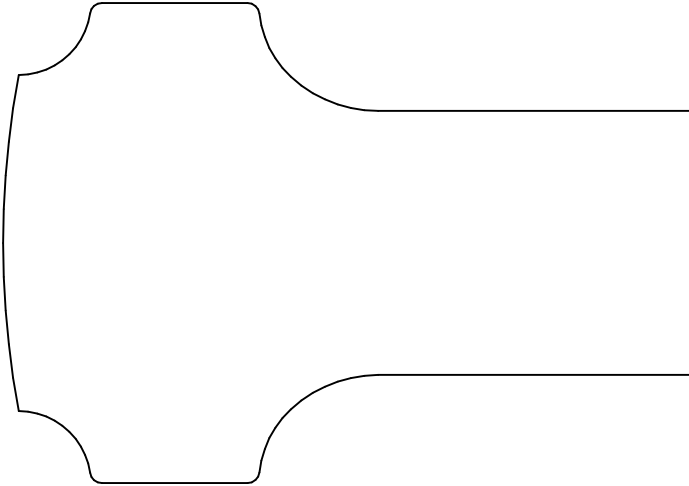

KL 6978
3.594 x 2.500

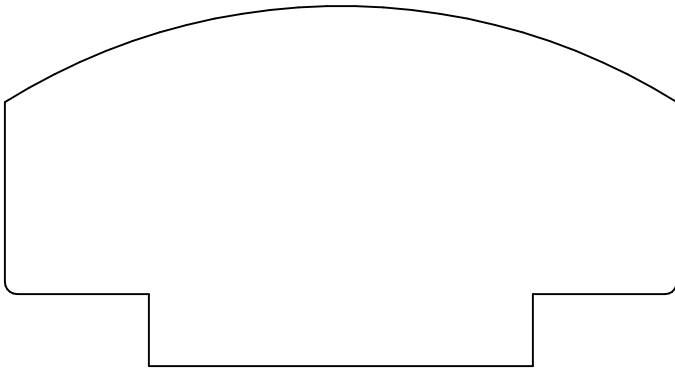

KL 6980
1.875 x 3.500

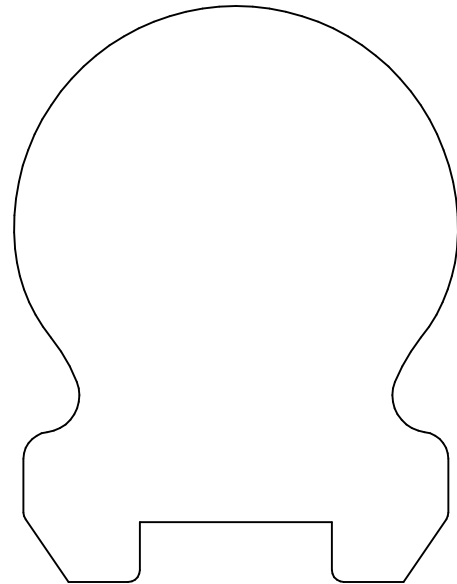

KL 6981P
3.000 x 2.312

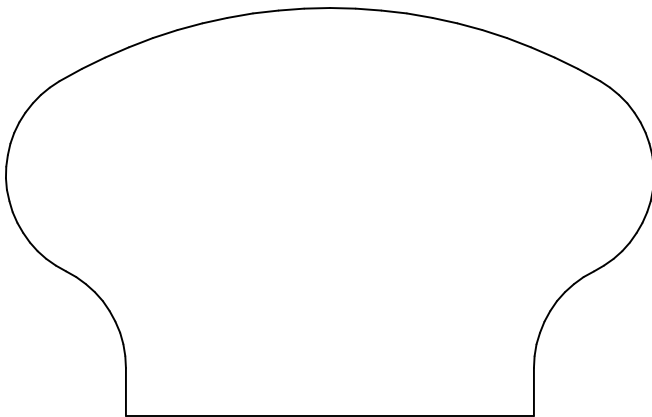

KL 6983
2.125 x 3.375

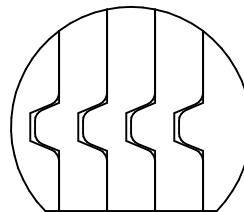

KL 6986B
1.062 x 1.250

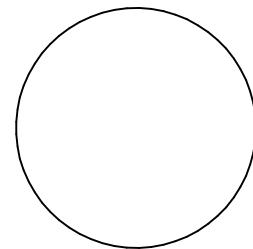

KL 6987
1.250 x 1.250

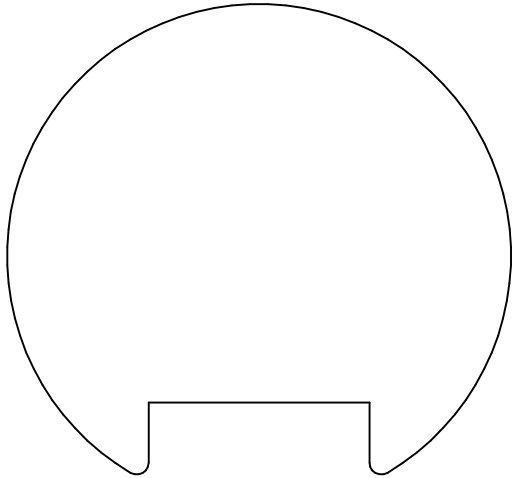

KL 6982P
2.451 x 2.625

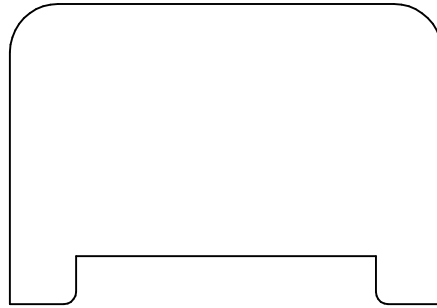

KL 6984P
1.563 x 2.250

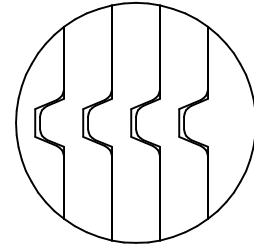

KL 6987B
1.250 x 1.250

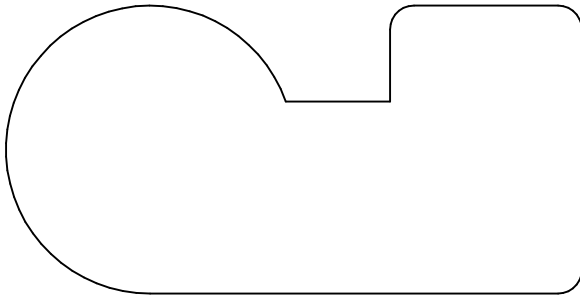

KL 6985
1.500 x 3.000

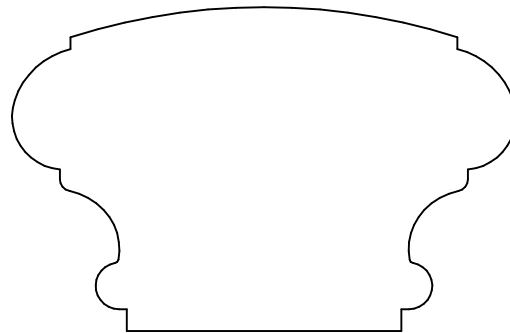

KL 6988
1.687 x 2.625

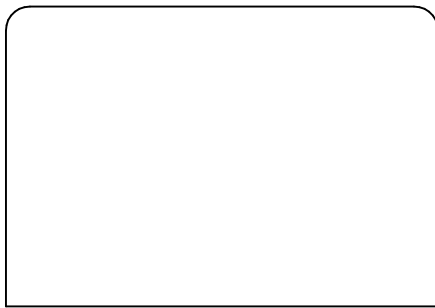

KL 6989
1.562 x 2.250

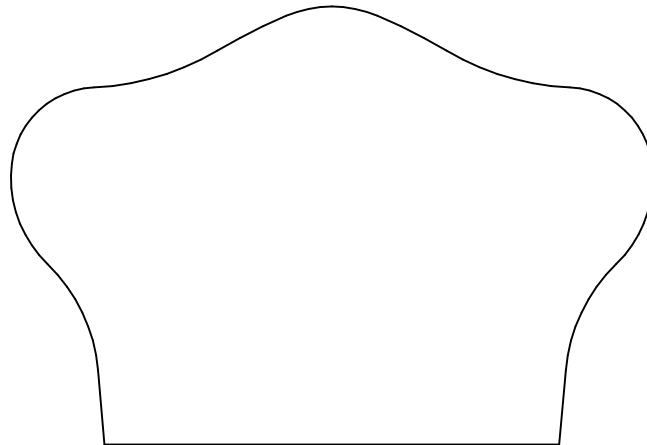

KL 6990
2.281 x 3.343

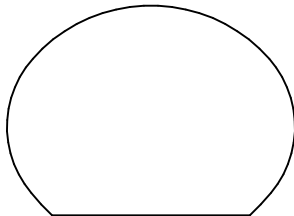

KL 6996
1.093 x 1.500

CUSTOM PROFILES

Handrail

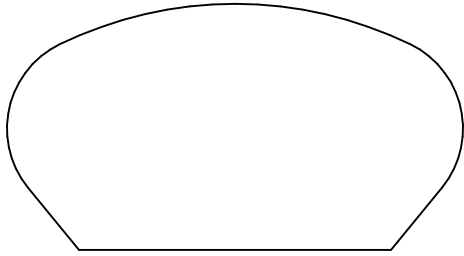

KL 6991
1.281 x 2.375

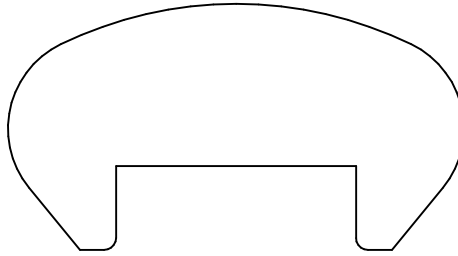

KL 6991P
1.281 x 2.375



KL 6998P
1.000 x 2.000

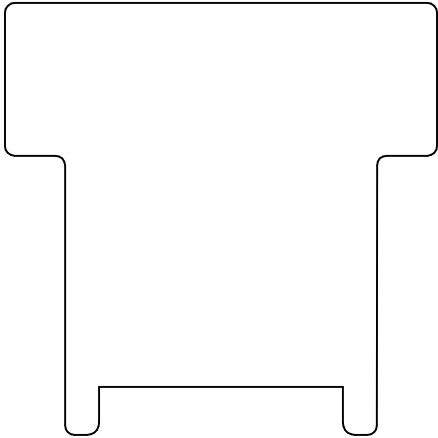

KL 6992P
2.250 x 2.250

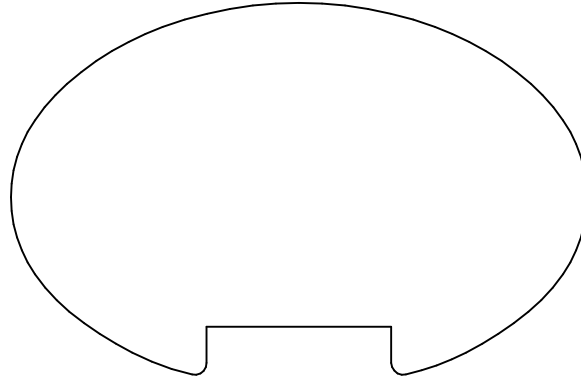

KL 6993P
1.937 x 3.000

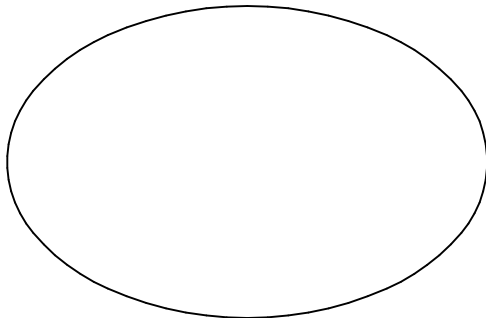

KL 6995
1.625 x 2.500

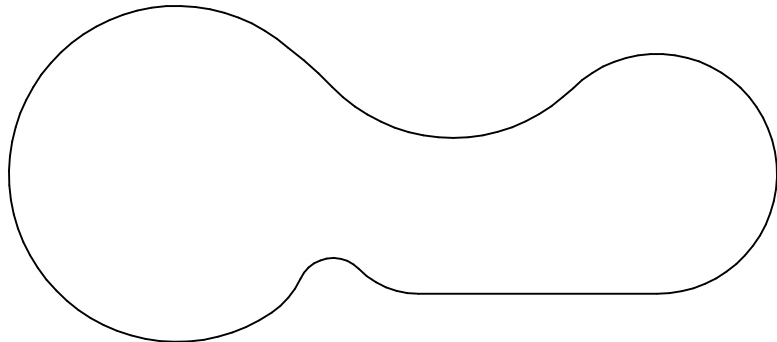

KL 6997
1.750 x 4.000



KL 6999P
1.500 x 4.000

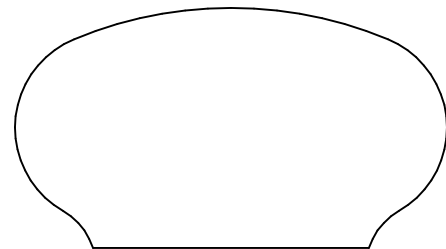

KL 7900
1.250 x 2.250

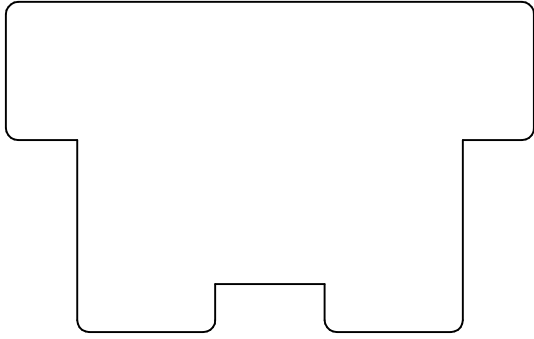

KL 7901P
1.719 x 2.750

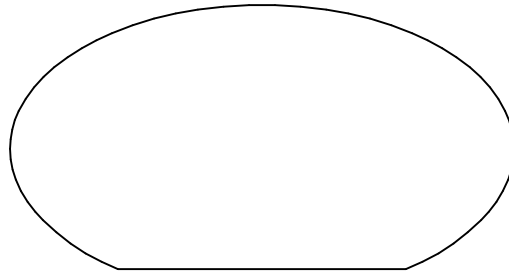

KL 7902
1.375 x 2.625

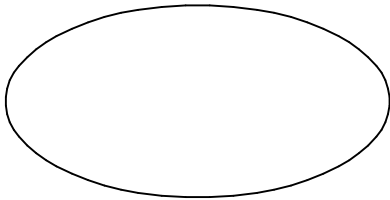

KL 7903
1.000 x 2.000

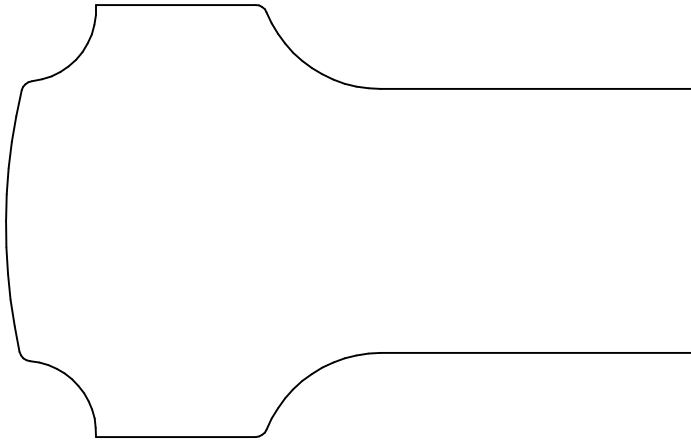

KL 7904
2.250 x 3.593

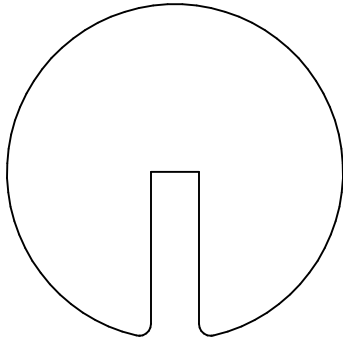

KL 7905P
1.728 x 1.750

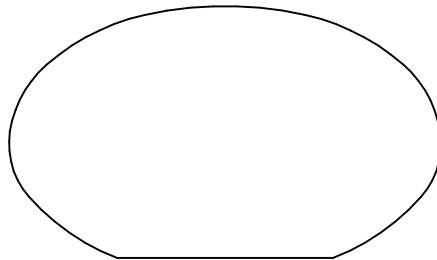

KL 7906
1.312 x 2.250

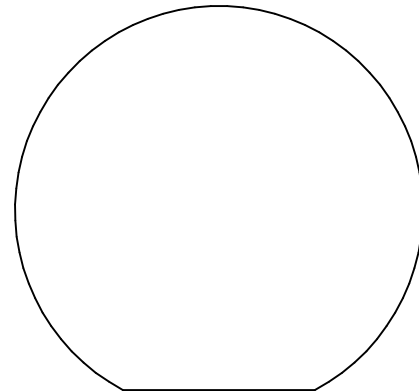

KL 7908
2.000 x 2.125

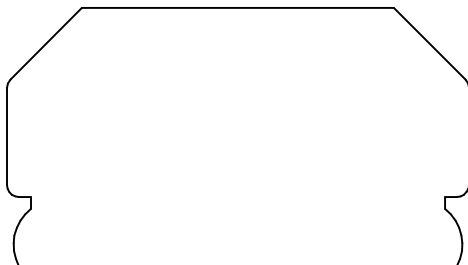

KL 7910
1.344 x 2.406



KL 7911
.781 x 2.438



KL 7926
.625 x 1.500

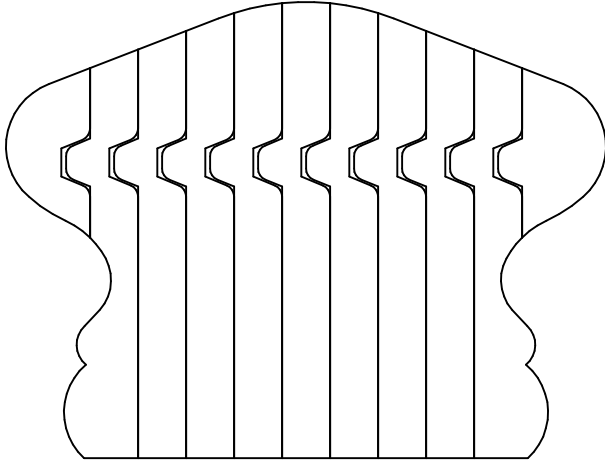

KL 7907B
2.375 x 3.125

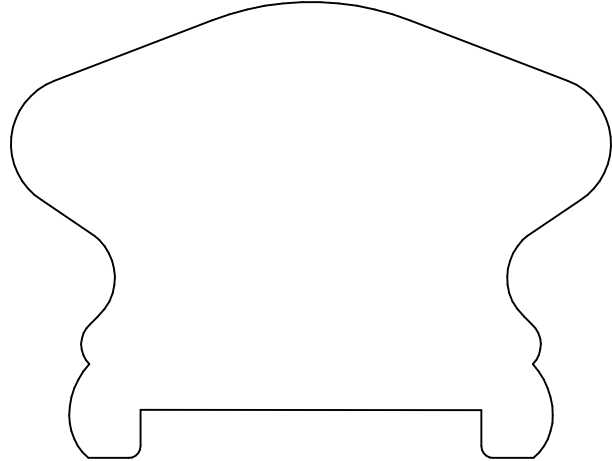

KL 7907P
2.375 x 3.125

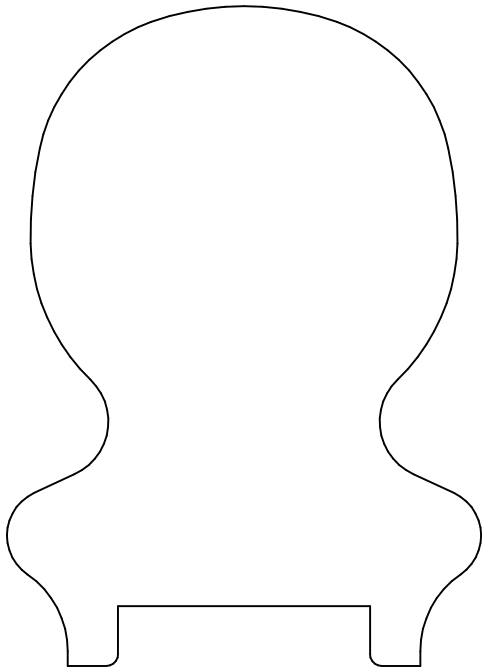

KL 7909P
3.438 x 2.469

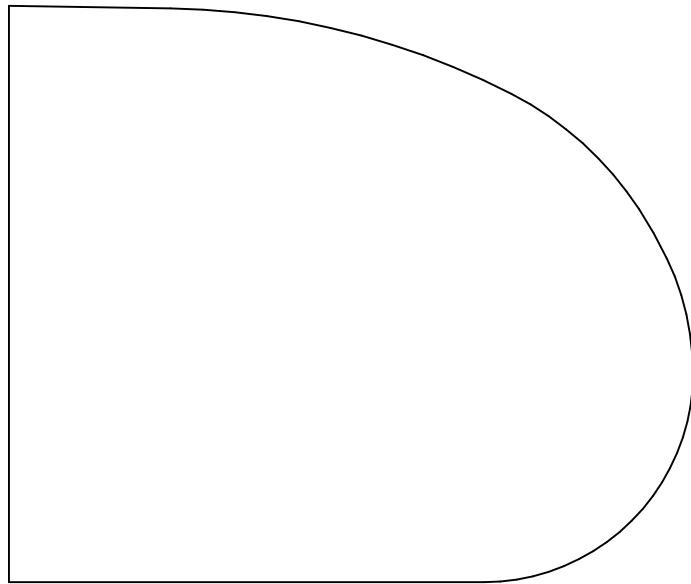

KL 7912
3.000 x 3.562

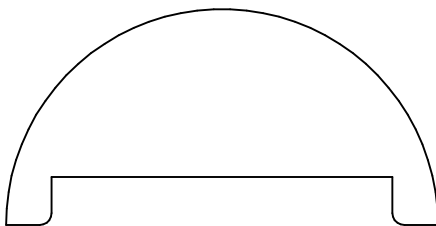

KL 7914P
1.125 x 2.250

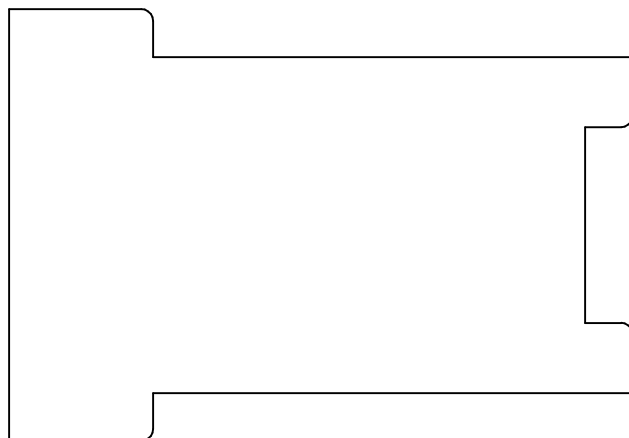

KL 7913P
2.250 x 3.250

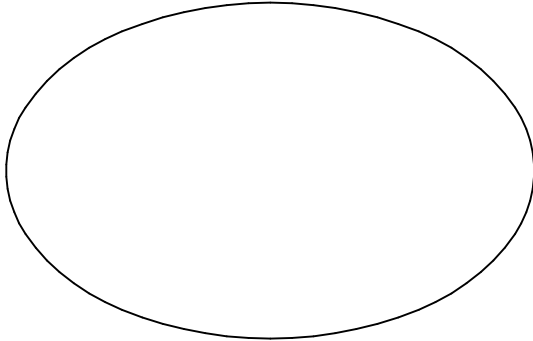

KL7915
1.750 x 2.750

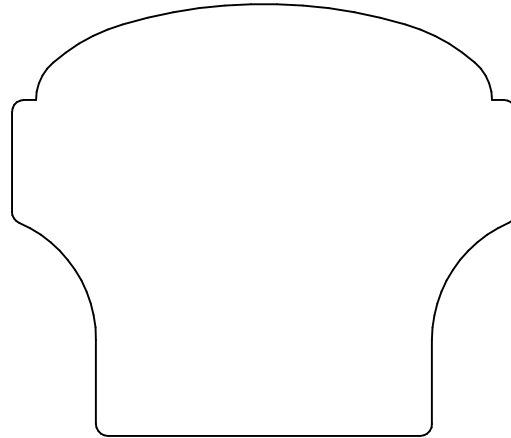

KL 7916
2.250 x 2.625

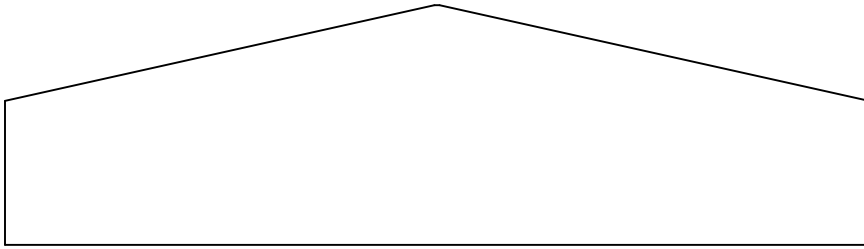

KL 7917
1.250 x 4.500

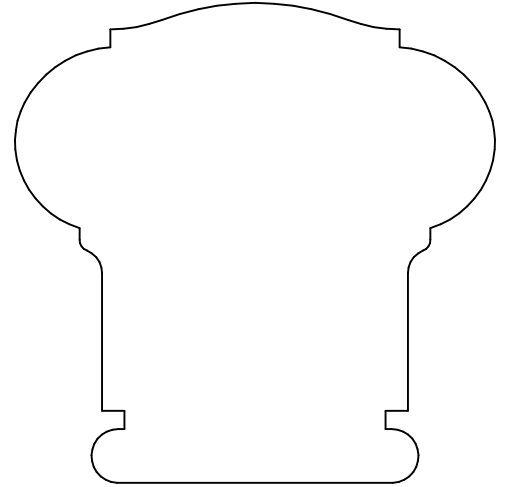

KL 7920
2.500 x 2.500

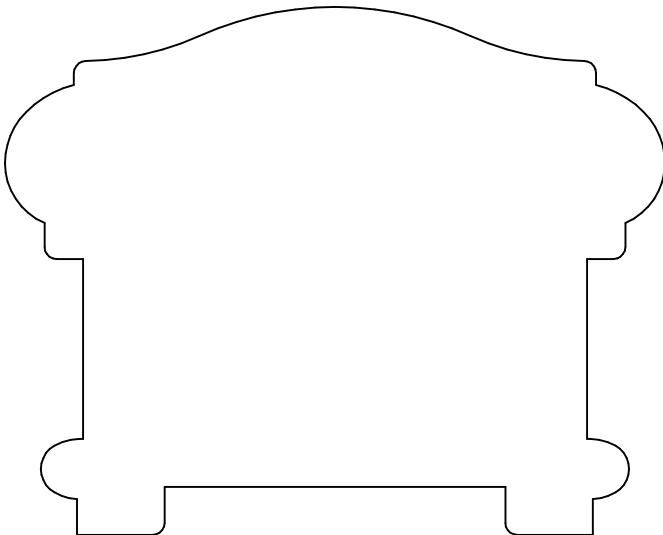

KL 7918P
2.750 x 3.437

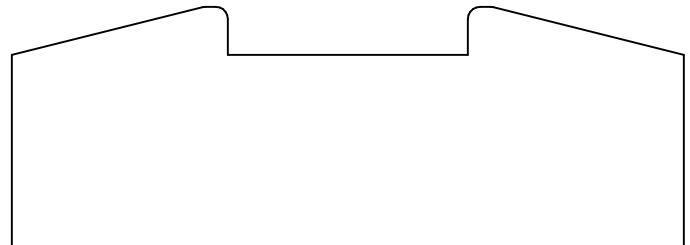

KL 7921P
1.250 x 3.500

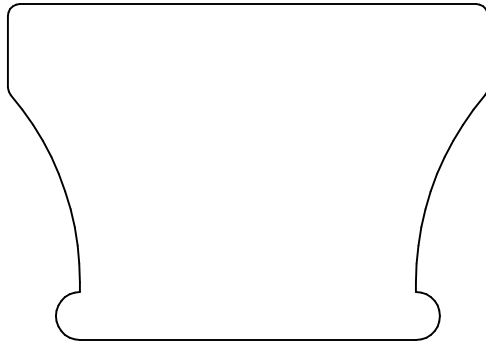

KL 7922
1.750 x 2.500

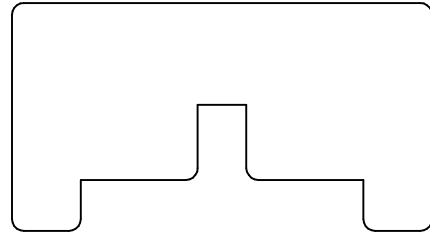

KL 7923P
1.187 x 2.188

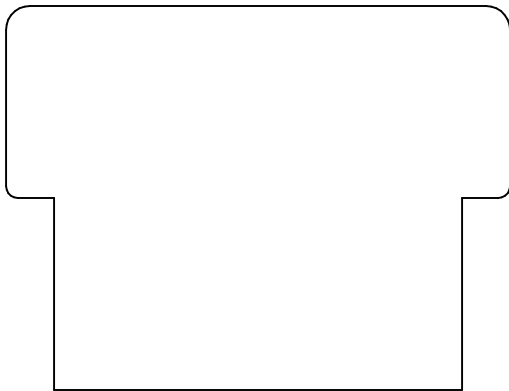

KL 7924
2.000 x 2.625

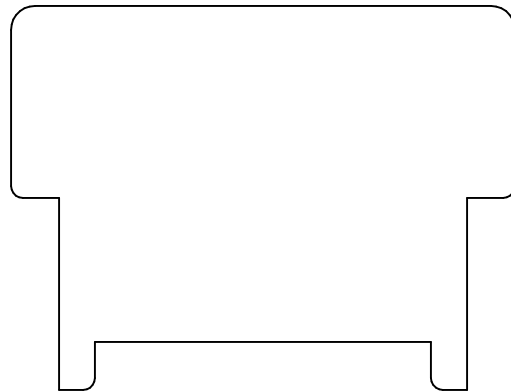

KL 7924P
2.000 x 2.625

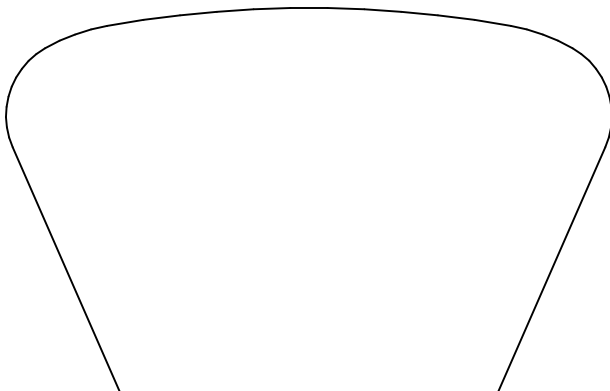

KL 7927
2.000 x 3.156

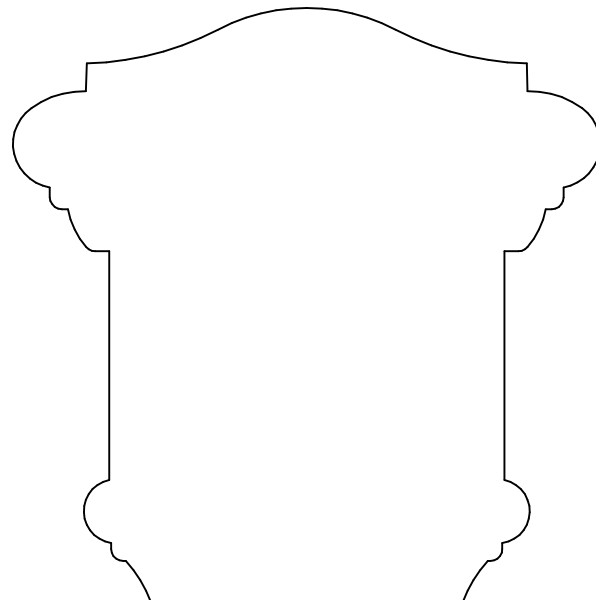

KL 7928
3.094 x 3.059

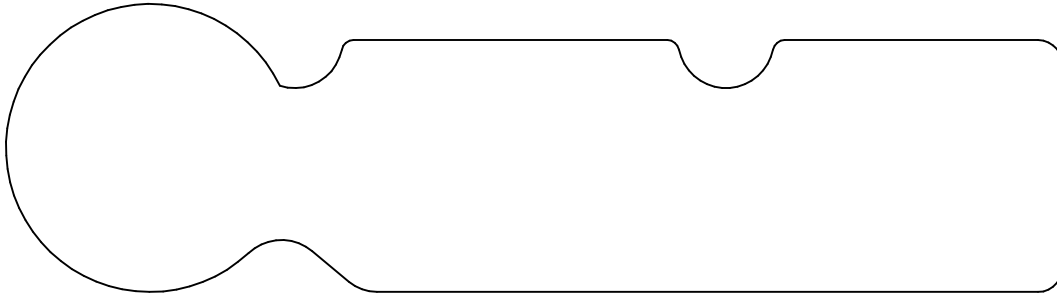

KL 7929
1.500 x 5.500

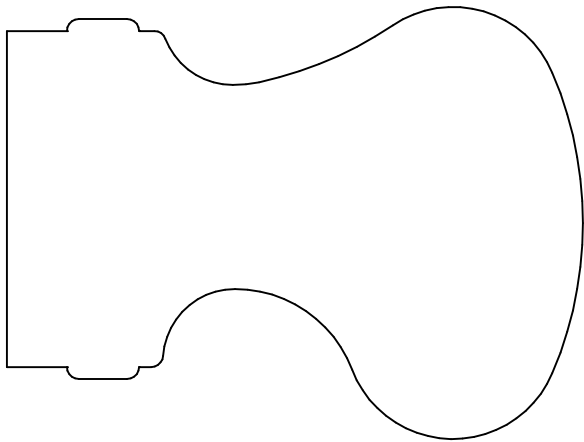

KL 7930
3.000 x 2.250

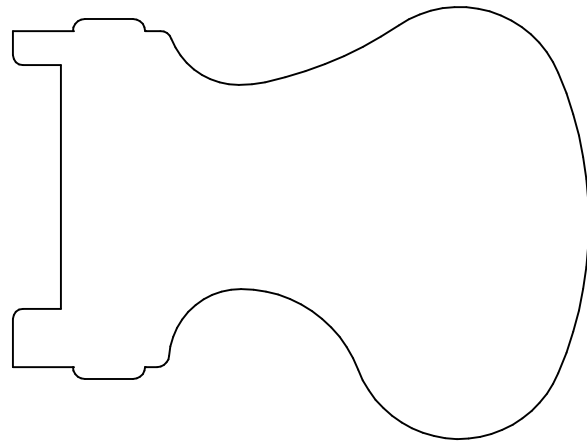

KL 7930P
3.000 x 2.250

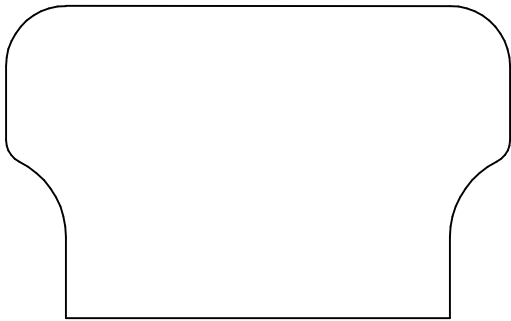

KL 7931
1.625 x 2.625

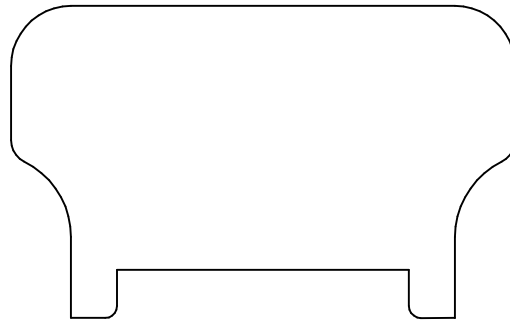

KL 7931P
1.625 x 2.625

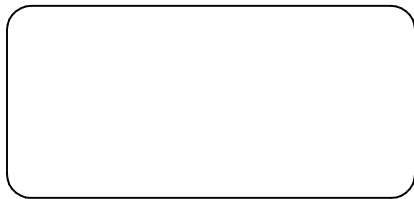

KL 7942
1.000 x 2.125



KL 7942P
1.000 x 2.125

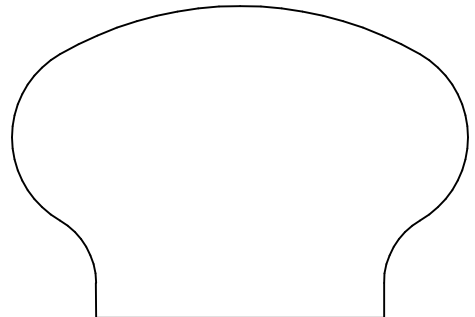

KL 7944
1.625 x 2.375

CUSTOM PROFILES

Handrail

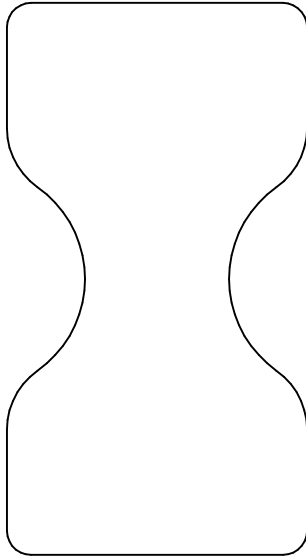

KL 7932
1.562 x 2.875

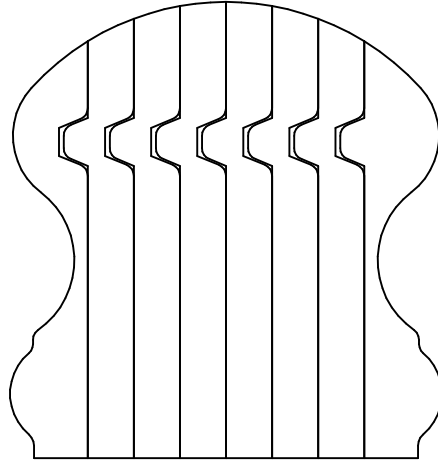

KL 7933BR
2.375 x 2.250

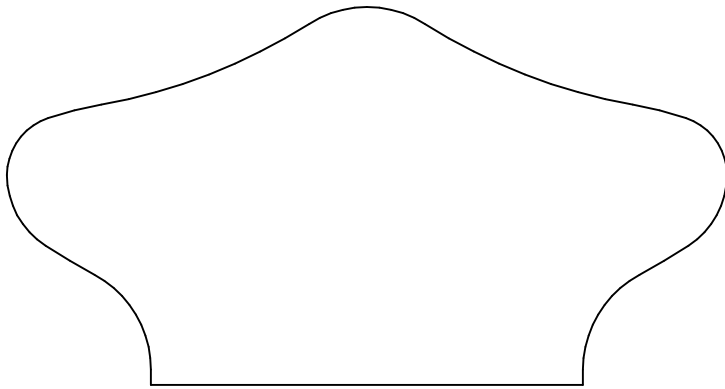

KL 7933
1.969 x 3.750

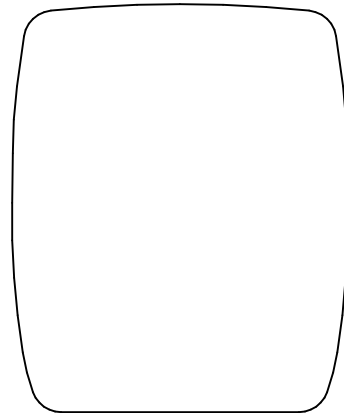

KL 7934
2.125 x 1.750

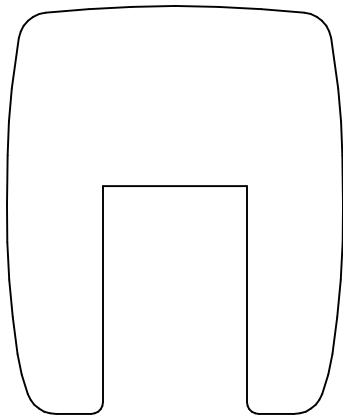

KL 7934P
2.125 x 1.750

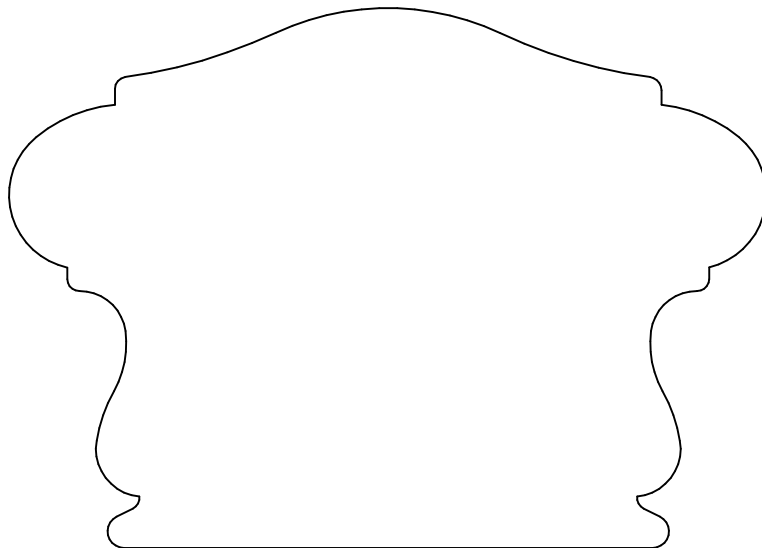

KL 7935
2.812 x 3.944

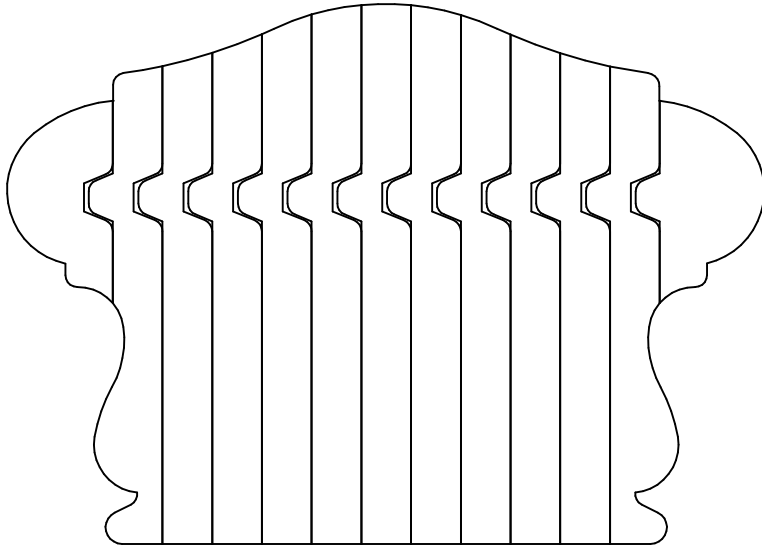

KL 7935BR
2.812 x 3.944

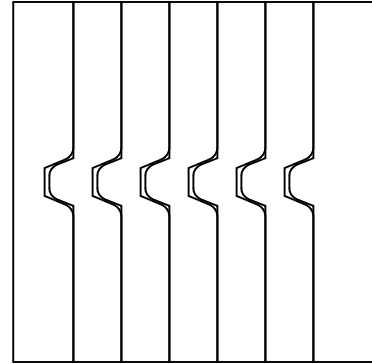

KL 7936BR
1.875 x 1.875

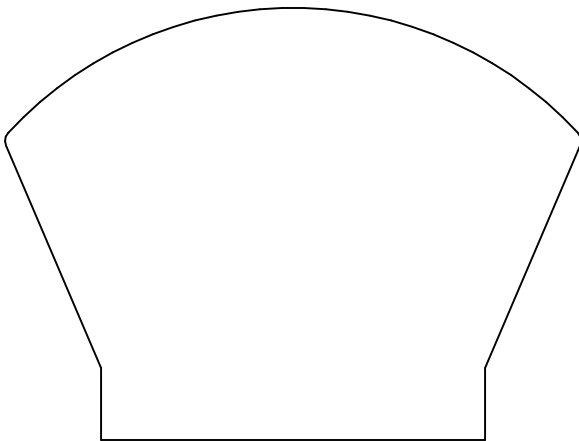

KL 7937
2.250 x 3.000

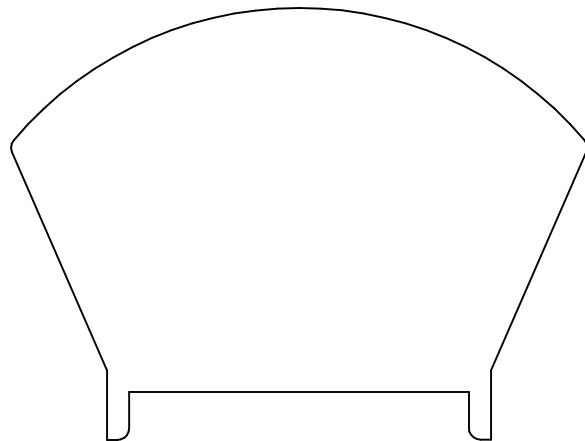

KL 7937P
2.250 x 3.000

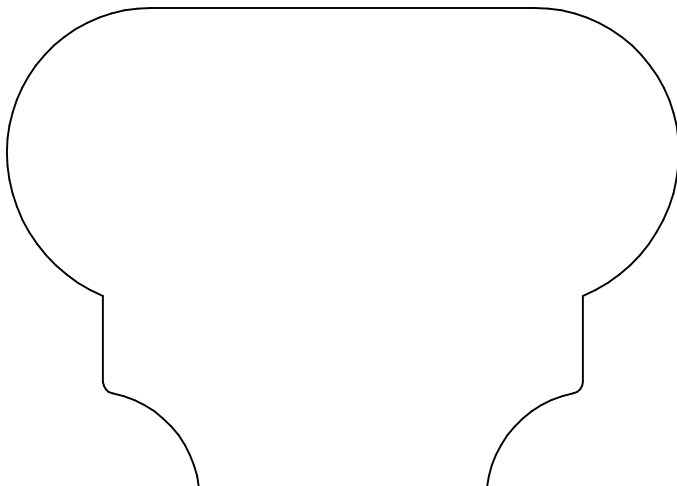

KL 7938
2.500 x 3.500

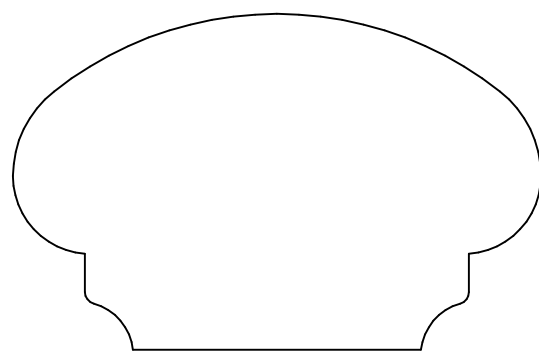

KL 7939
1.750 x 2.750

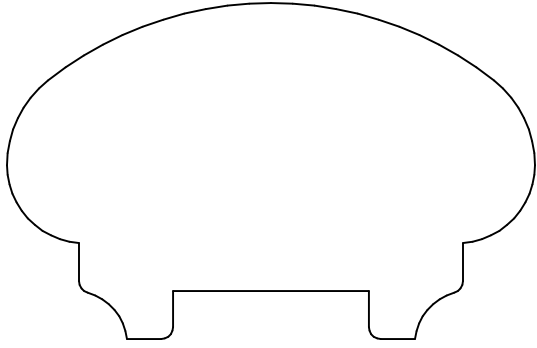

KL 7939P
1.750 x 2.750

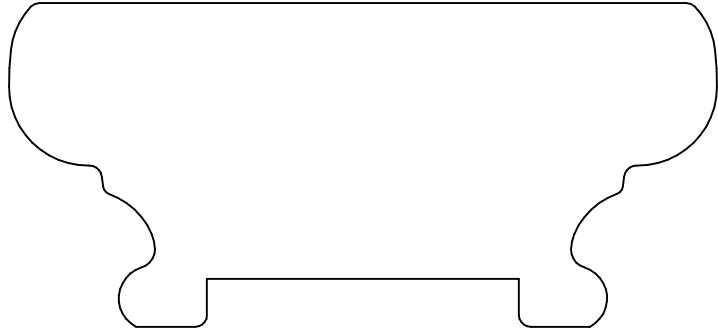

KL 7940P
1.687 x 3.688

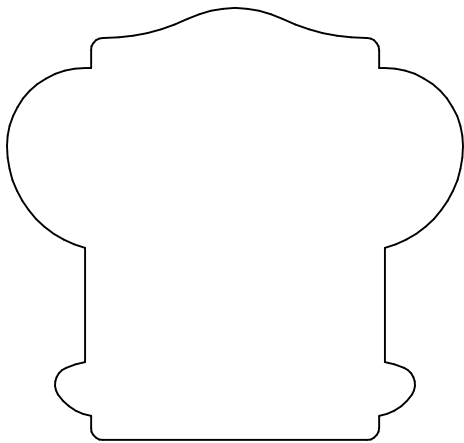

KL 7941
2.250 x 2.375

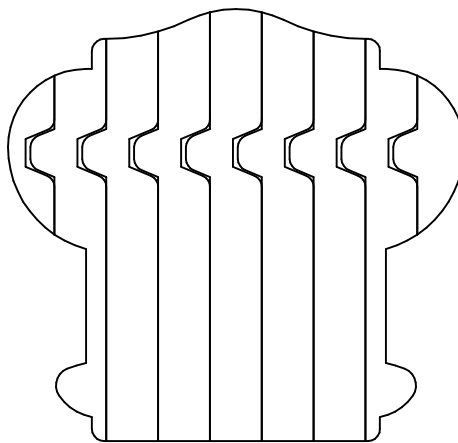

KL 7941BR
2.250 x 2.375

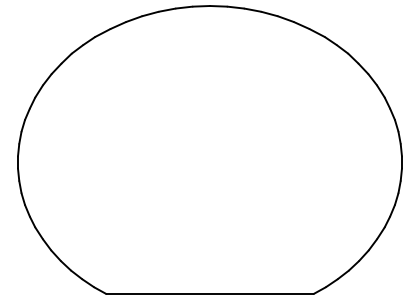

KL 7946
1.500 x 2.000

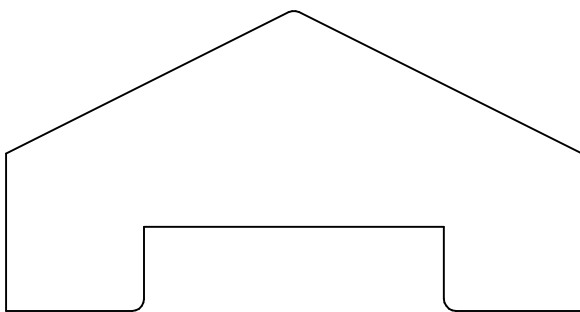

KL 7943P
1.562 x 3.000

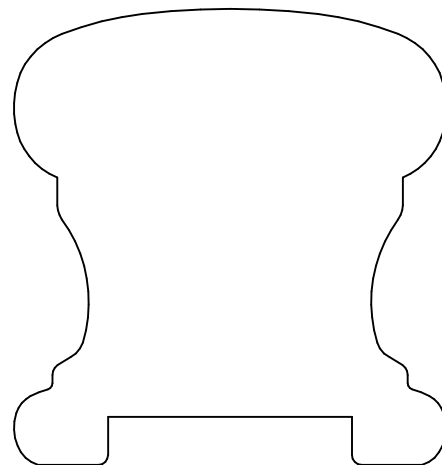

KL 7945P
2.375 x 2.250

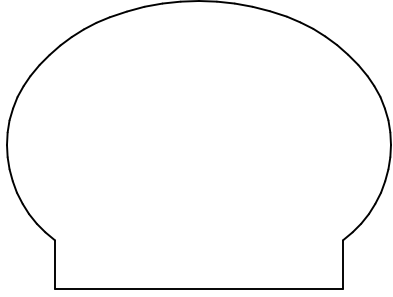

KL 7947
1.500 x 2.000

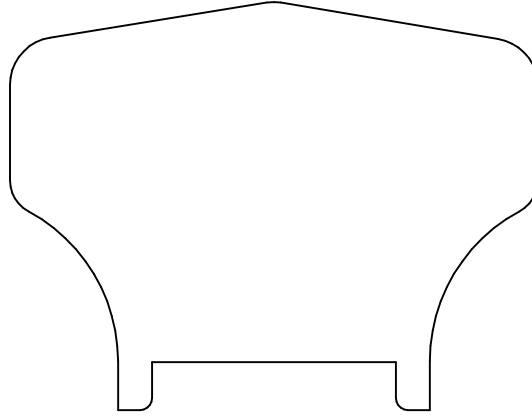

KL 7948P
2.125 x 2.750

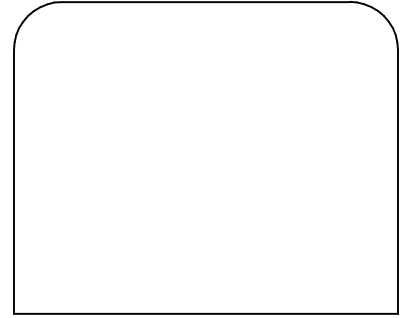

KL 7949
1.625 x 2.000

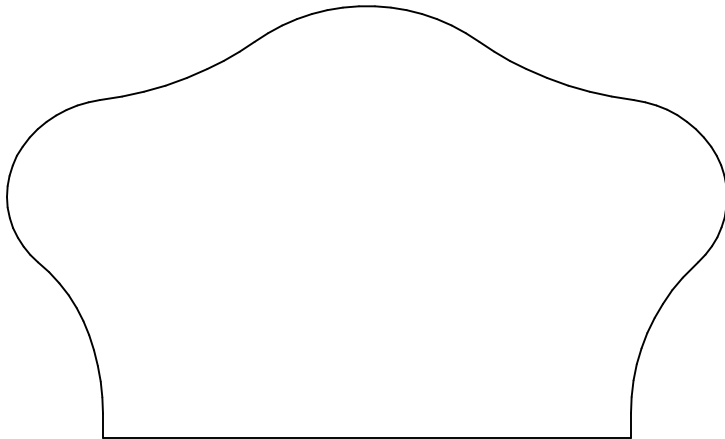

KL 7950
2.250 x 3.750

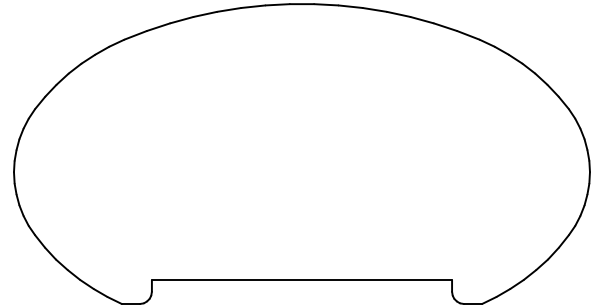

KL 7953P
1.562 x 3.000

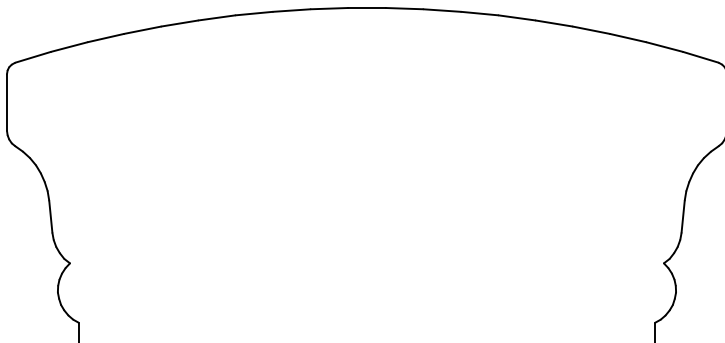

KL 7951
1.750 x 3.750

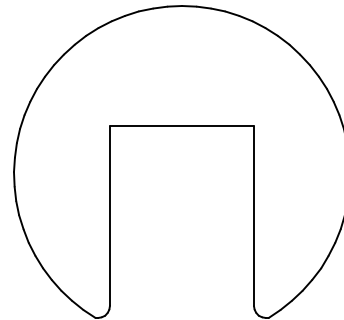

KL 7954P
1.625 x 1.750

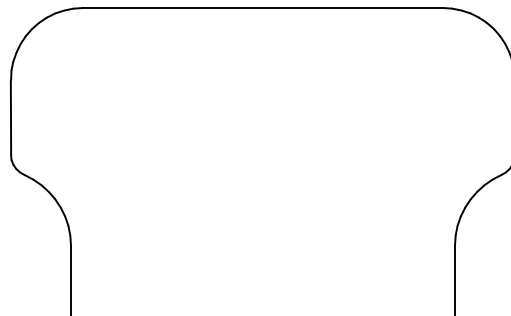

KL 7958
1.625 x 2.625

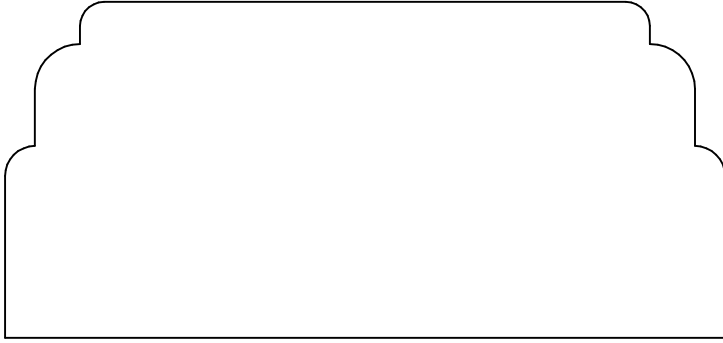

KL 7952
1.750 x 3.750

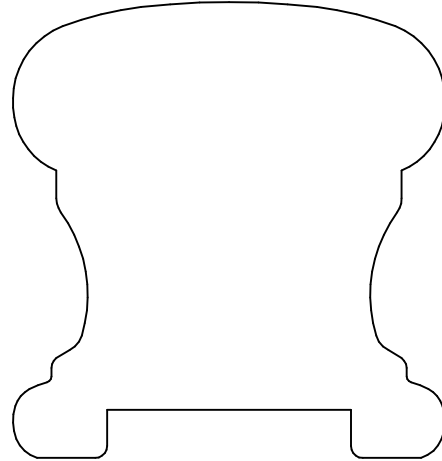

KL 7956P
2.375 x 2.250

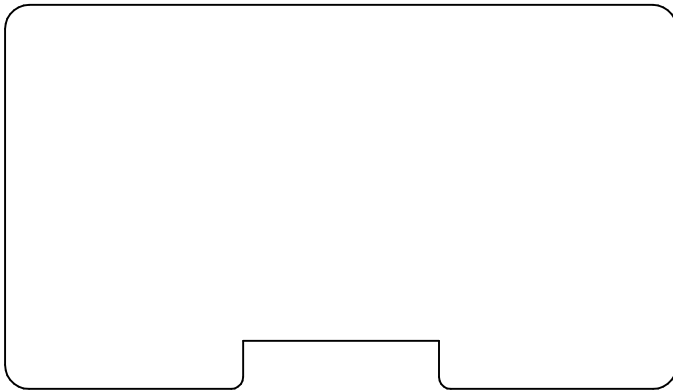

KL 7955P
2.000 x 3.500

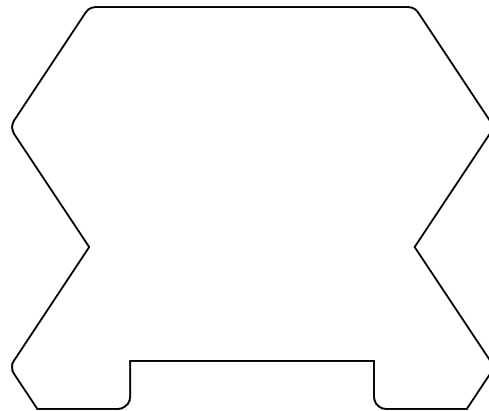

KL 7957P
2.093 x 2.500

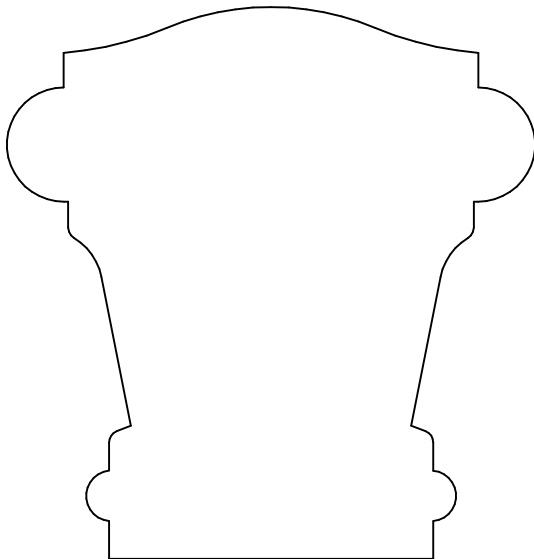

KL 7959
2.875 x 2.750

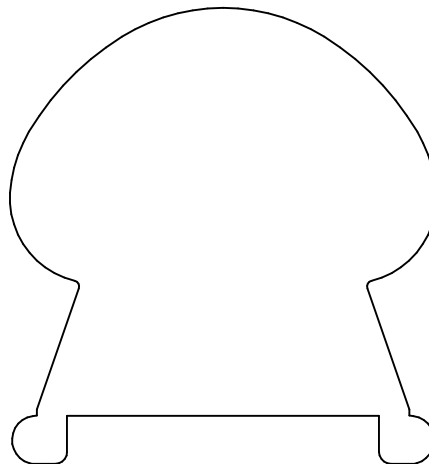

KL 7960P
2.375 x 2.220

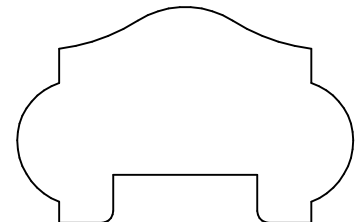

KL 7978P
1.125 x 1.750

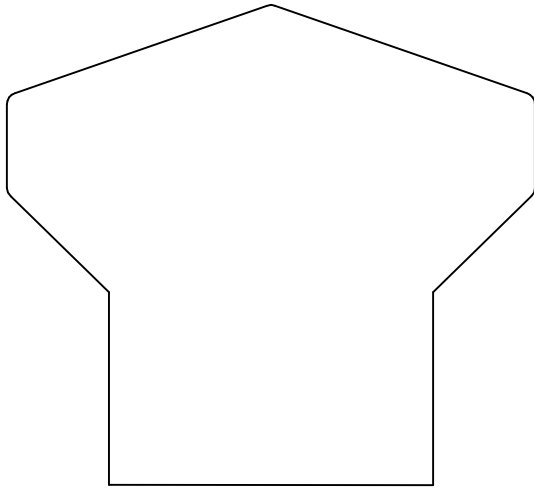

KL7961
2.500 x 2.750

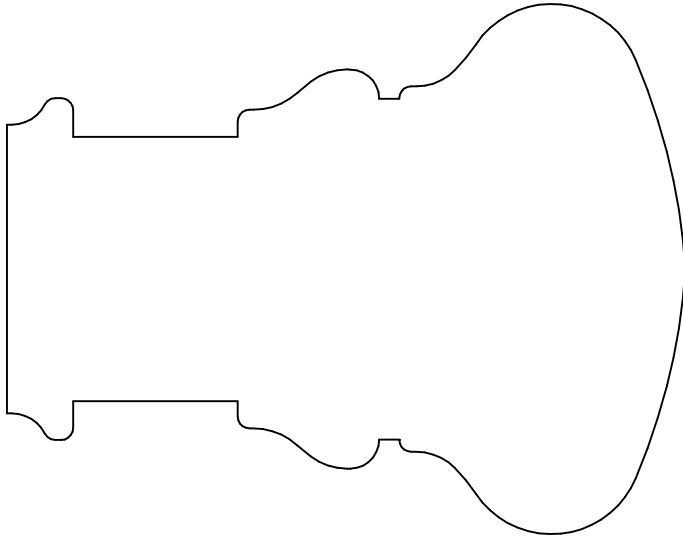

KL 7962
3.532 x 2.762

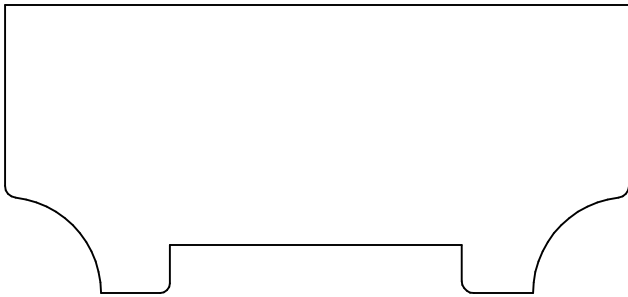

KL 7963P
1.500 x 3.250

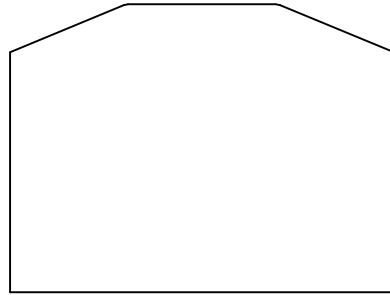

KL 7964
1.500 x 2.000

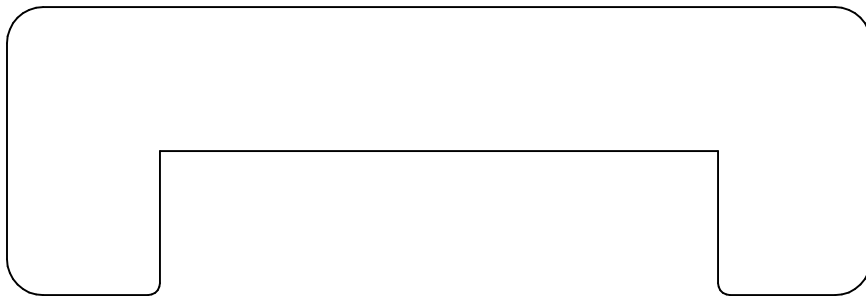

KL 7965P
1.500 x 4.500

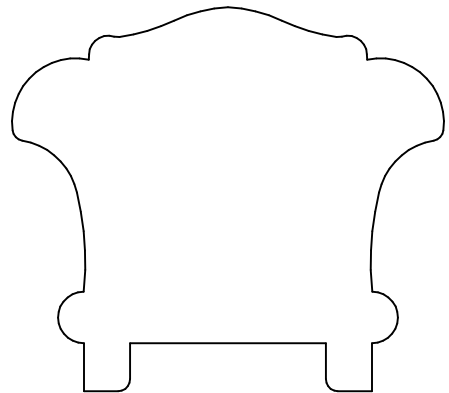

KL 7967P
2.000 x 2.250

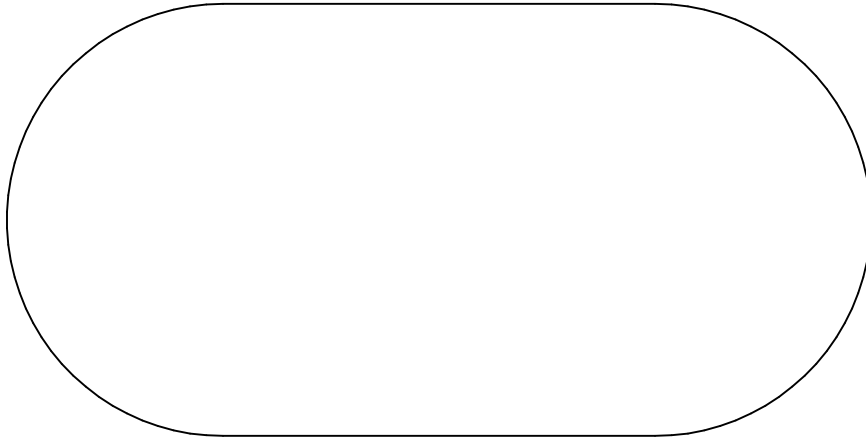

KL 7966
2.250 x 4.500

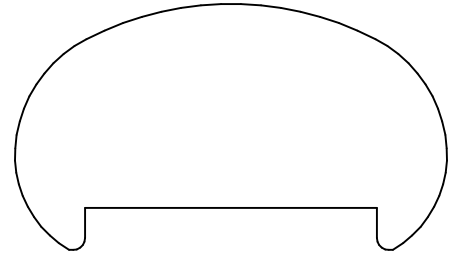

KL 7969P
1.281 x 2.250

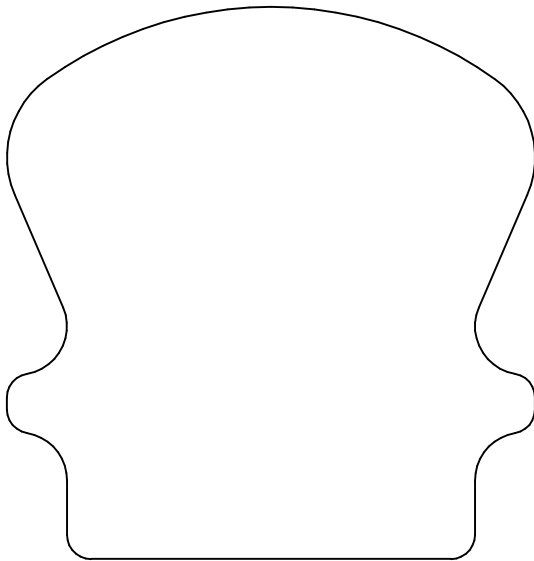

KL 7968
2.875 x 2.750

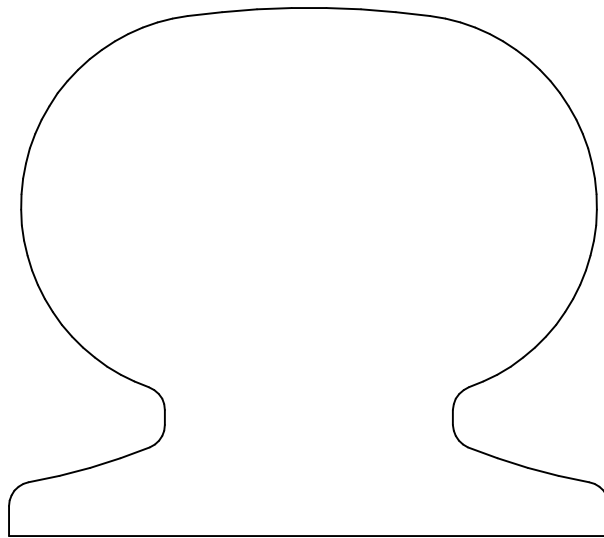

KL 7970
2.750 x 3.125

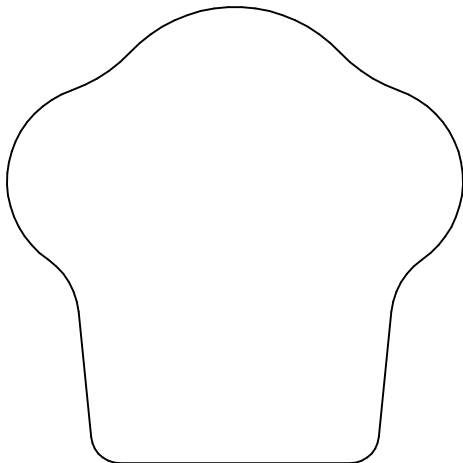

KL 7971
2.375 x 2.375

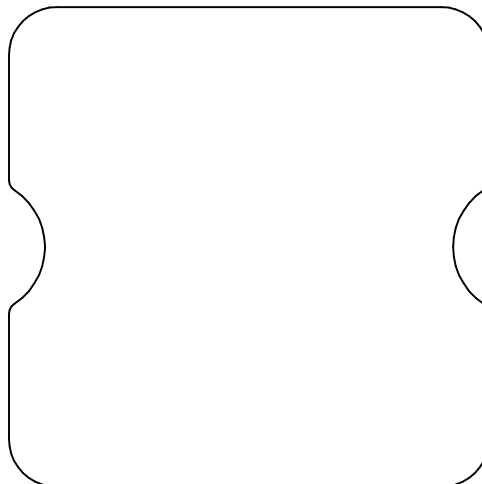

KL 7972
2.500 x 2.500

Keim
BUILT ON TRUST, SINCE 1911

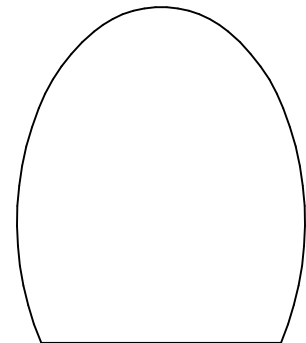

KL 7988
1.750 x 1.500

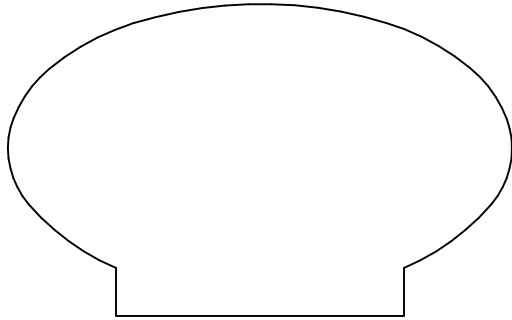

KL 7973
1.625 x 2.625

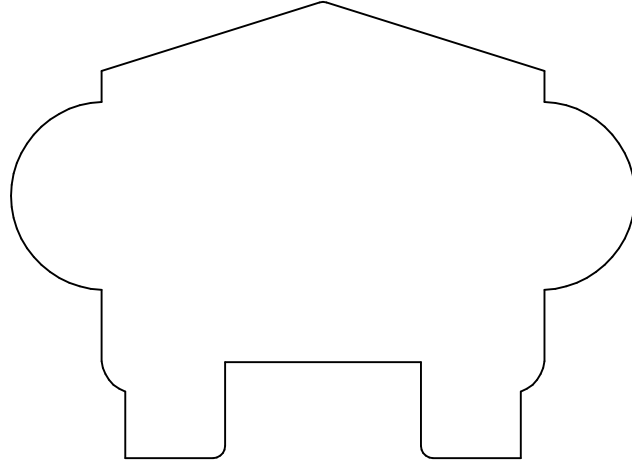

KL 7974P
2.375 x 3.250

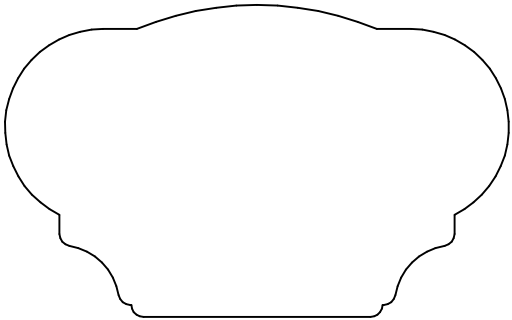

KL 7975
1.625 x 2.625

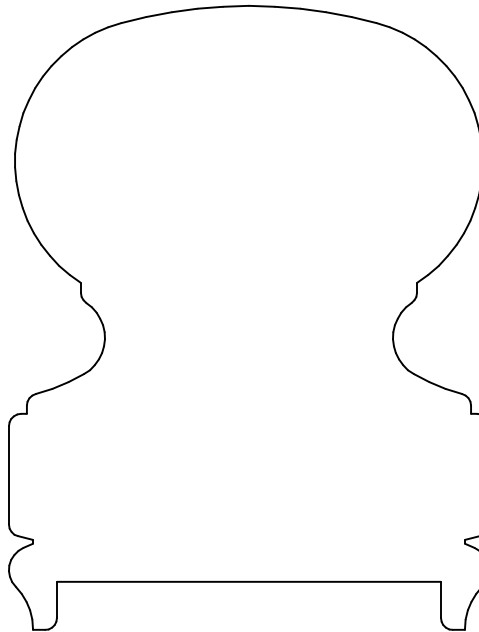

KL 7977P
3.250 x 2.500

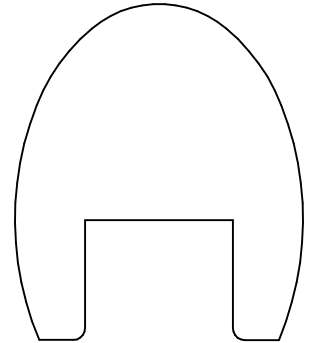

KL 7988P
1.750 x 1.500

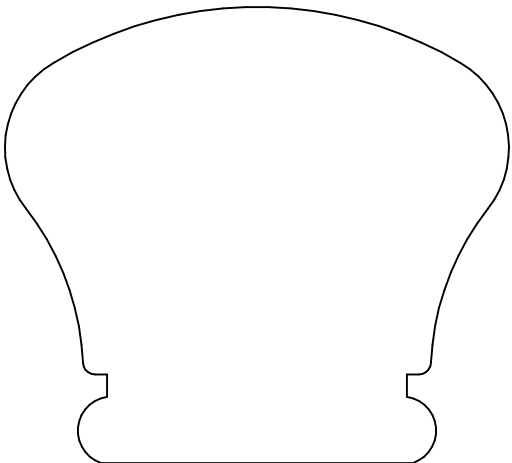

KL 7976
2.375 x 2.625

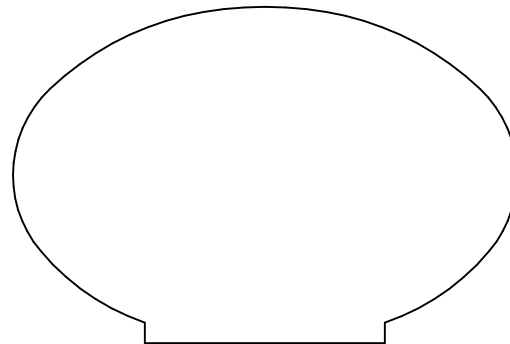

KL 7979
1.750 x 2.625

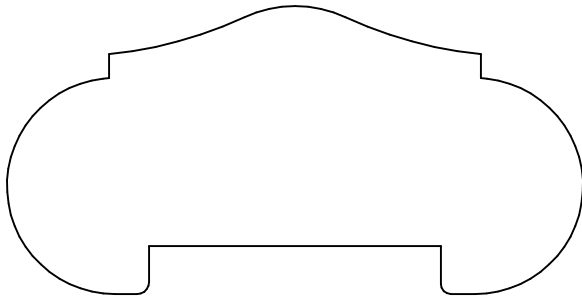

KL 7980P
1.500 x 3.000

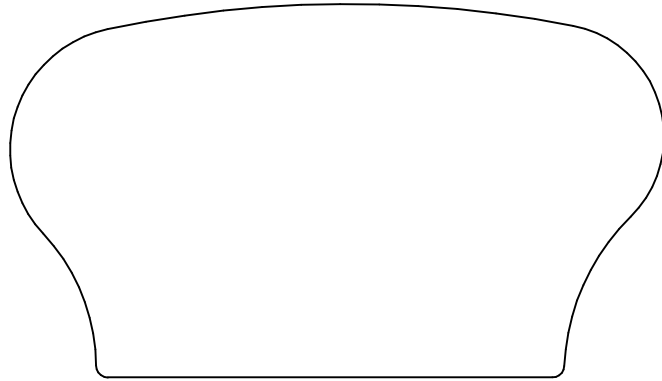

KL 7981
1.945 x 3.407

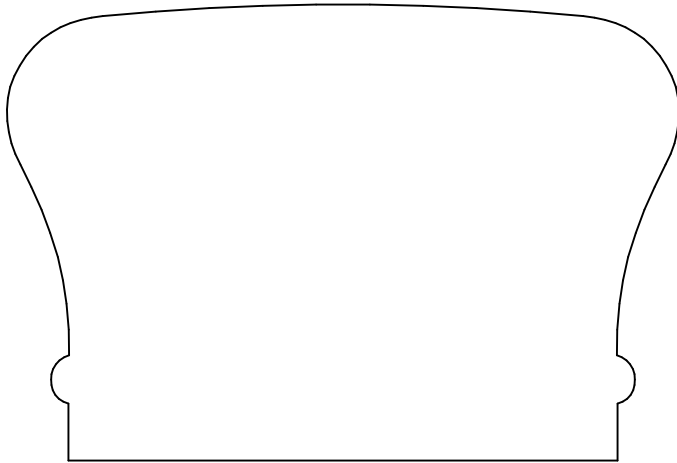

KL 7982
2.375 x 3.500



KL 7983P
1.562 x 2.750

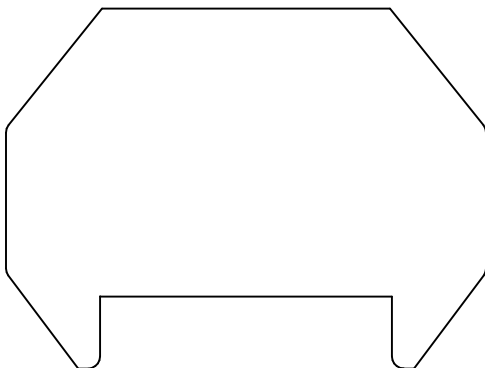

KL 7985P
1.875 x 2.500

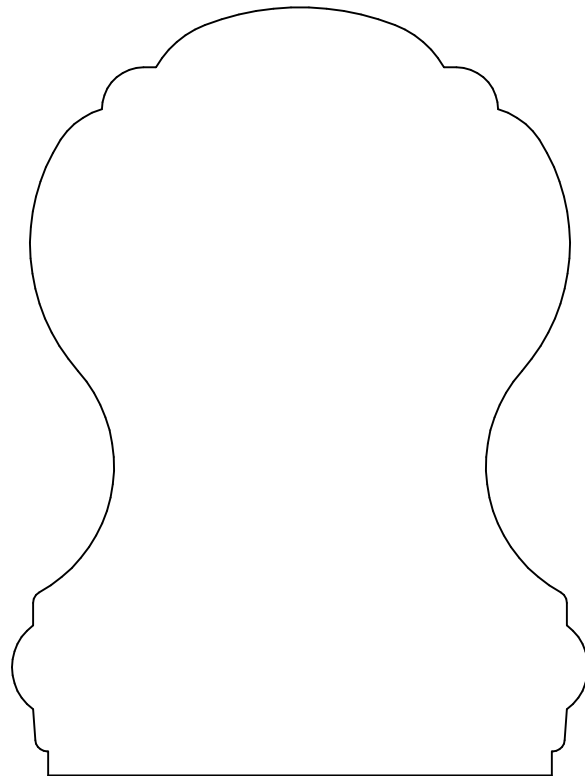

KL 7984
4.000 x 3.000

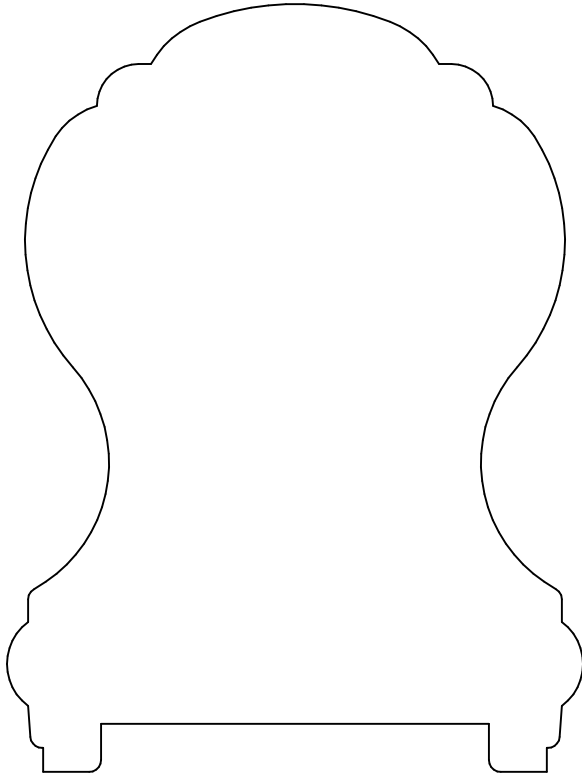

KL 7984P
4.000 x 3.000

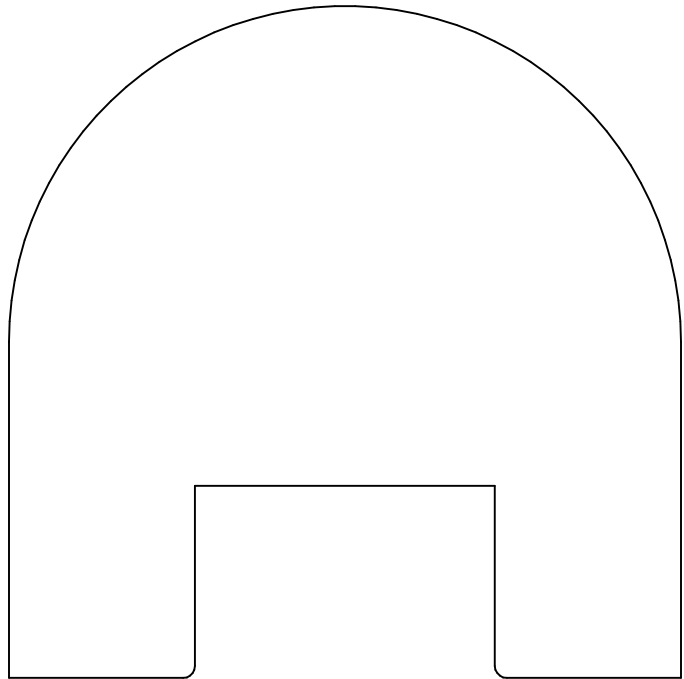

KL 7986P
3.500 x 3.500

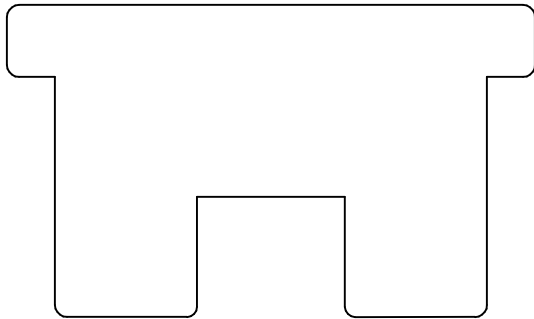

KL 7987P
1.625 x 2.750

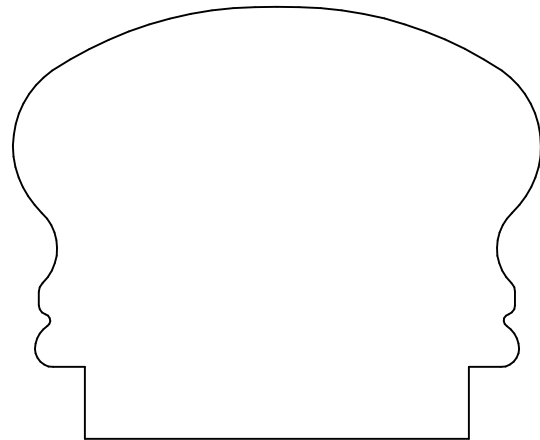

KL 7989
2.250 x 2.750

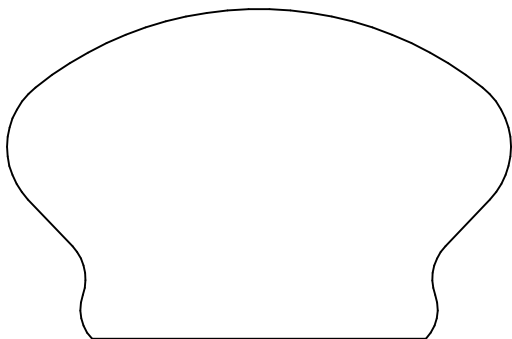

KL 7992
1.718 x 2.625

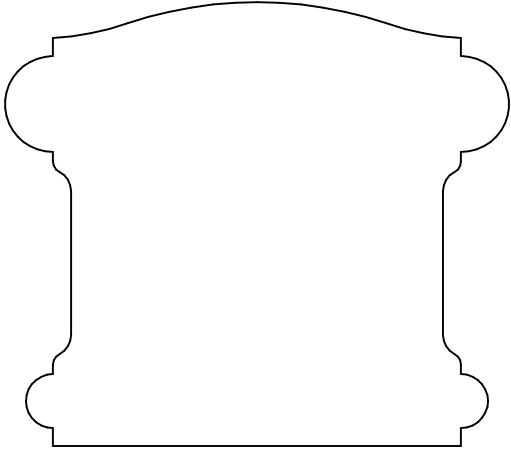

KL 7990
2.312 x 2.625

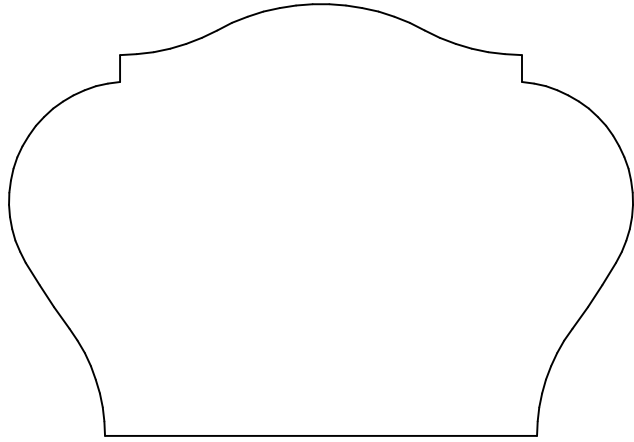

KL 7993
2.250 x 3.250

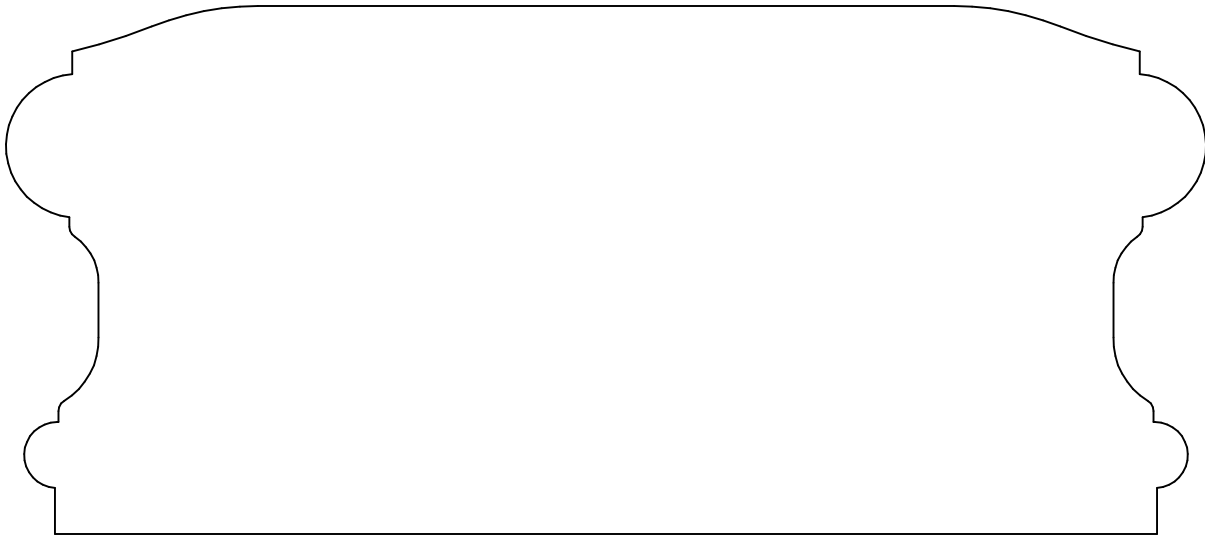

KL 7991
2.750 x 6.250

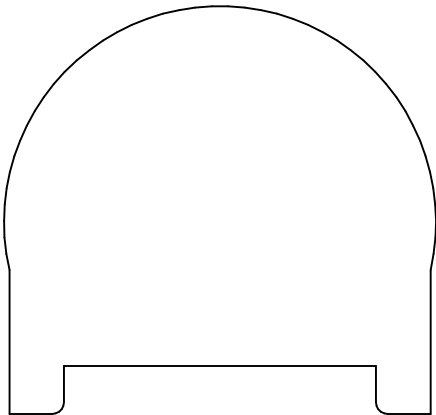

KL 7994 P
2.125 x 2.250

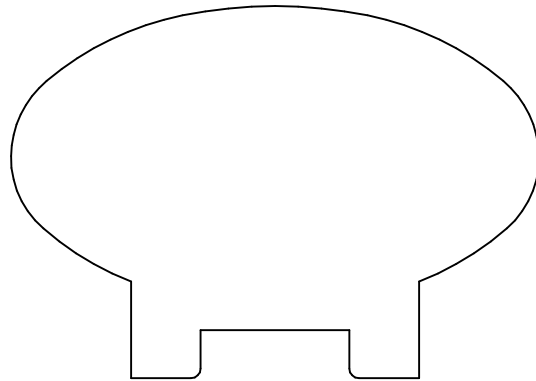

KL 7996P
1.938 x 2.750



KL 7991P
2.750 x 6.250

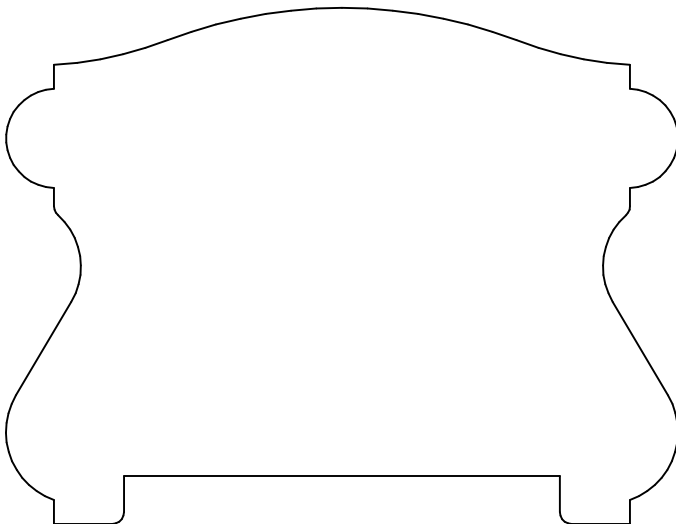

KL 7995P
2.687 x 3.500

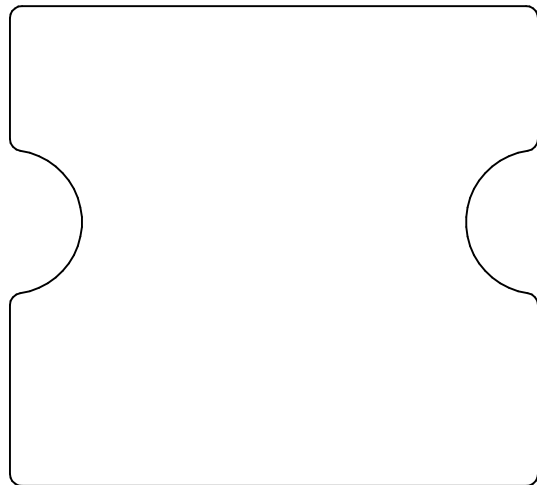

KL 7997
2.500 x 2.750

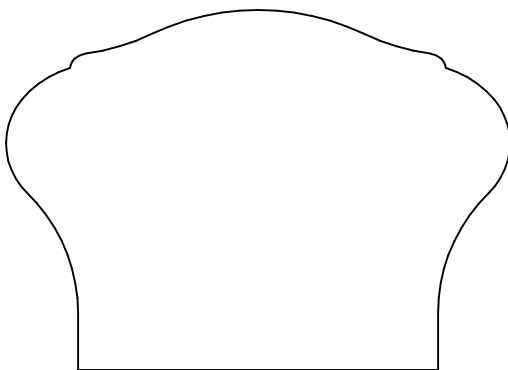

KL 7999
1.875 x 2.625

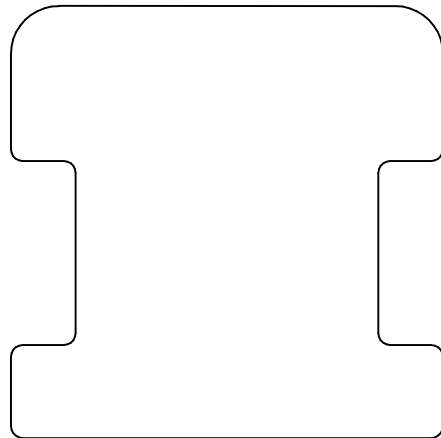

KL 7998
2.250 x 2.250

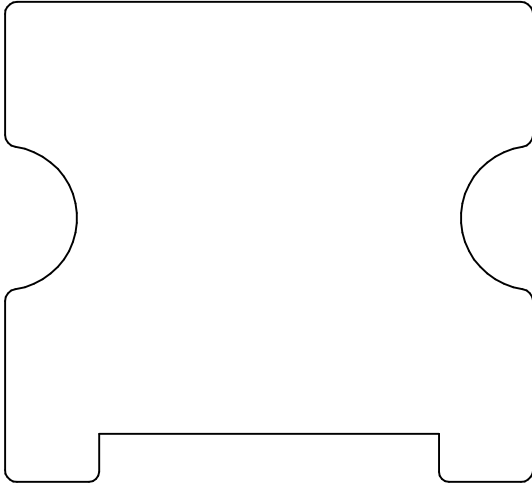

KL 7997P
2.500 x 2.750

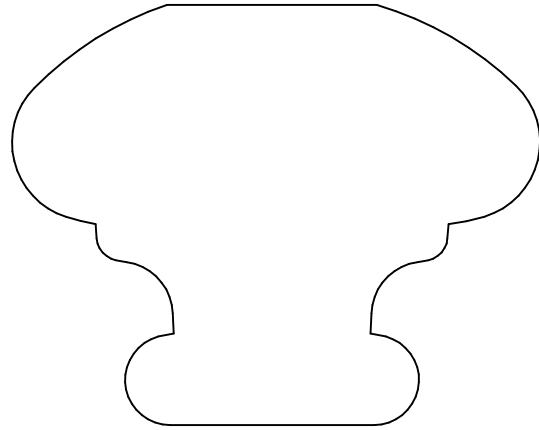

KL 9903
2.187 x 2.750

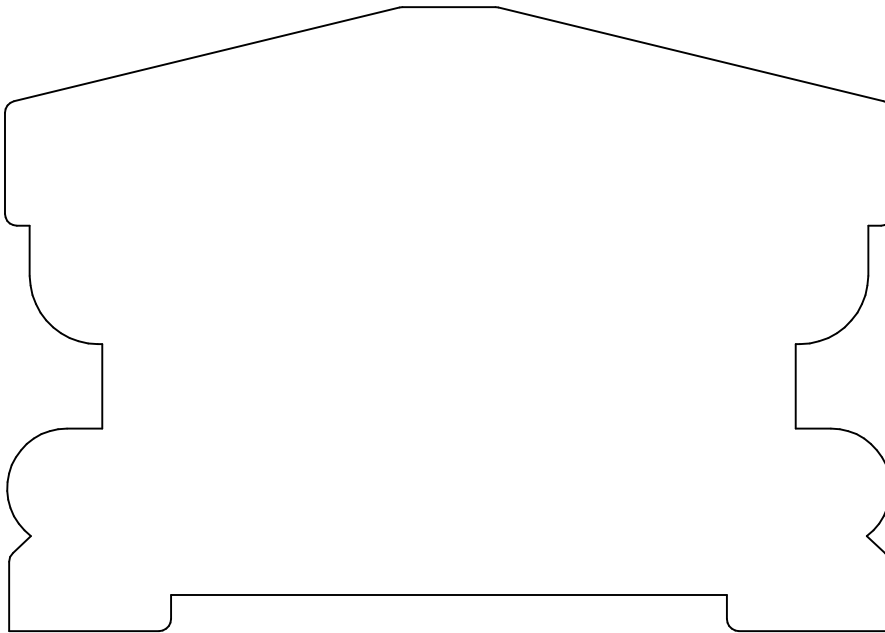

KL 9900P
3.250 x 4.625

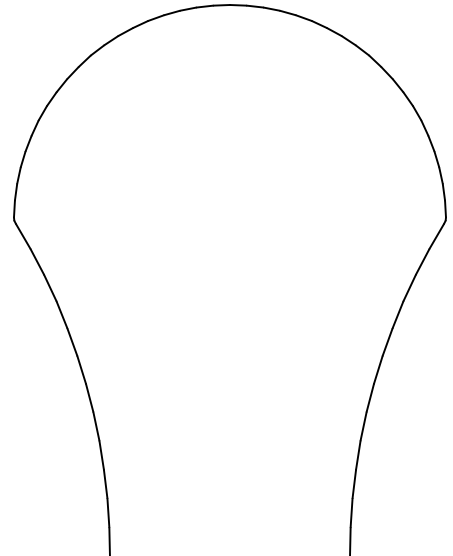

KL 9904
2.875 x 2.250

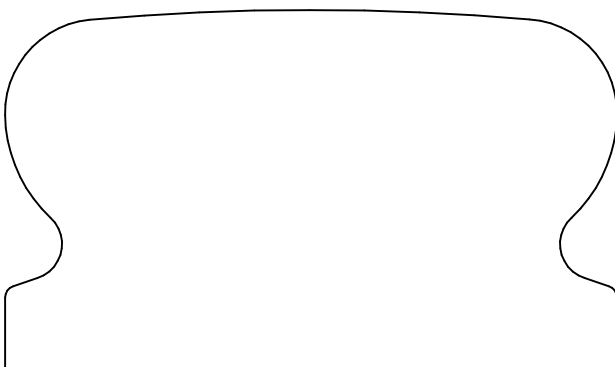

KL 9905
1.875 x 3.188

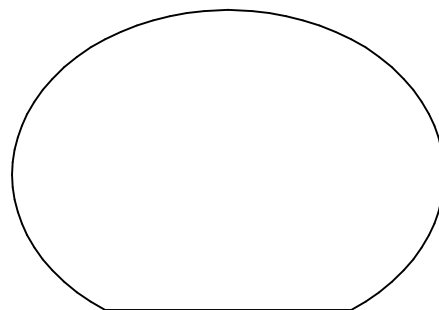

KL 9910
1.562 x 2.250

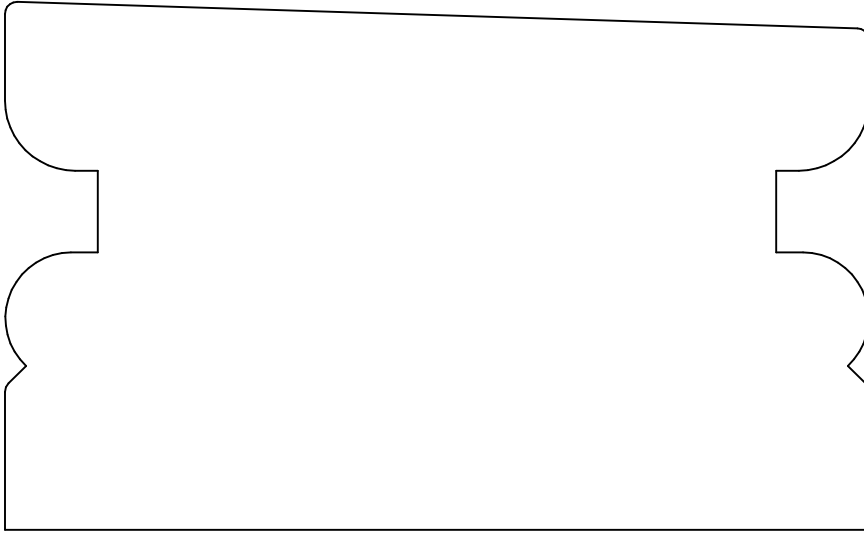

KL 9901
2.750 x 4.500

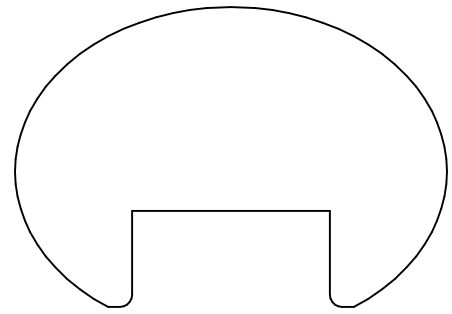

KL 9910P
1.562 x 2.250

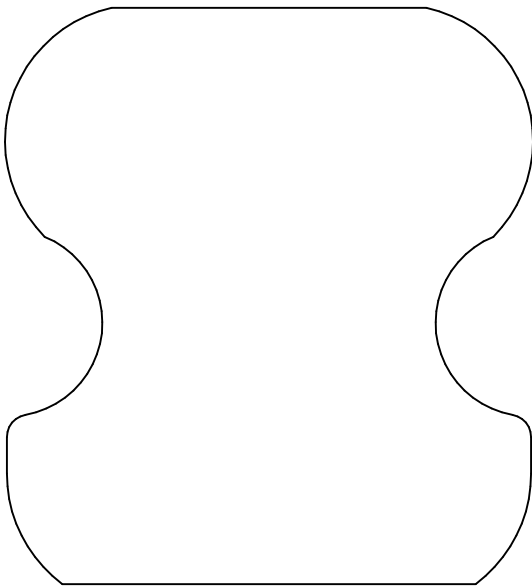

KL 9902
3.000 x 2.750

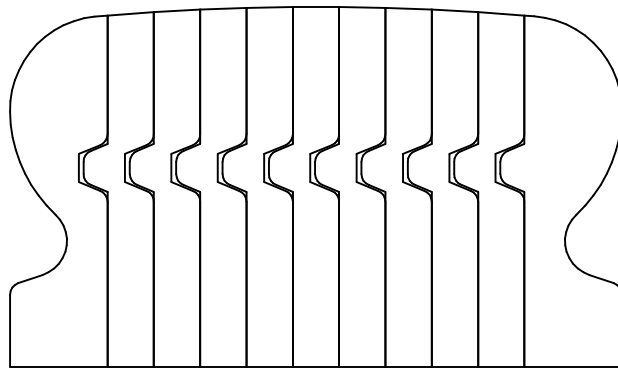

KL 9905B
2.500 x 3.500

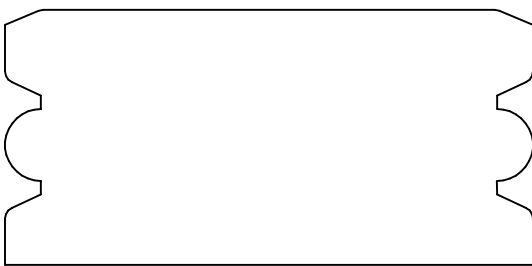

KL 9914
1.328 x 2.750

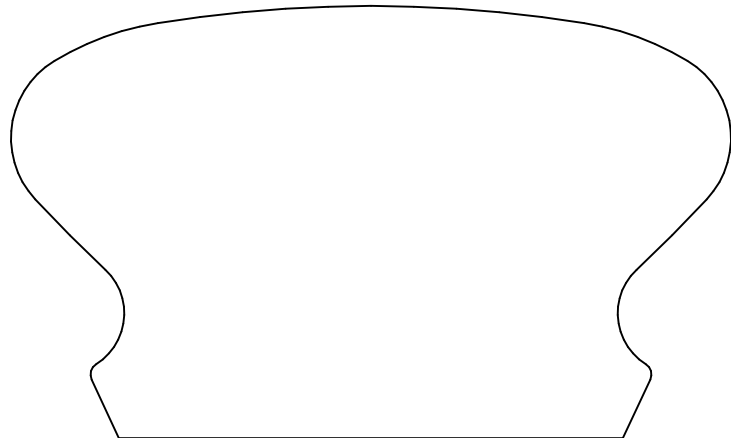

KL 9906
2.250 x 3.750

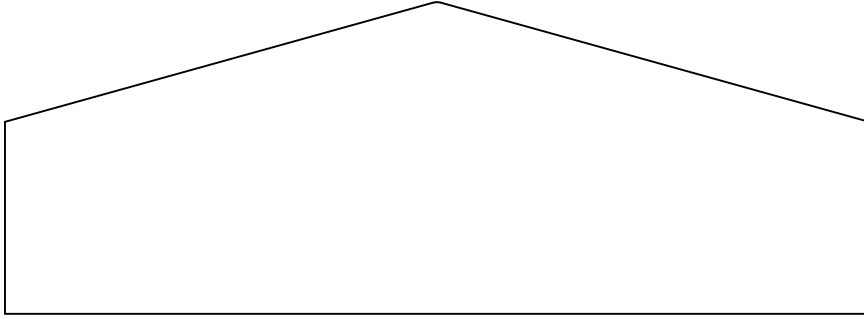

KL 9907
1.625 x 4.500

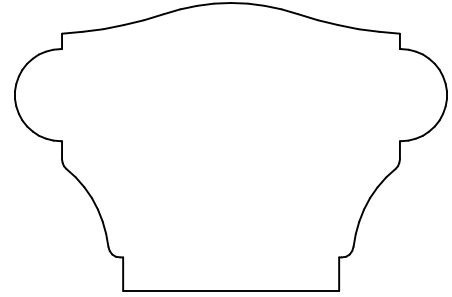

KL 9916
1.500 x 2.250

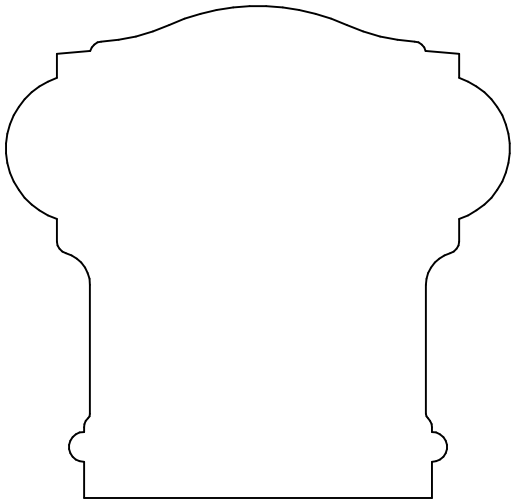

KL 9908
2.562 x 2.625

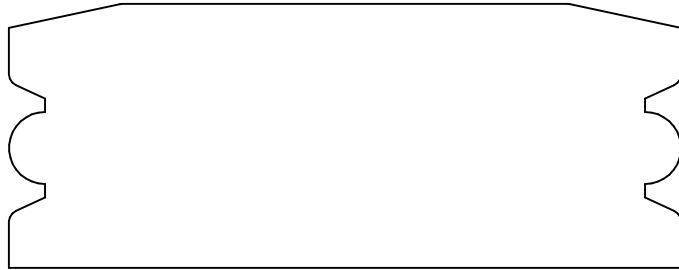

KL 9913
1.375 x 3.500

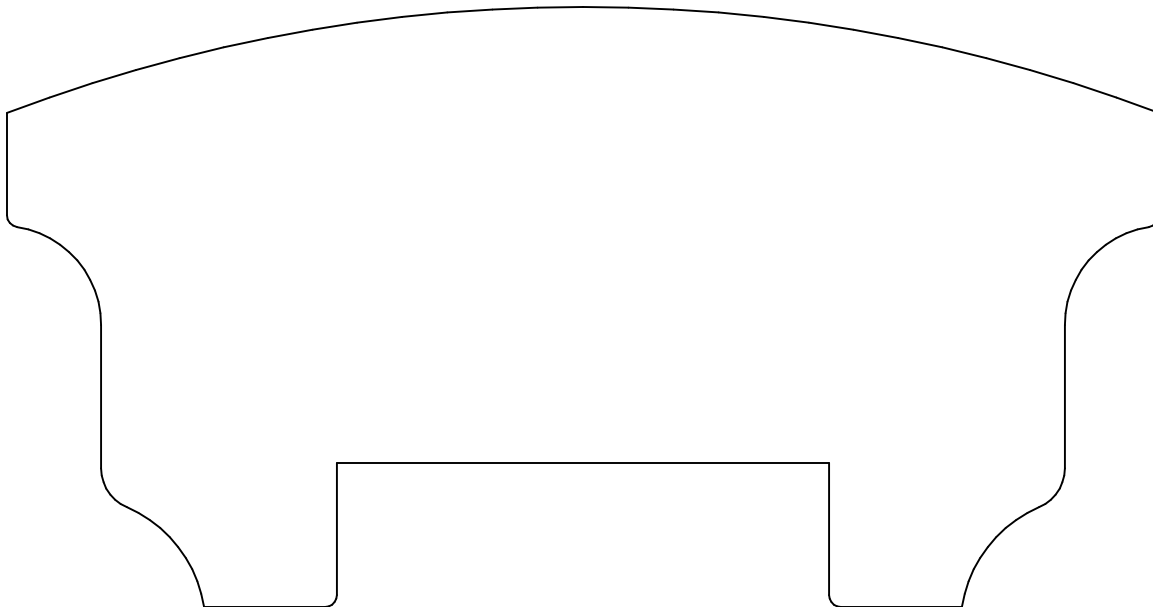

KL 9909
3.125 x 6.000

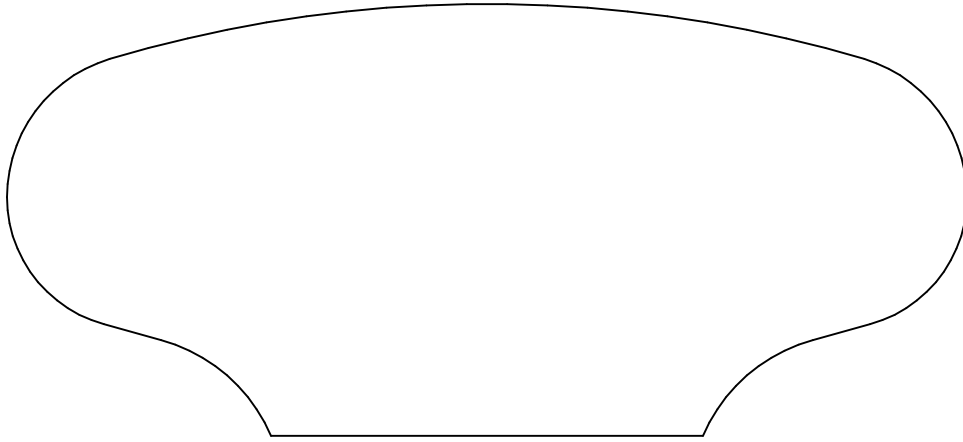

KL 9911
2.250 x 5.000

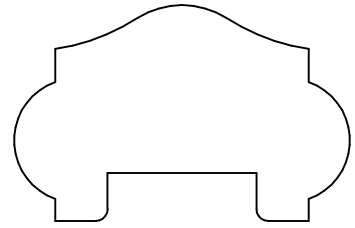

KL 9920 P
1.125 x 1.750

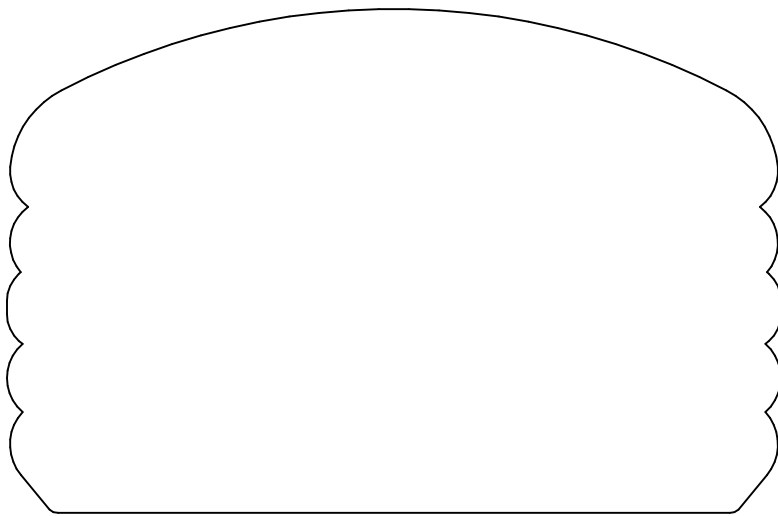

KL 9912
2.625 x 4.031

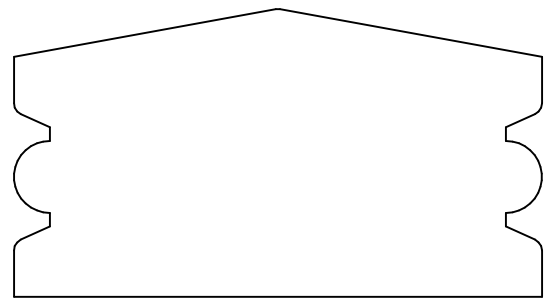

KL 9915
1.500 x 2.750

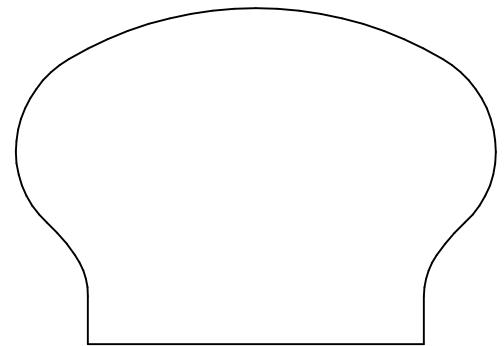

KL 9921
1.750 x 2.500

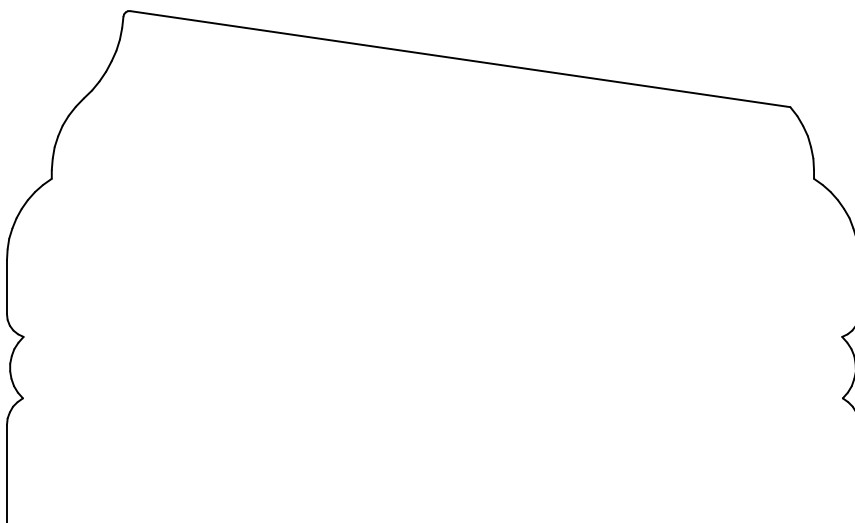

KL 9917
2.688 x 4.437

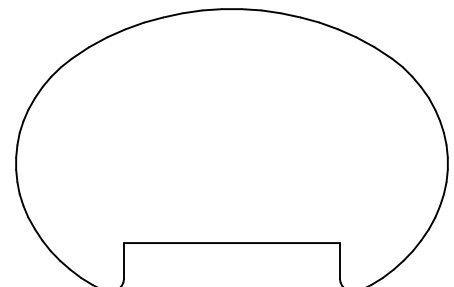

KL 9924P
1.469 x 2.250

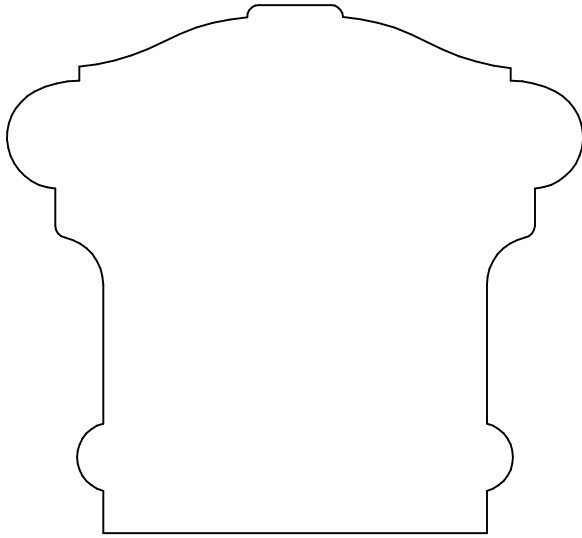

KL 9918
2.750 x 3.000

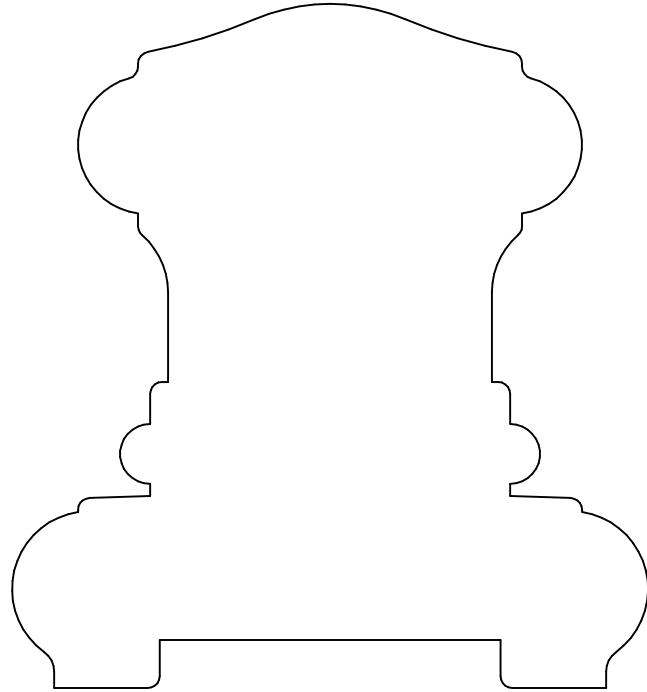

KL 9919 P
3.562 x 3.313

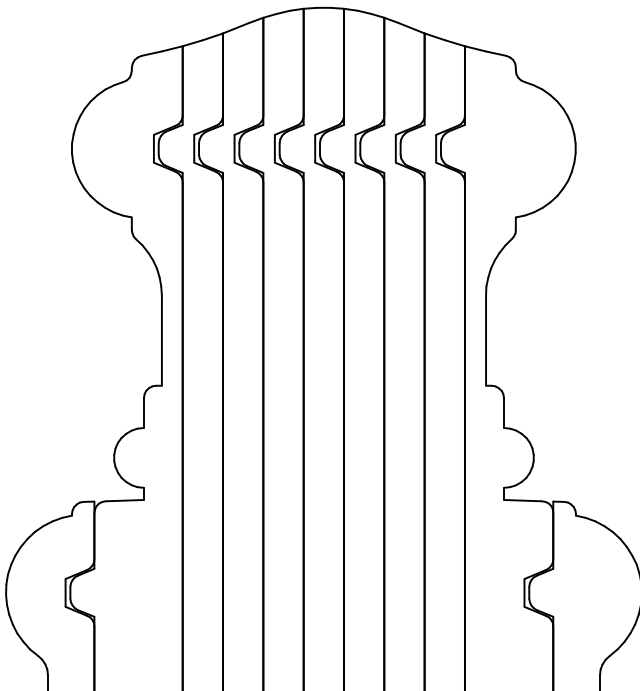

KL 9919B
2.500 x 3.500

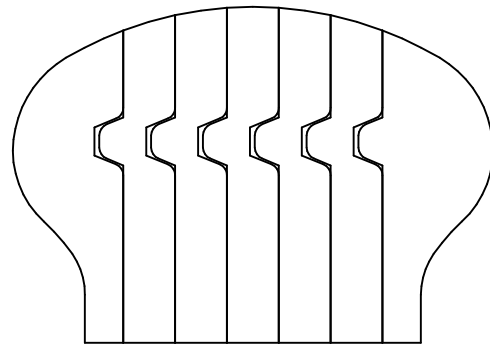

KL 9921B
1.750 x 2.500

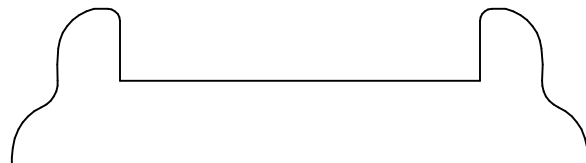

KL 9930
.813 x 3.000

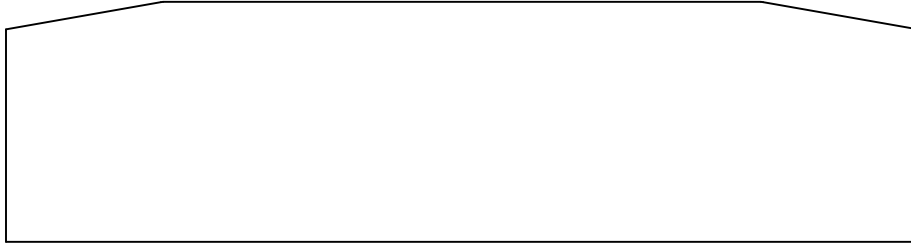

KL 9922
1.250 x 4.750

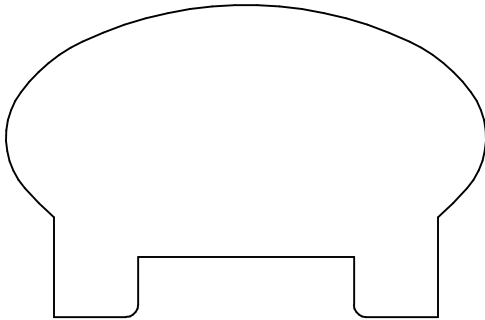

KL 9923P
1.625 x 2.500

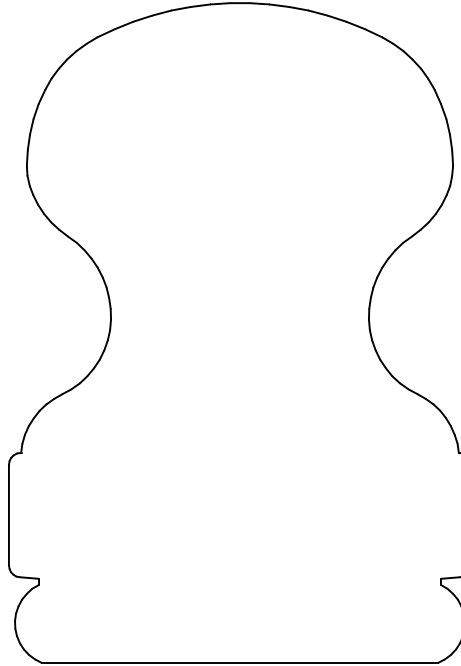

KL 9925
3.437 x 2.406

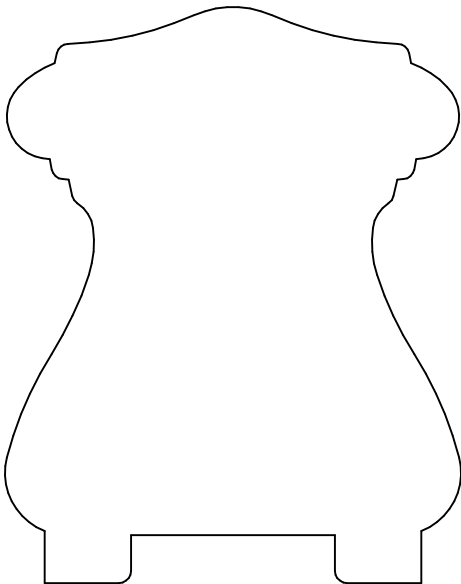

KL 9926P
3.000 x 2.375

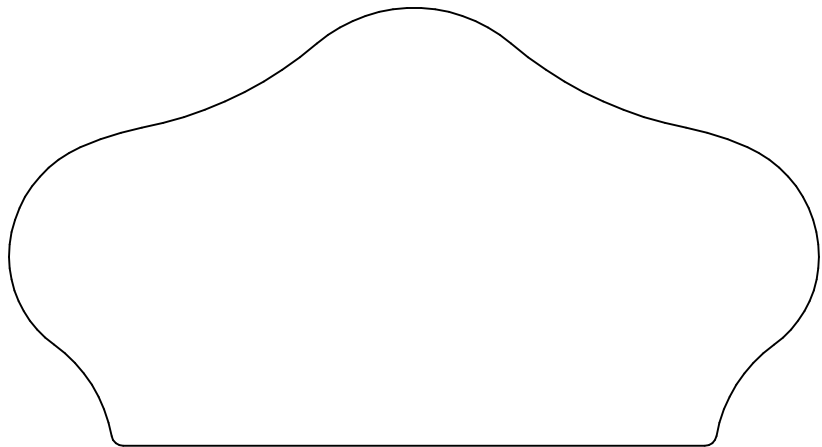

KL 9927
2.281 x 4.219

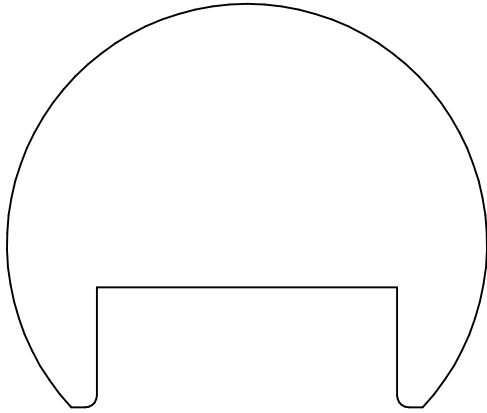

KL 9928P
2.101 x 2.500

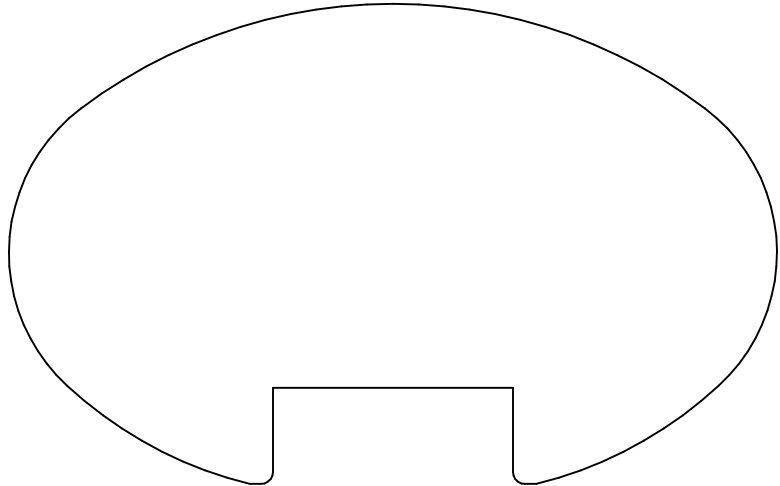

KL 9929P
2.500 x 4.000

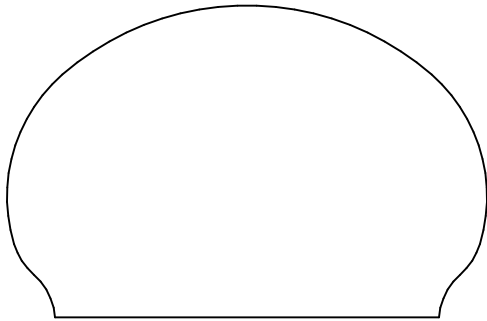

KL 9931
1.625 x 2.500

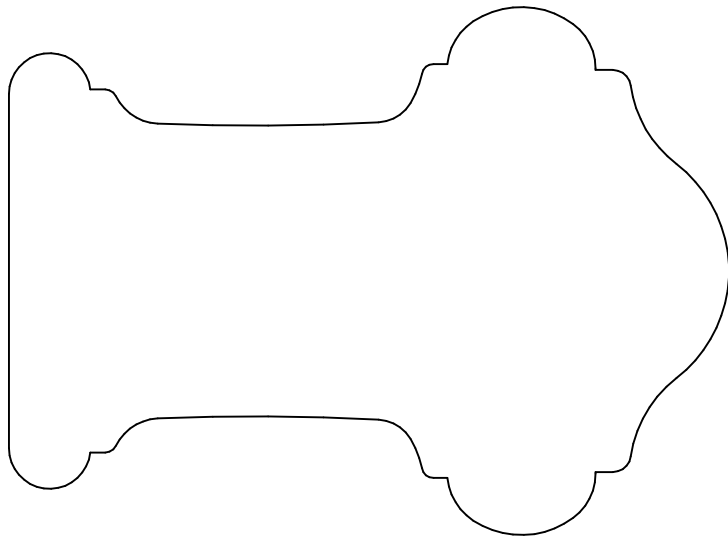

KL 9932
2.750 x 3.750

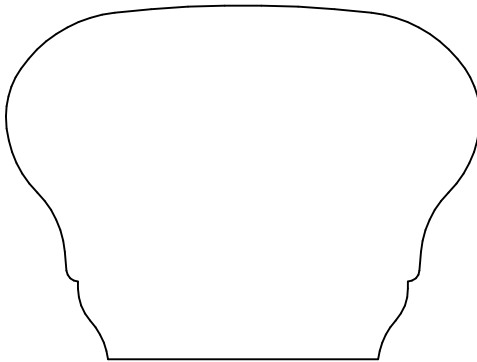

KL 9935
1.844 x 2.469

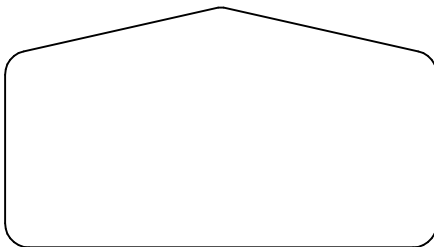

KL 9945
1.250 x 2.250

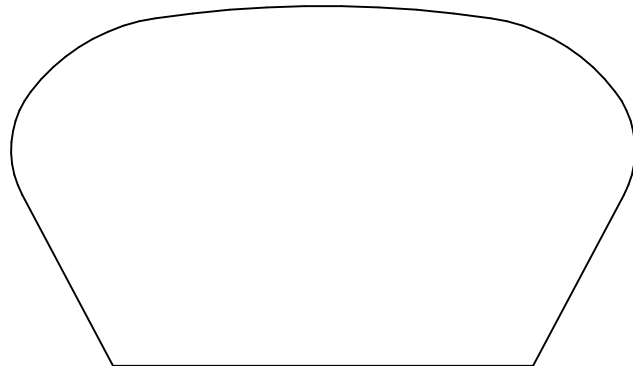

KL 9936
1.875 x 3.250

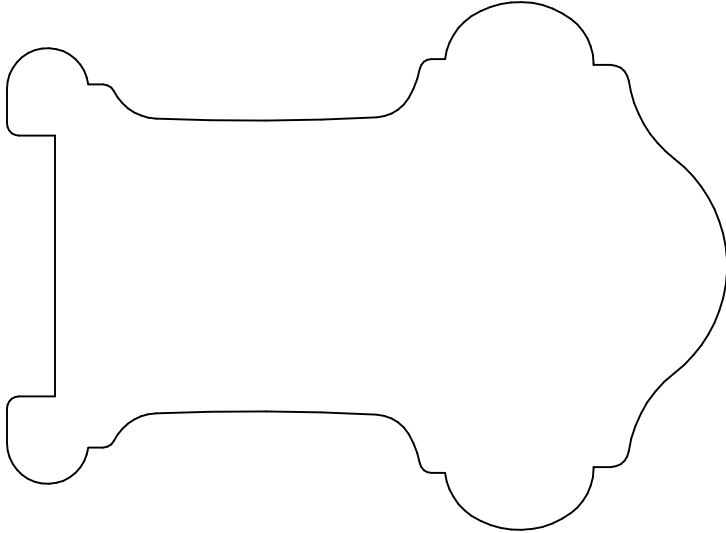

KL 9932P
2.750 x 3.750

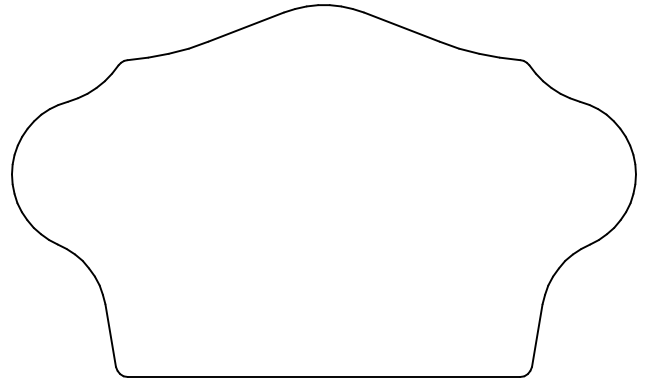

KL 9938
1.938 x 3.250

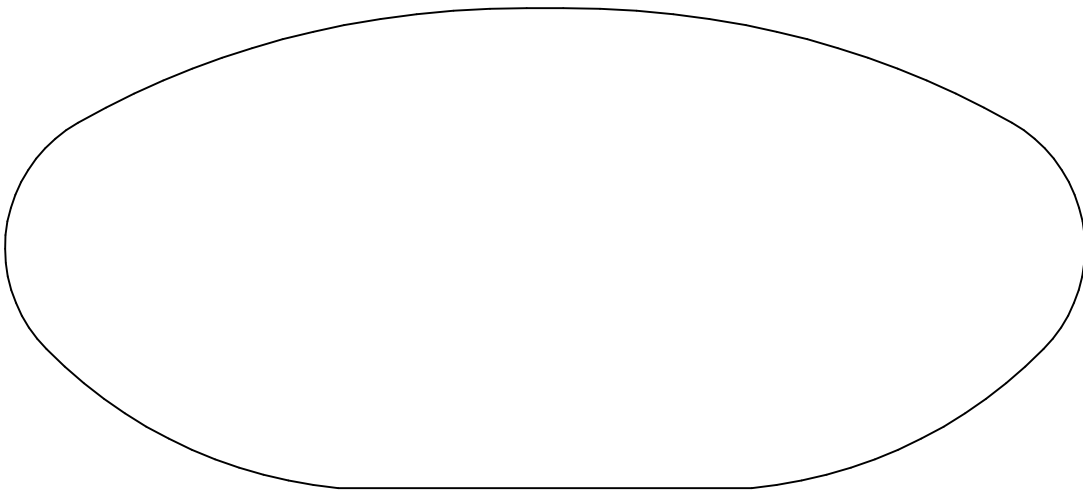

KL 9933
2.500 x 5.625

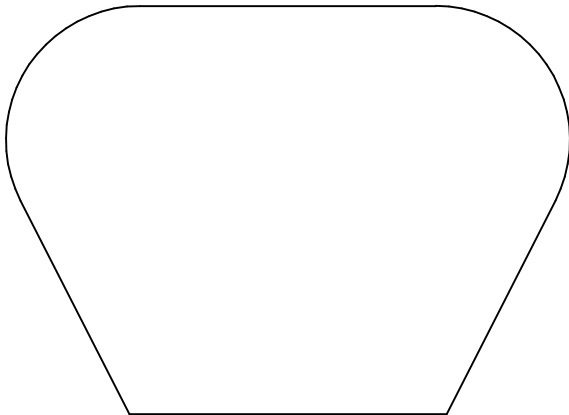

KL 9939
2.125 x 2.938

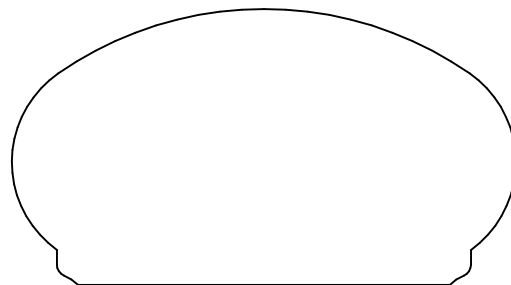

KL 9940
1.438 x 2.625

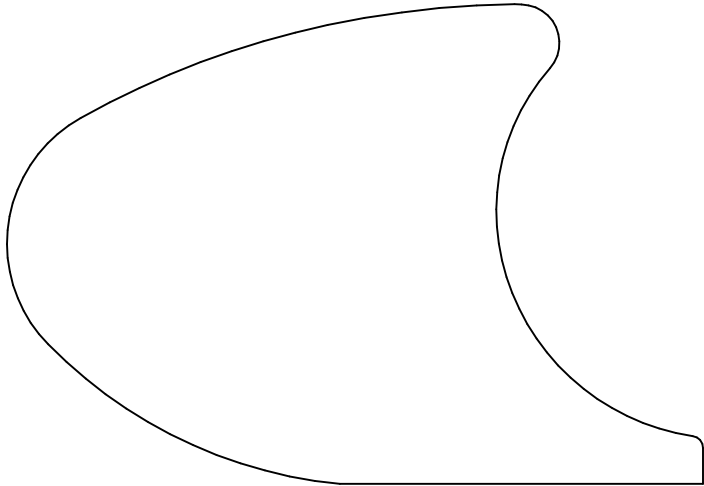

KL 9934
2.500 x 3.625

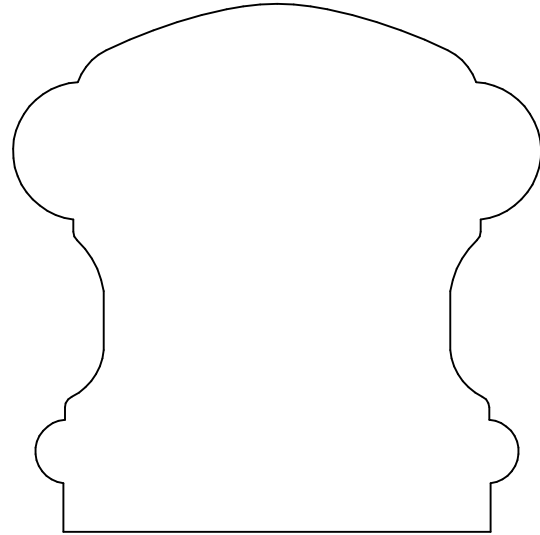

KL 9941
2.750 x 2.750

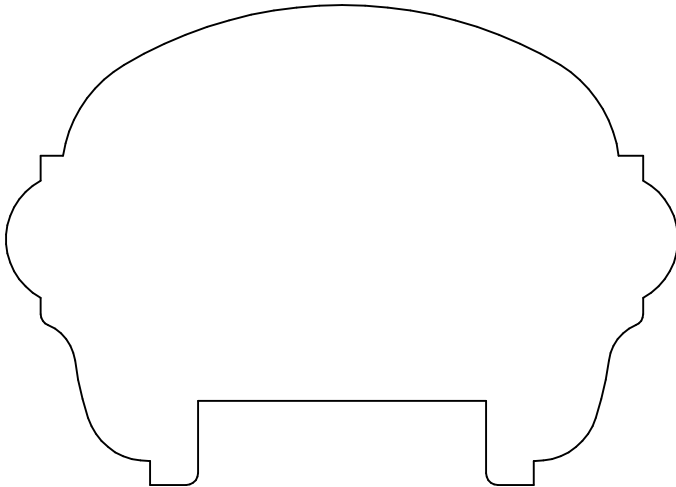

KL 9937P
2.500 x 3.500

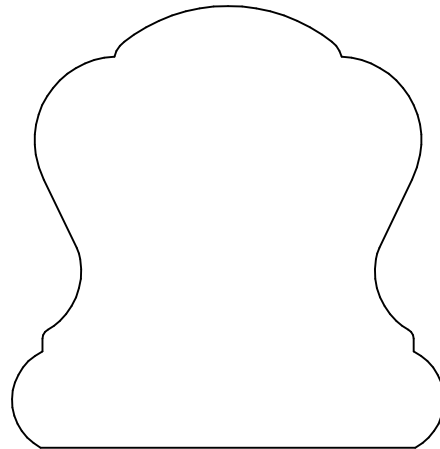

KL 9942
2.300 x 2.250

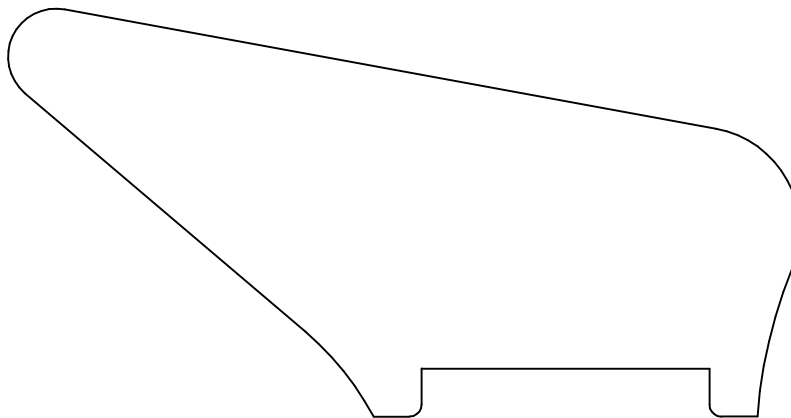

KL 9943P
2.125 x 4.125

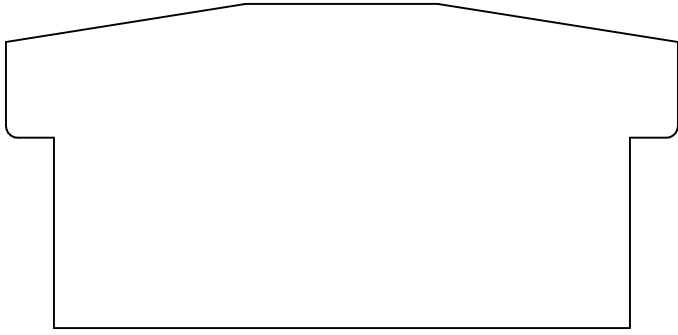

KL 9944
1.688 x 3.500

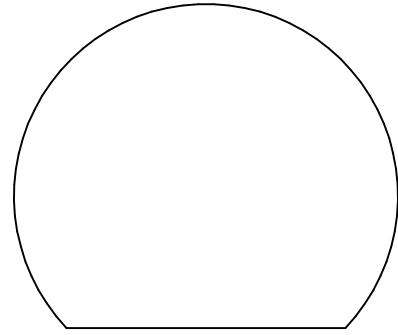

KL 9947
1.687 x 2.000

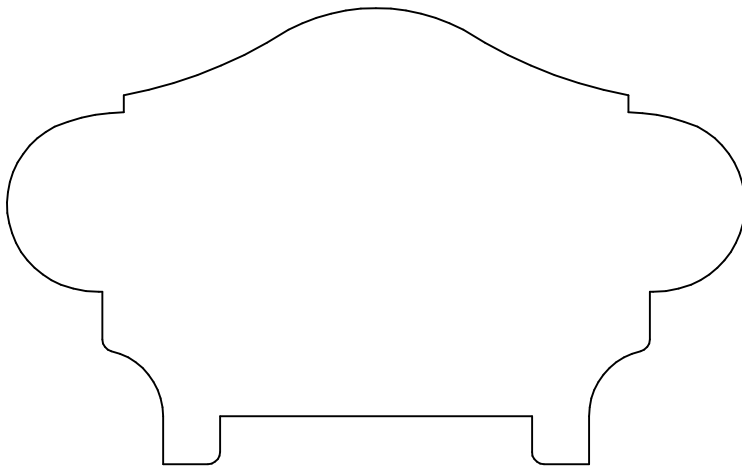

KL 9946P
2.375 x 3.844

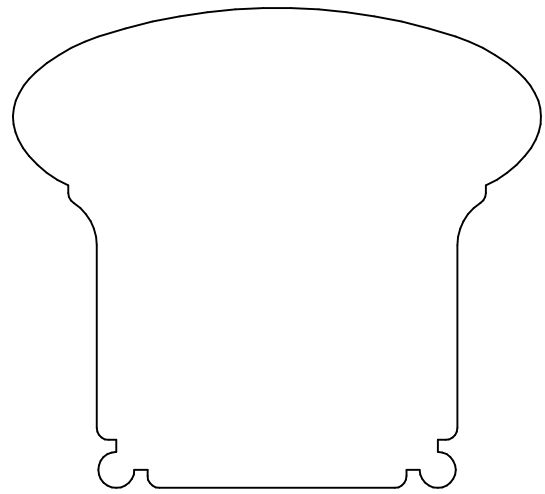

KL 9949
2.500 x 2.750

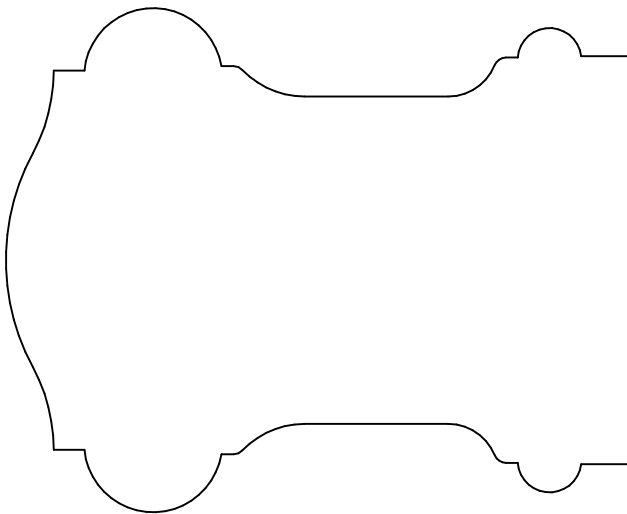

KL 9948
3.250 x 2.625

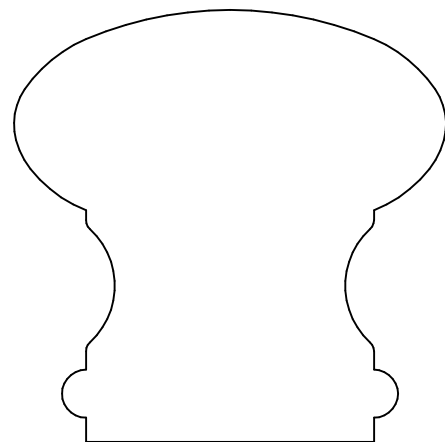

KL 9950
2.250 x 2.250

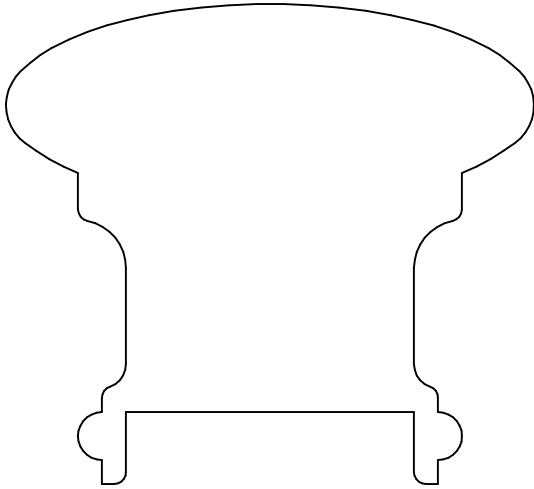

KL 9951P
2.500 x 2.750

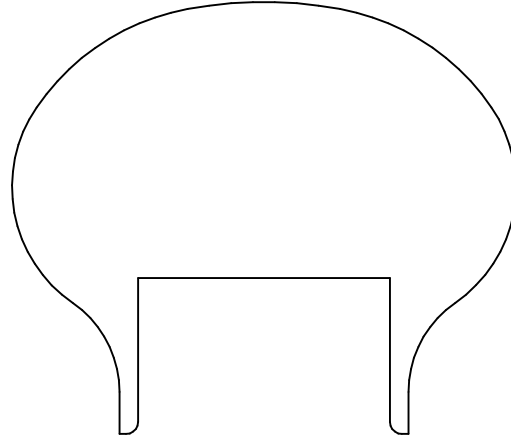

KL 9952P
2.250 x 2.625

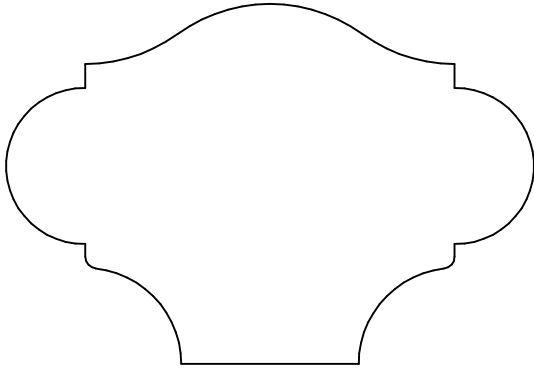

KL 9953
1.875 x 2.750

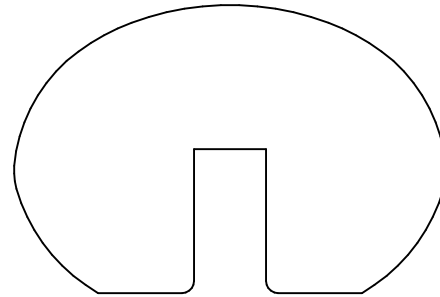

KL 9954P
1.500 x 2.250

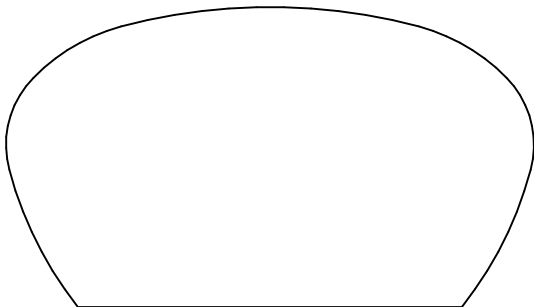

KL 9955
1.562 x 2.750

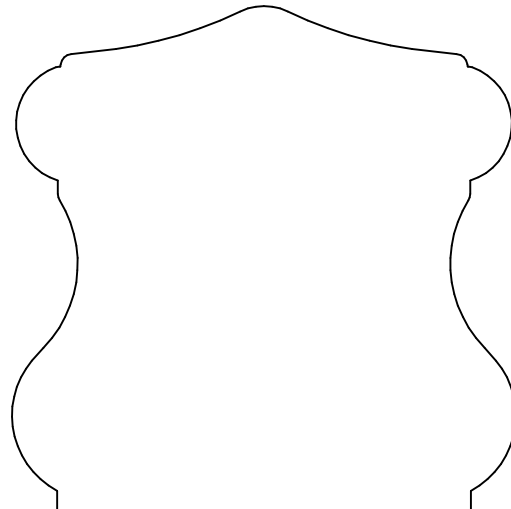

KL 9956
2.625 x 2.625

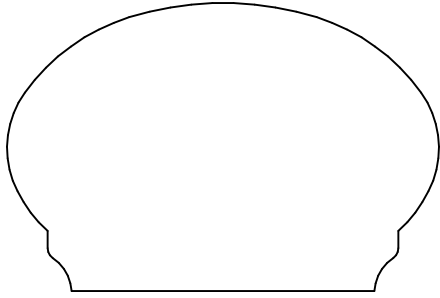

KL 9957
1.500 x 2.250

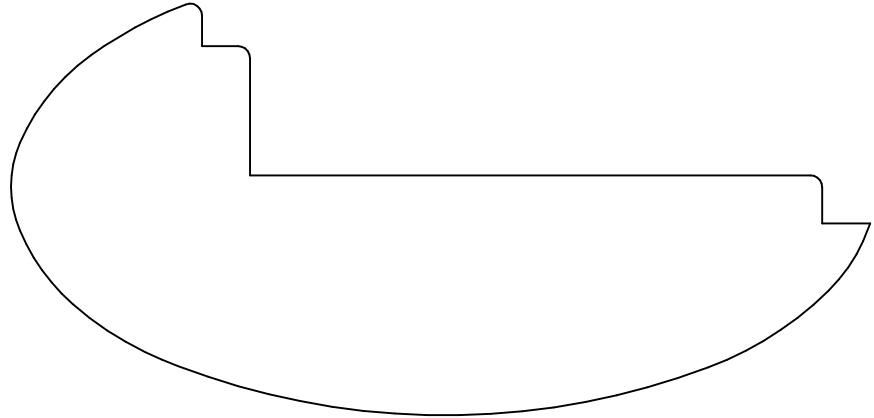

KL 9958
2.140 x 4.475

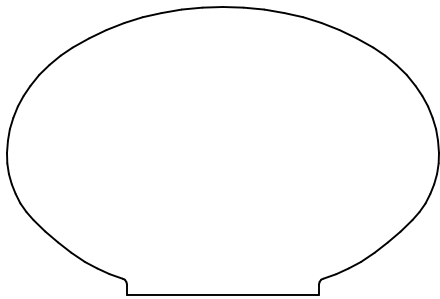

KL 9959
1.500 x 2.250

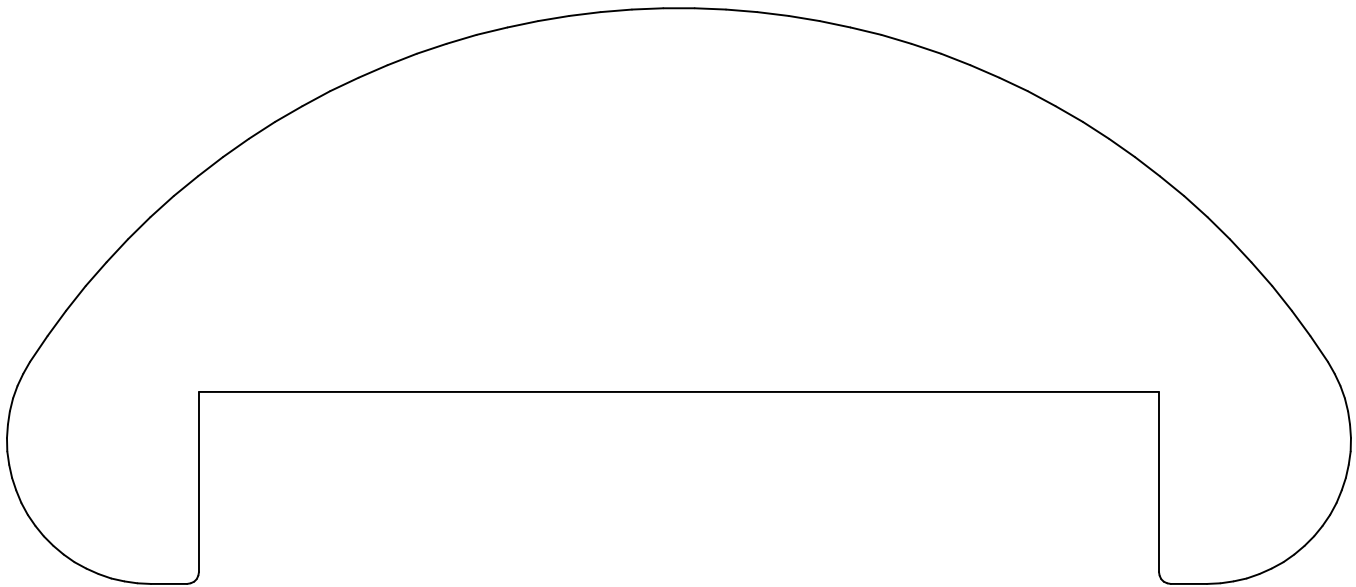

KL 9960P
3.000 x 7.000

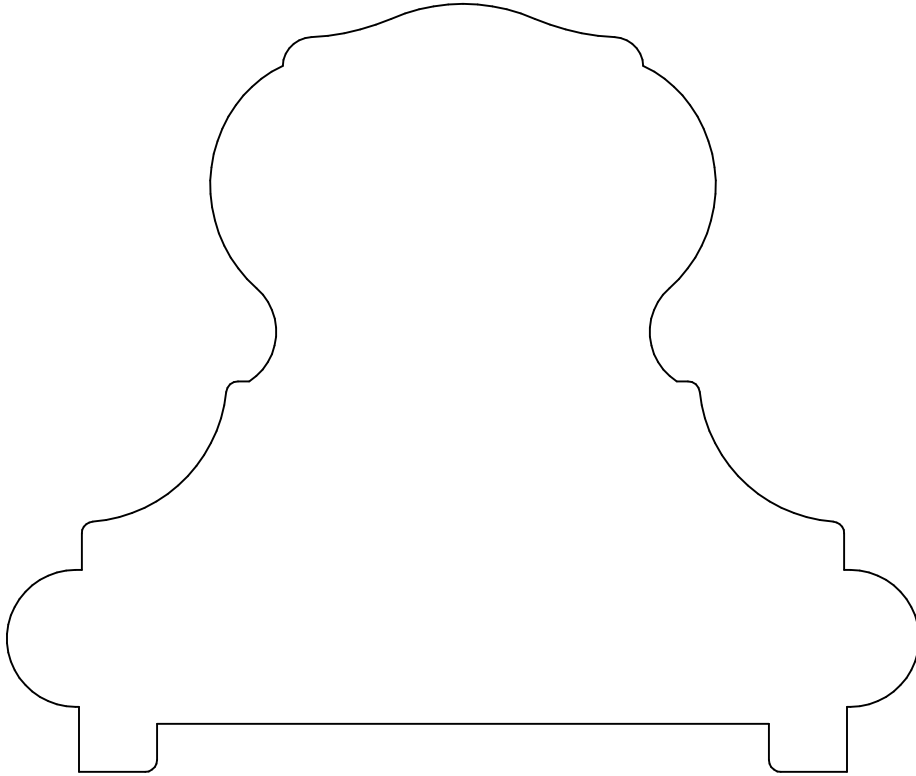

KL 9961P
4.000 x 4.750

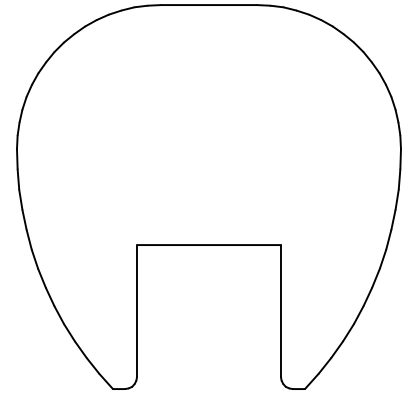

KL 9968P
2.000 x 2.000

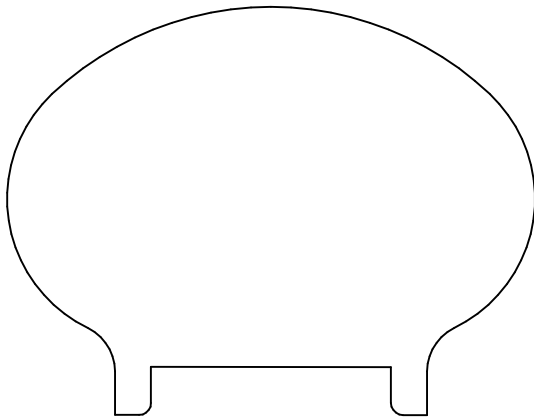

KL 9962P
2.125 x 2.750

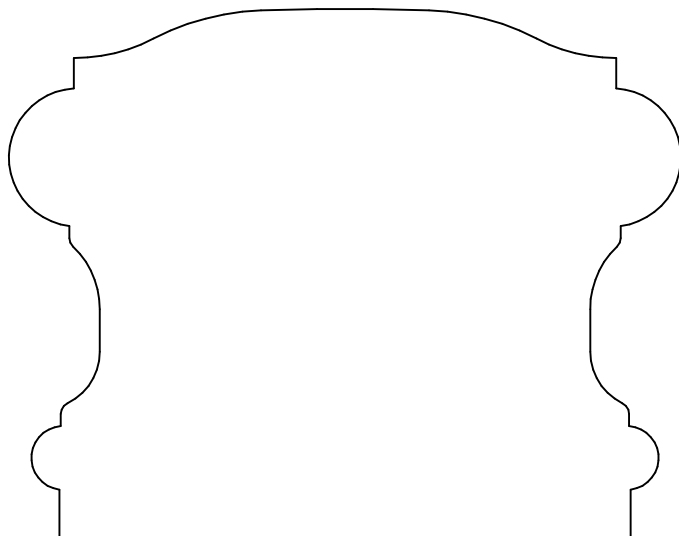

KL 9963
2.750 x 3.500

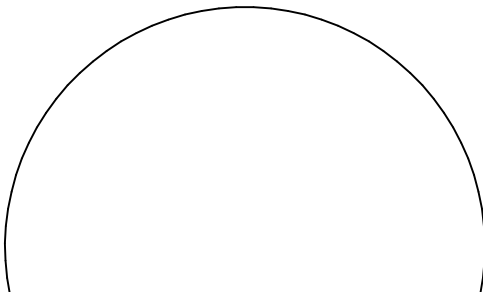

KL 9974P
1.500 x 2.500

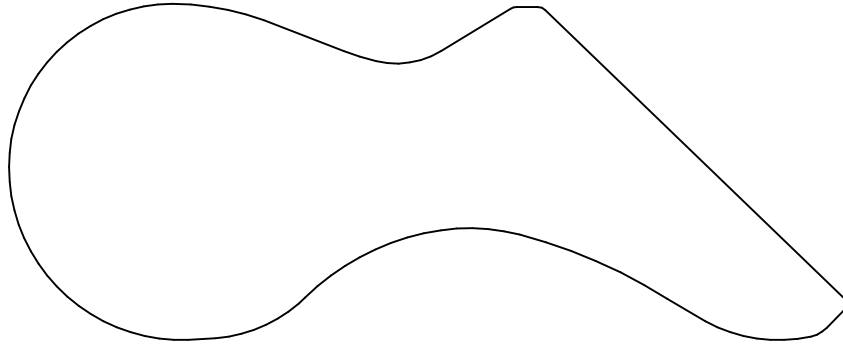

KL 9964
1.750 x 4.380

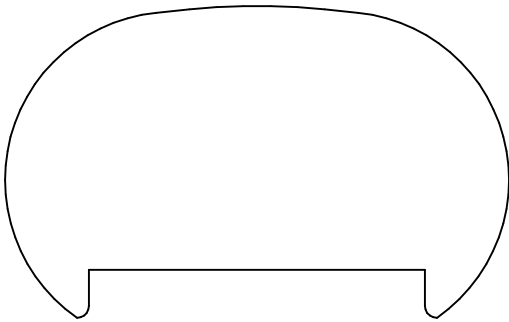

KL 9965P
1.624 x 2.625

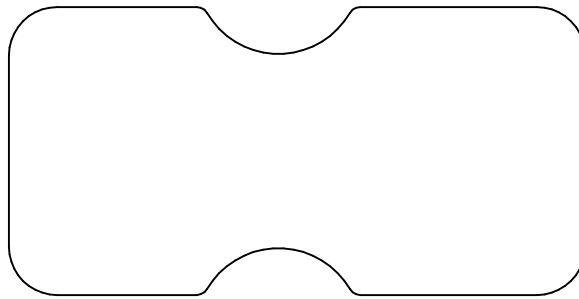

KL 9976
1.500 x 3.000



KL 9966
2.062 x 4.500

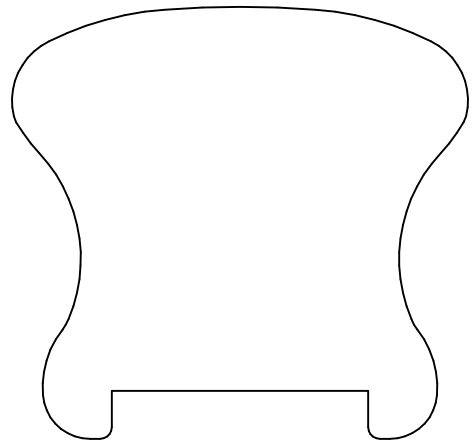

KL 9977P
2.250 x 2.375

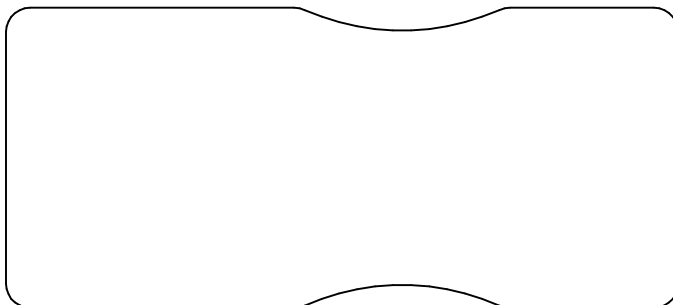

KL 9984
1.563 x 3.500

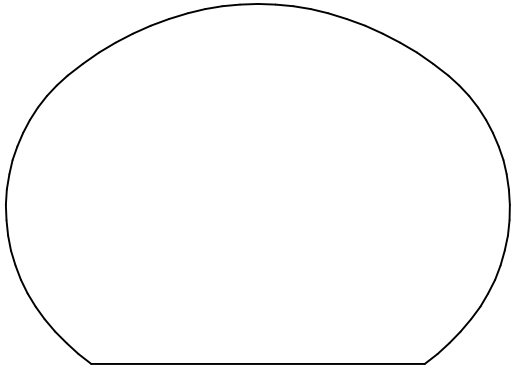

KL 9967
1.875 x 2.625

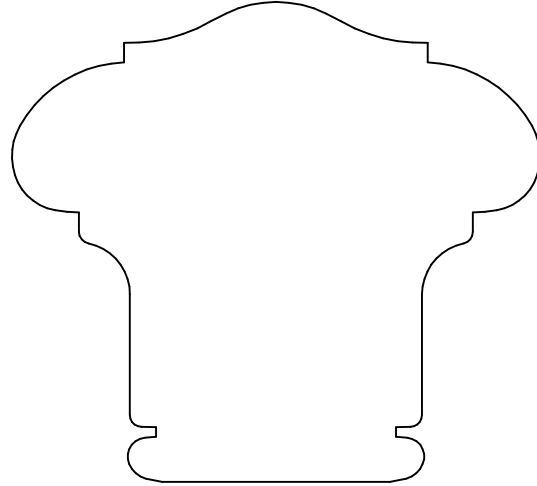

KL 9970
2.500 x 2.750

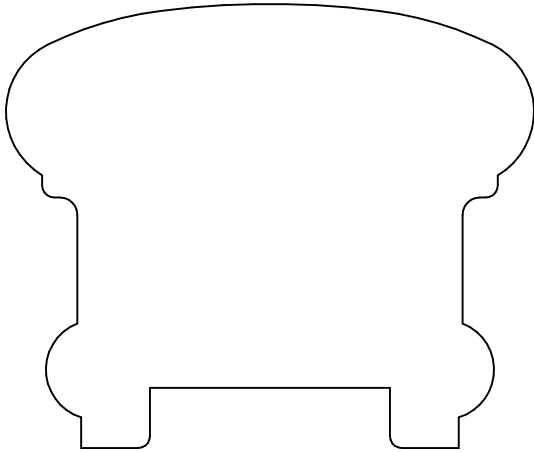

KL 9971 P
2.313 x 2.750

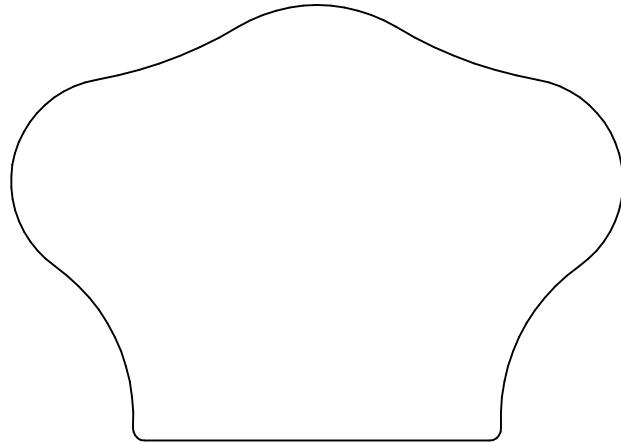

KL 9972
2.269 x 3.188

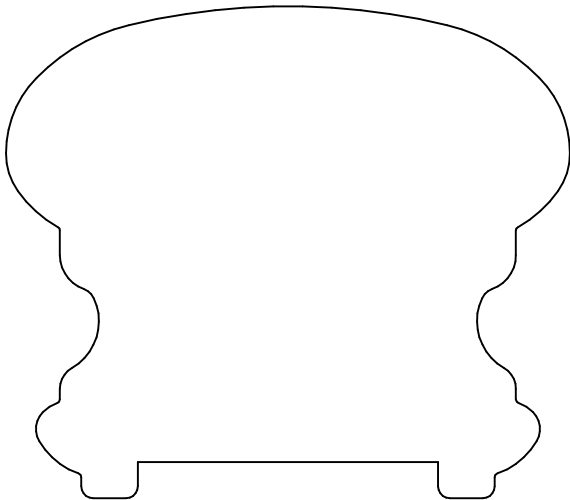

KL 9973P
2.563 x 2.937

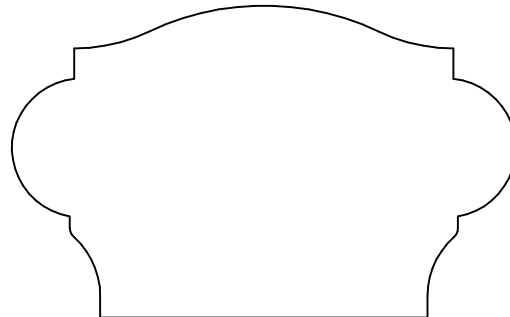

KL 9978
1.625 x 2.625

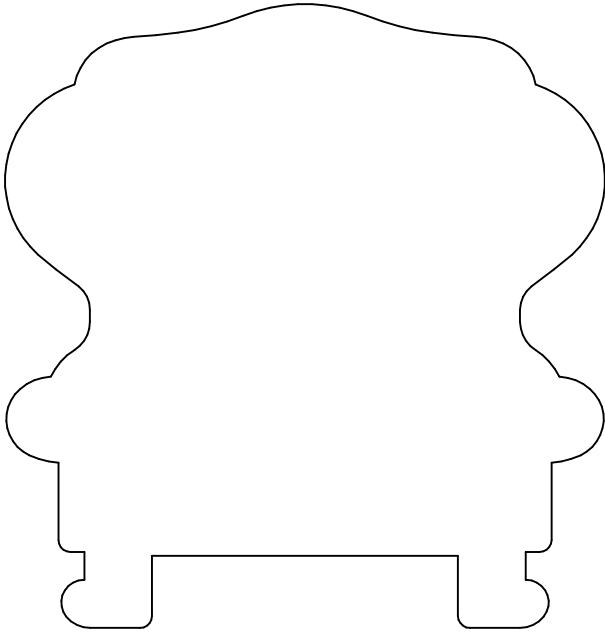

KL 9975P
3.250 x 3.125

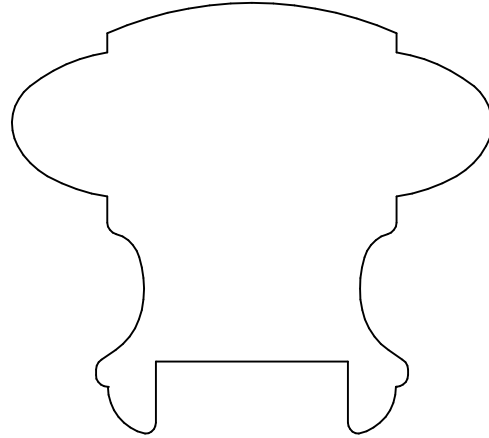

KL 9979P
2.243 x 2.500

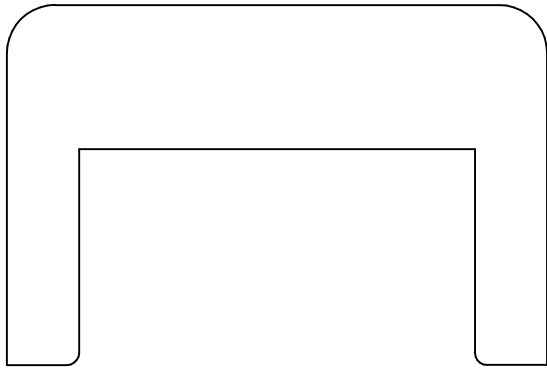

KL 9980P
1.875 x 2.813

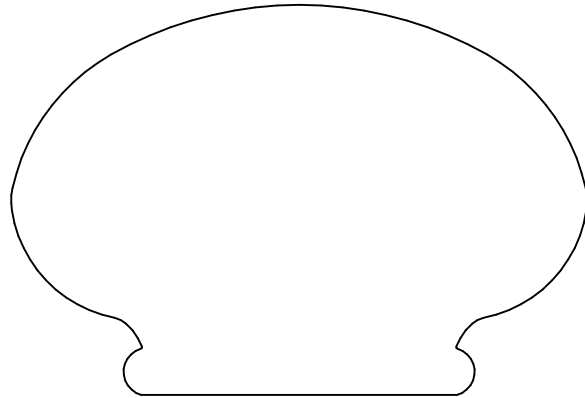

KL 9981
2.031 x 3.000

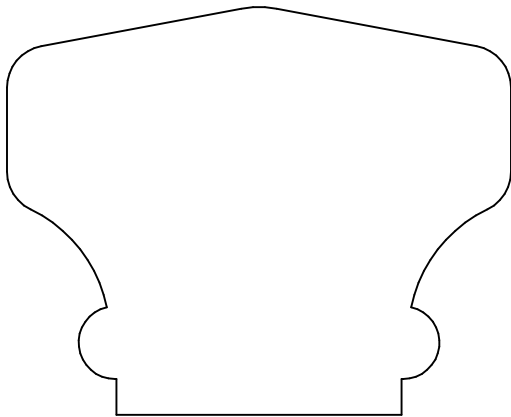

KL 9982
2.125 x 2.625

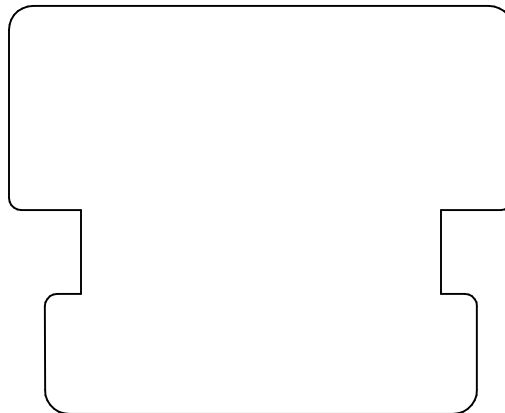

KL 9989
2.125 x 2.625

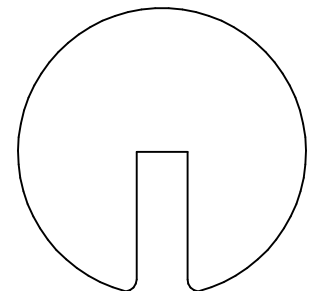

KL 9990 P
1.476 x 1.500

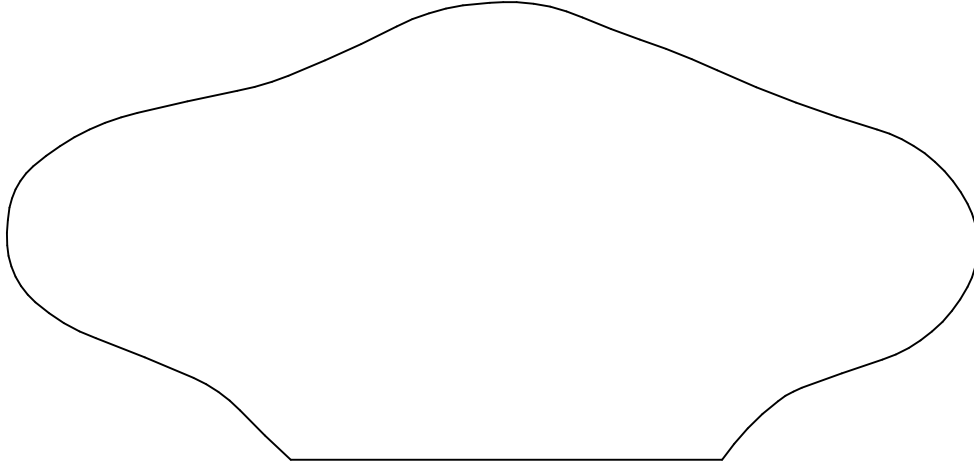

KL 9983
2.385 x 5.056

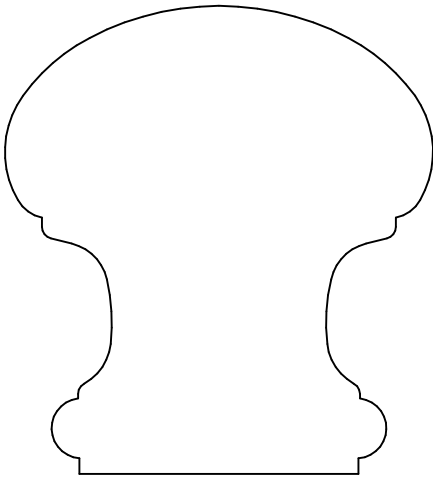

KL 9986
2.438 x 2.229

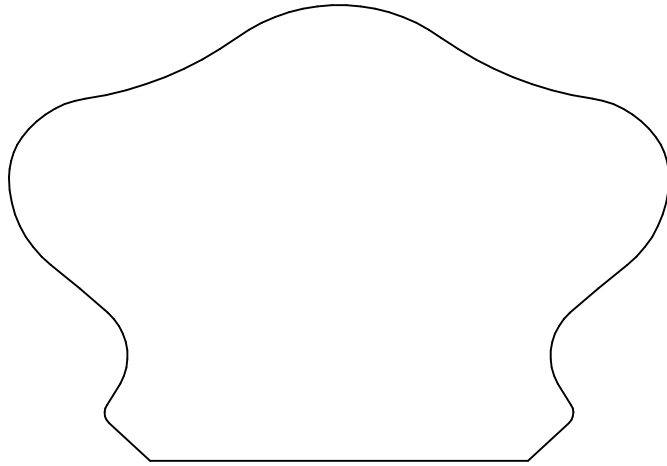

KL 9987
2.375 x 3.438

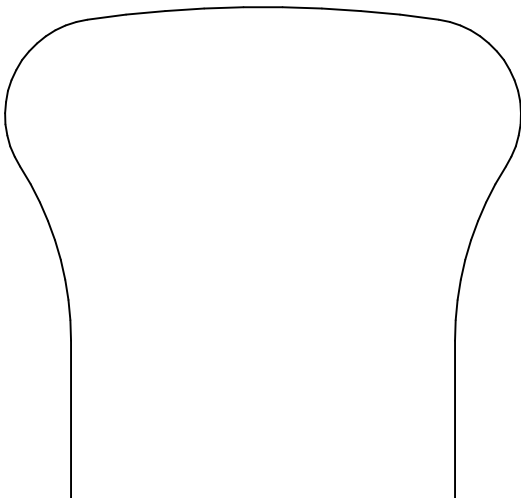

KL 9988
2.563 x 2.688

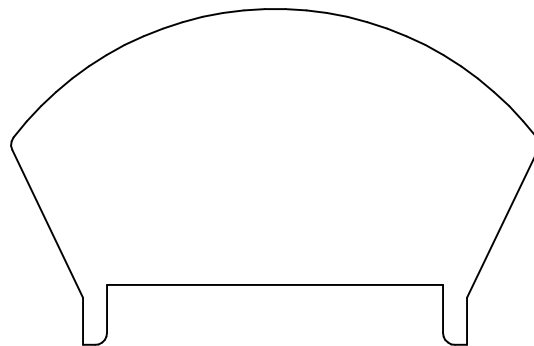

KL 9991P
1.750 x 2.750

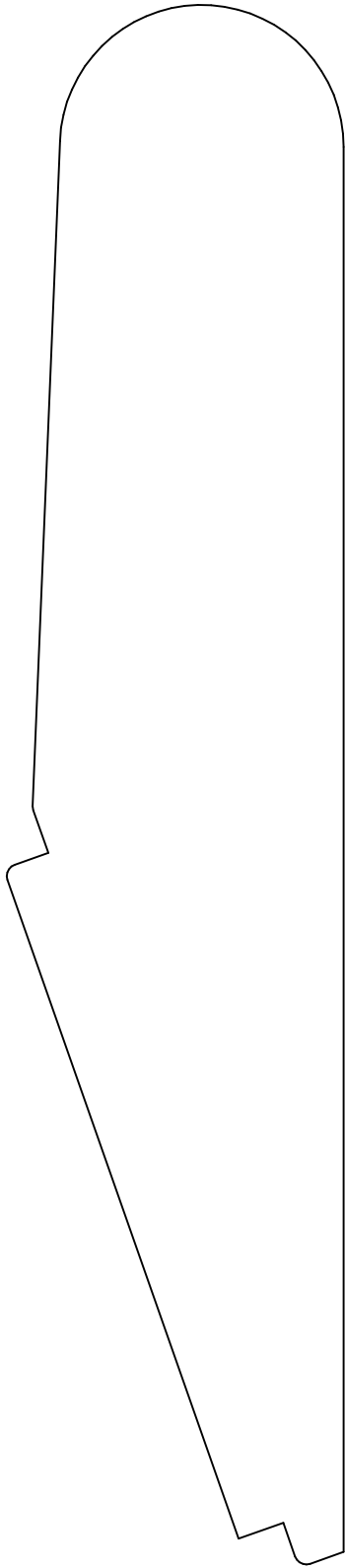

KL 9985
1.779 x 8.236

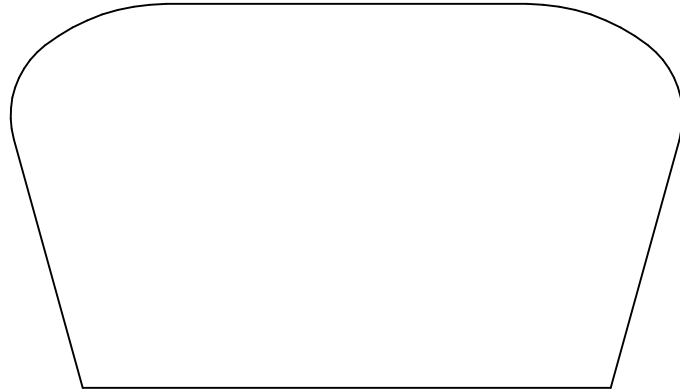

KL 9992
2.000 x 3.500

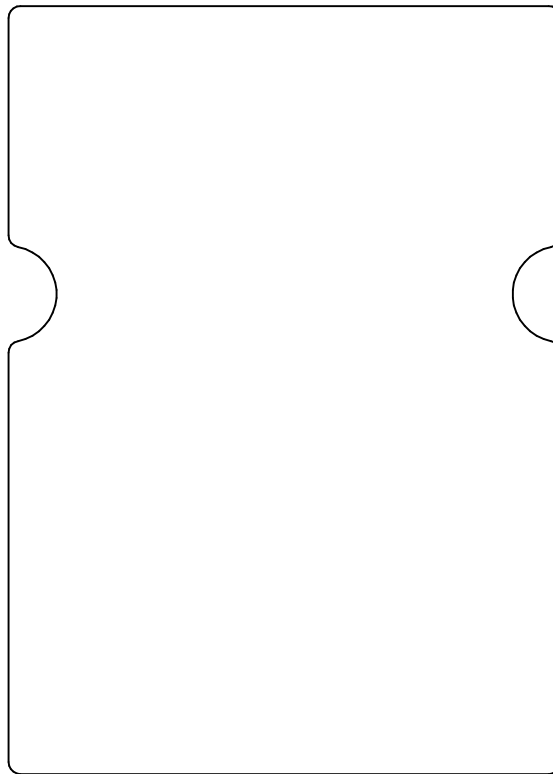

KL 9993
4.000 x 2.875

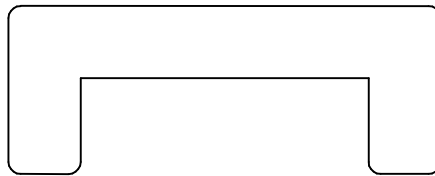

KL 9998P
.875 x 2.250

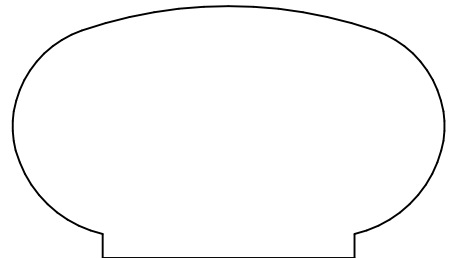

KL 11907
1.313 x 2.250

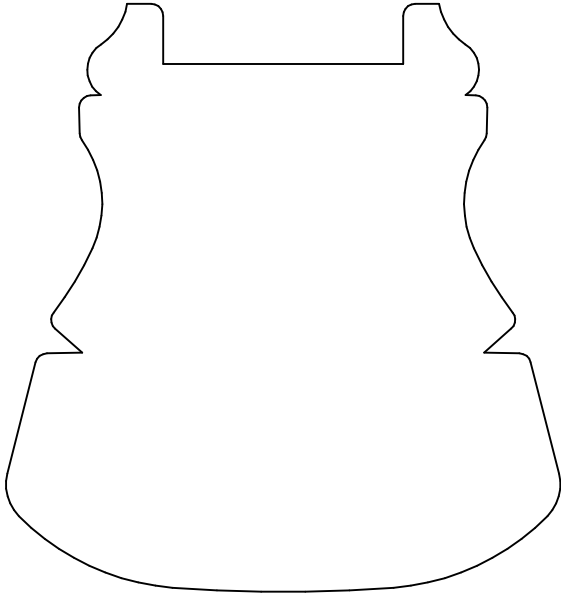

KL 9995P
3.063 x 2.887

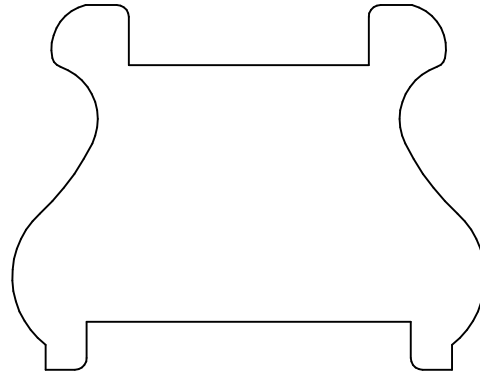

KL 9996P
1.900 x 2.463

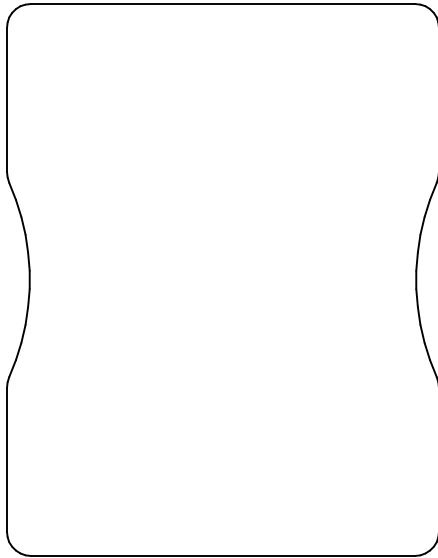

KL 9997
2.875 x 2.250

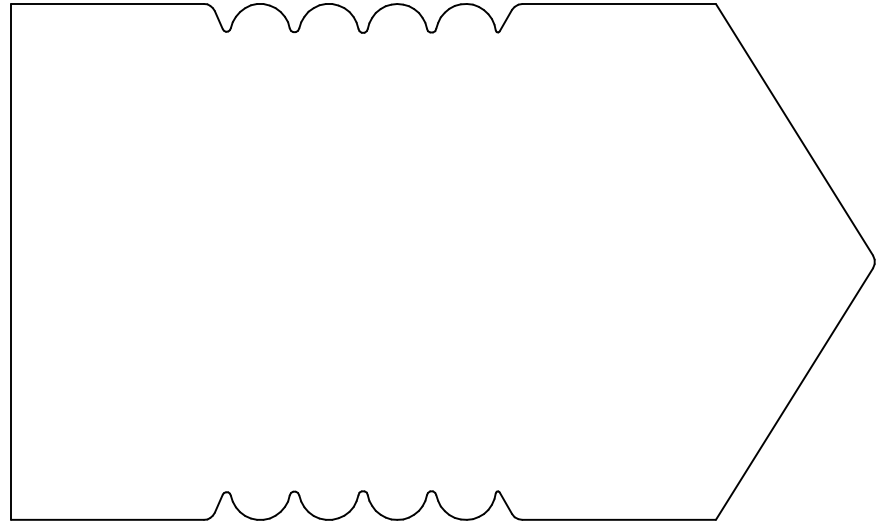

KL 11900
2.688 x 4.500

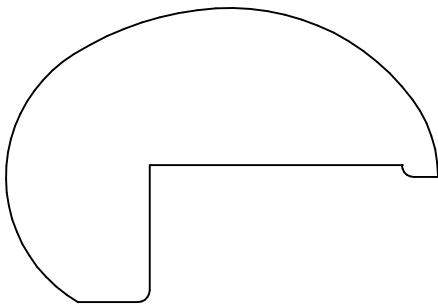

KL 11910
1.532 x 2.250

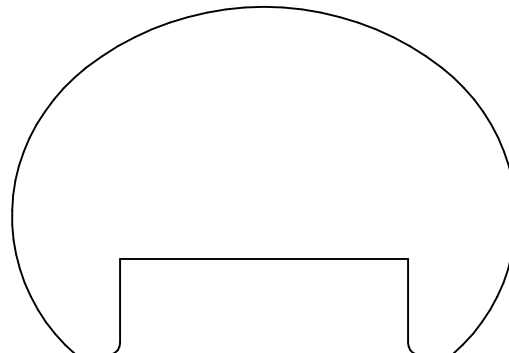

KL 11903P
1.812 x 2.625

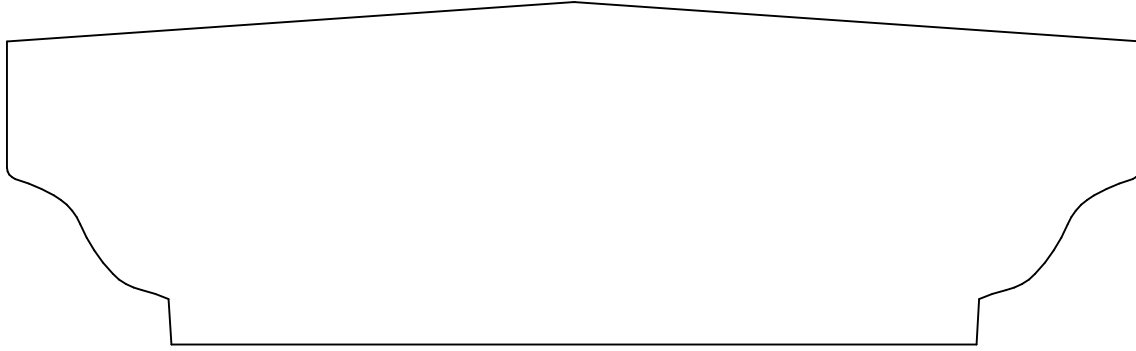

KL 9999
1.784 x 5.906

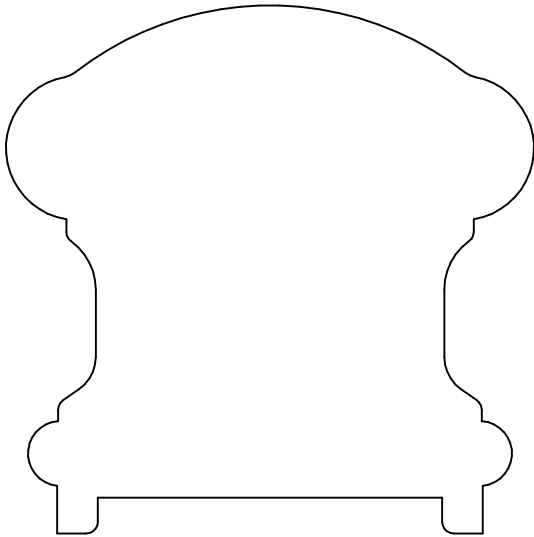

KL 11901P
2.750 x 2.750

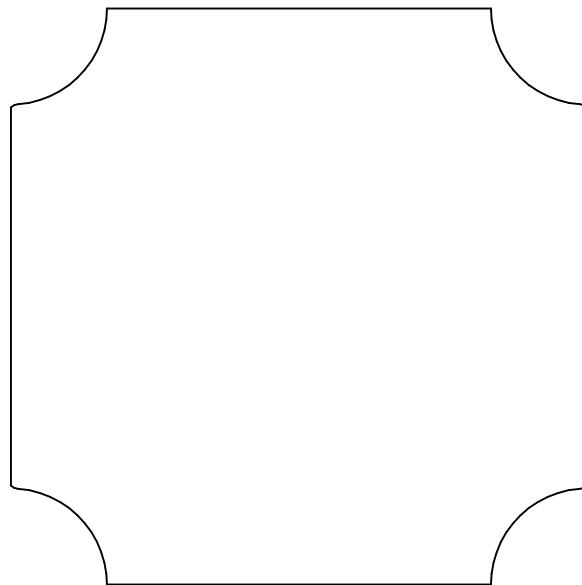

KL 11902
3.000 x 3.000



KL 11904
1.750 x 5.500

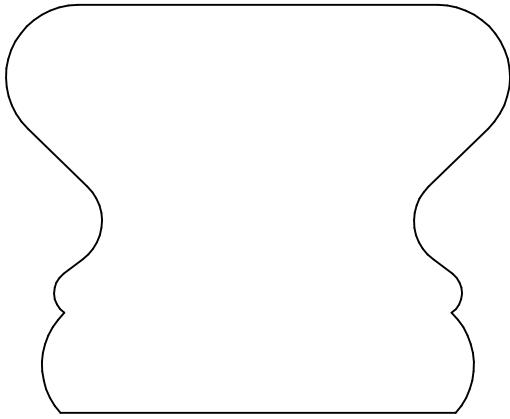

KL 11905
2.125 x 2.625

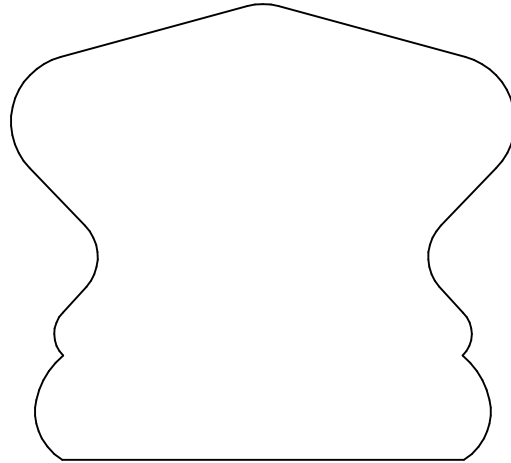

KL 11906
2.375 x 2.625

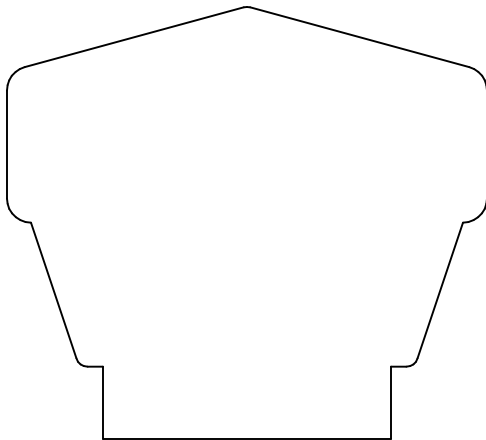

KL 11908
2.250 x 2.500

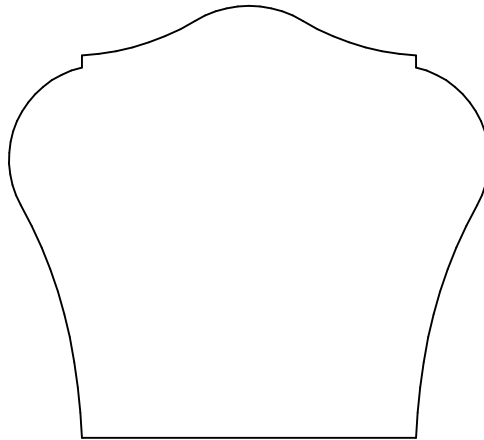

KL 11909
2.250 x 2.500

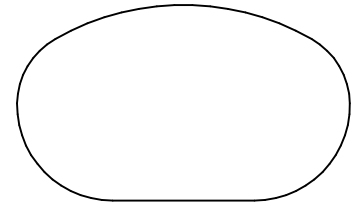

KL 11927
1.019 x 1.734

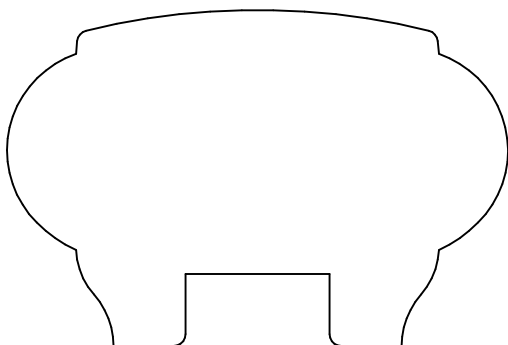

KL 11912P
1.750 x 2.609

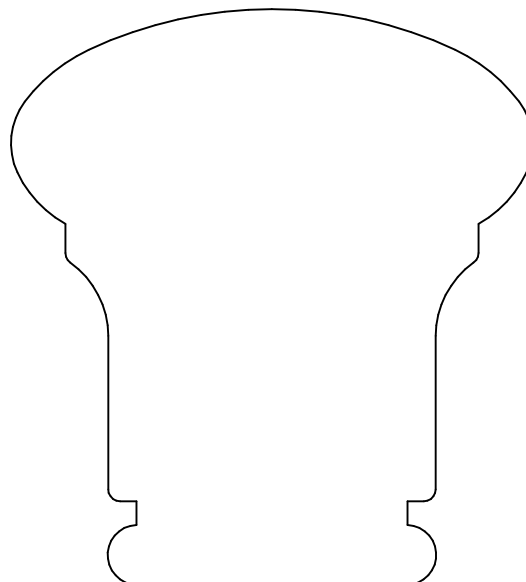

KL 11913
3.000 x 2.719

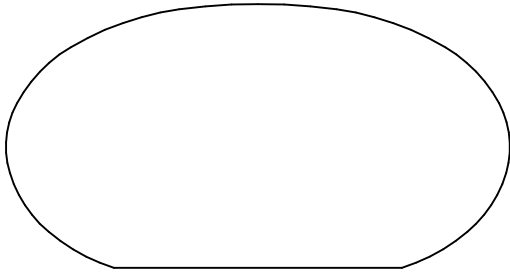

KL 11915
1.375 x 2.625

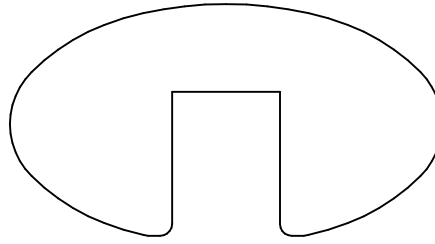

KL 11916P
1.208 x 2.250

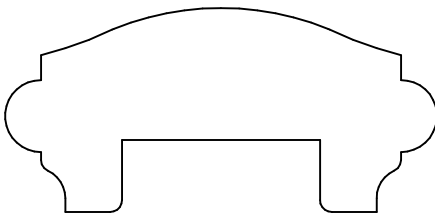

KL 11917P
1.063 x 2.250

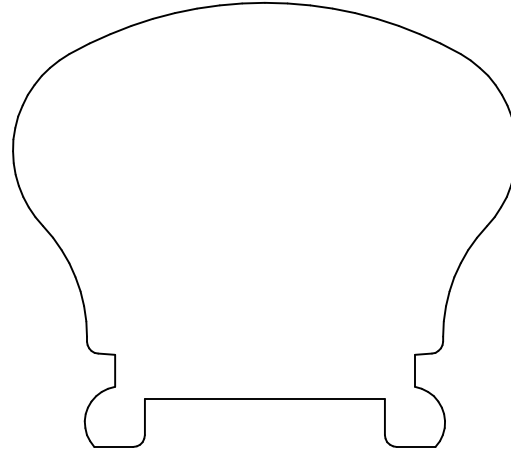

KL 11918P
2.312 x 2.625

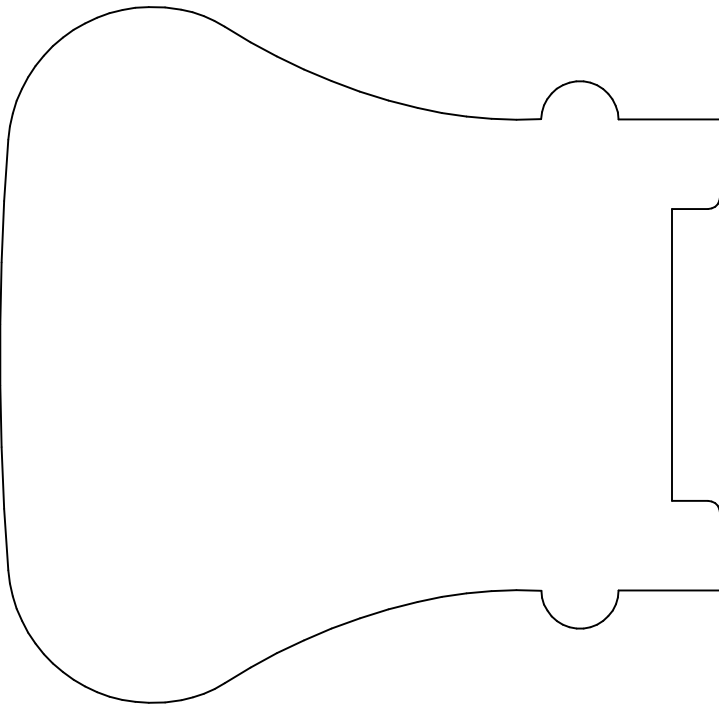

KL 11919P
3.625 x 3.750

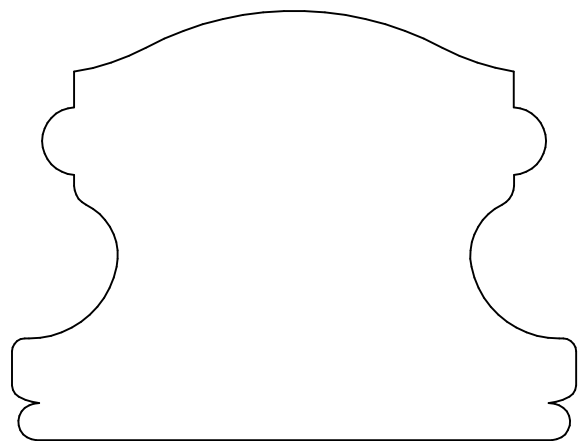

KL 11923
2.235 x 2.938

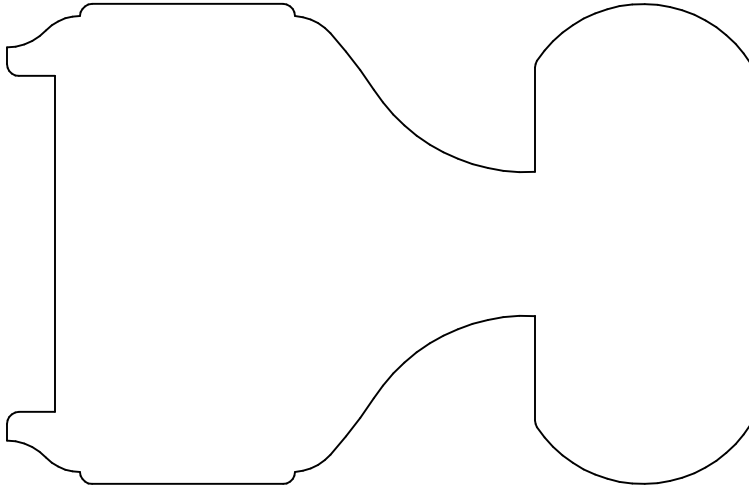

KL 11921 P
2.500 x 3.875

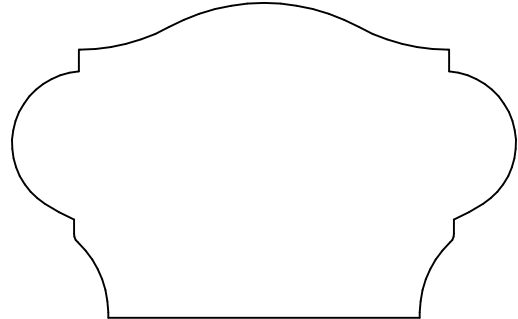

KL 11924
1.640 x 2.625

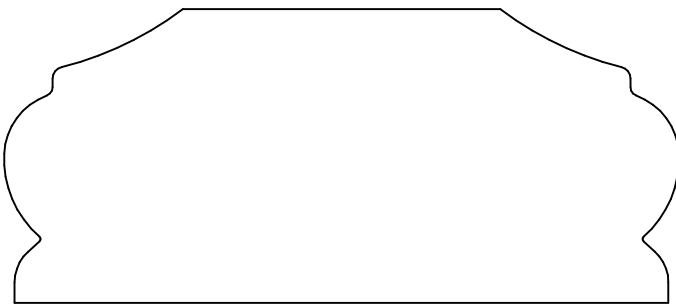

KL 11922
1.531 x 3.516

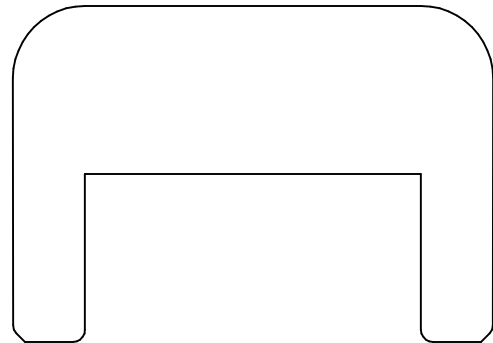

KL 11926P
1.750 x 2.500

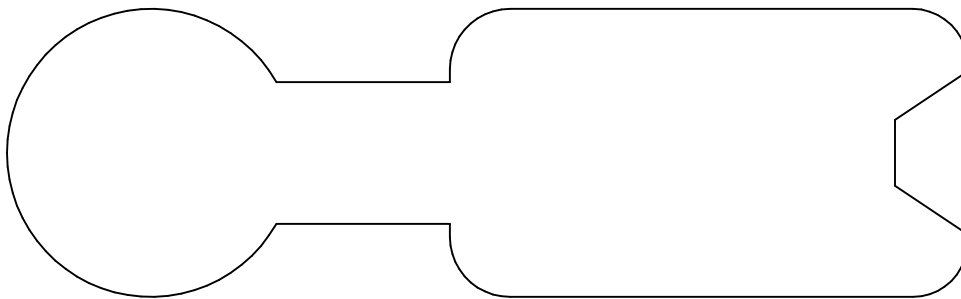

KL 11925P
1.500 x 5.000